

Surgical Instruments Catalogue

- Surgery
- Chirurgie
- Cirugía
- Chirurgie
- Chirurgia



SURGICAL SOURCES INDUSTRIES

We are manufacturer and supplier of Surgical & Dental instruments



M. Rizwan Bajwa
Marketing Directors

Surgical Sources feels great honor introducing itself to be one of the leading manufacturing company of surgical & dental instruments. Professional always prefer **Surgical Sources** instruments, which is our pride.

Our all instruments are manufactured by the high quality stainless steel made on our requirements, every instrument is hand crafted with the highest workmanship available in the industry. Through heat treatment, the instruments are hardened and tempered for proper functioning and long life. All instruments are polished electrolytically and manually for maximum resistance to corrosion and long life.

Surgical Sources pays special attention to the needs of doctors, with innovative designs to meet the needs of professionals. The wide assortment of standard patterns and exclusive **Surgical Sources** designs gives you the most desirable range of surgical and dental instruments.

Over the several years, we have earned the reputation of for maintaining highest quality standards of quality and service. To manufacture instruments that meet with your changing demands is our achievement. Our highly skilled staff of professionals will continue to serve your needs and will try their outmost to uplift the standards which we have set in the past.

With your co-operation and guidance, **Surgical Sources** will continue serving surgical and dental instruments in future.

Management of **Surgical Sources**



Sr. #		Page #	Page #
10	ENT Surgery	290 to 323	
11	Neurosurgery	324 to 339	
12	Intestinal & Rectal Instruments	340 to 351	
13	Gynecology / Obstetrics	352 to 380	
14	Urology Instruments	381 to 390	
15	Hollow Wares	391 to 399	
16	Index	400 to 408	

Sr. #		Page #	Page #
01	Diagnostic Instruments	01 to 14	
02	Trocars, Suction Tubes & Cannulas	15 to 21	
03	Scalpel Handle, Scalpel Blades, Dissecting Knives & Saws	22 to 29	
04	General Operating Scissors	30 to 66	
05	Dressing & Tissue Forceps	67 to 88	
06	Haemostatic Forceps	89 to 123	
07	Needle Holders	124 to 158	
08	Retractors	159 to 210	
09	Bone Surgery Instruments	211 to 289	



DIAGNOSTIC INSTRUMENTS

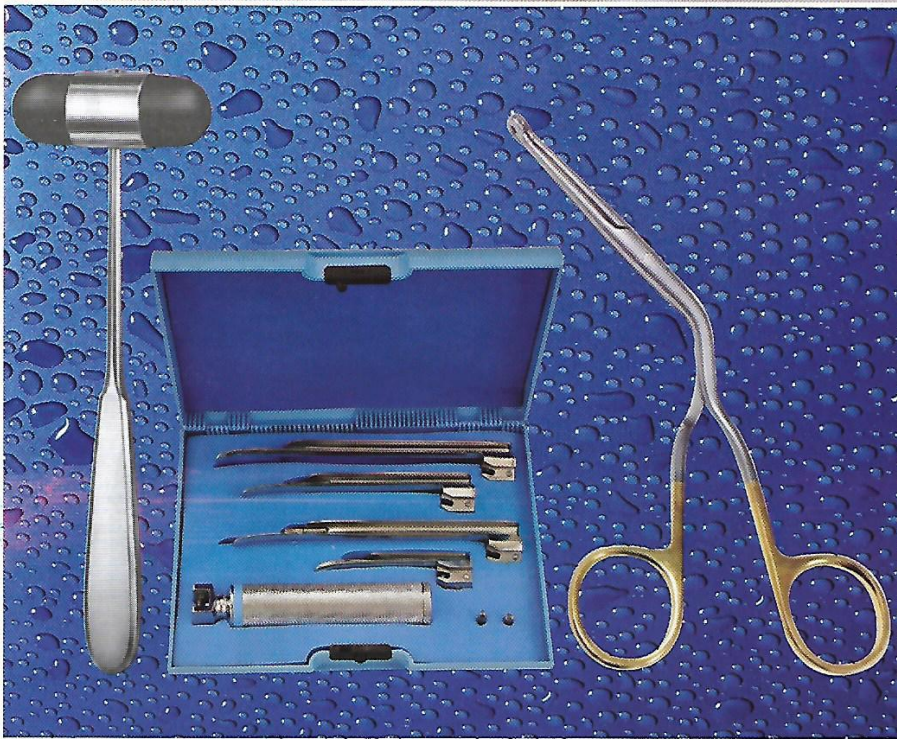



BASIC METHODS FOR HANDLING AND CARE OF SURGICAL AND DENTAL INSTRUMENTS

Dear Customers:

We have received some questions concerning staining, pitting or rusting in stainless steel instruments. So, we took great honour and pleasure in guiding our respected customers to eliminate the problems about staining or rusting etc. The points are as follows:-

- 1) Rinse the instruments as soon as possible after use to remove blood and serum.
- 2) Dry the instruments after cleaning or before wrapping and storing, if not so, moisture left can cause rust and corrosion.
- 3) Do not leave instruments in cold sterilization solution for a long period, as the solution may lead the instrument to be corrosive.
- 4) Never use caustic cleaners, use those specified for cleaning surgical instruments.
- 5) Avoid cleaning instruments with steel wool; if want to clean with hand, use detergent soap and a soft brush and finally treat with distilled water.
- 6) You should check your autoclave; Iron, calcium, sodium or copper in water can cause rusting, staining or corrosion.
- 7) Leaving of instruments for a long time in the following solutions can also cause corrosion.
 - i) Phenol or Iodine.
 - ii) Aluminium, Barium or Calcium.
 - iii) Any Acid, Mercury or Potassium solution.
- 8) Try your utmost not to sterilize stainless steel instrument with chrome plated bras instruments, as any break in chrome surface may cause pitting or rusty surface in instruments.
- 9) Muslin wraps should be rinsed sufficiently by the laundry, so that all chlorine bleach may remove, which can cause corrosion or custing during autoclaving.

We hope that by acting on the above instructions, tour problems relating to rusting, staining or pitting would abolish and the age of your instrument would increase.

MANAGEMENT



STETHOSCOPES

Stethoskope | Estetoscopios
Stéthoscopes | Stetoscopi



DUPLEX, Stethoscope
F1-001
super lightweight



DUPLEX-BABY
Stethoscope
F1-002
super lightweight



ANAESTOPHON
Stethoscope
F1-003
super lightweight



PINARD WOODEN
Stethoscope
F1-004
18 cm, 7"



PINARD ALUMINIUM
Stethoscope
F1-005
15 cm, 6"

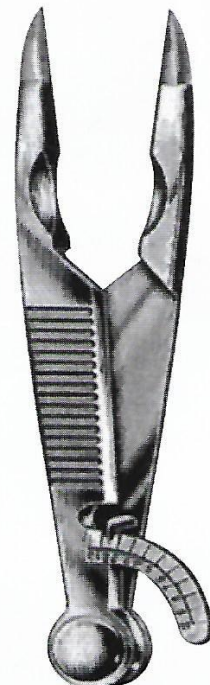

WEBER
Aesthesiometer
F1-006
9.0 cm, 3 1/2"

PERCUSSION HAMMERS



Perkussionshämmer | Martillos de percusión
 Marteaux-percuteurs | Martelli percussori

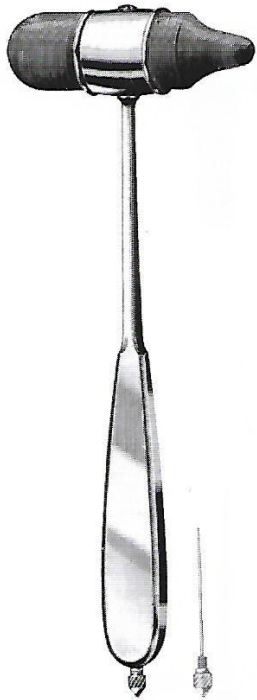

NEURO-DUOFLEX Hammer
 F1-007 22 cm, 8 3/4"



DEJERINE Hammer
 F1-008 20 cm, 8"



DEJERINE Hammer
 F1-009 20 cm, 8"

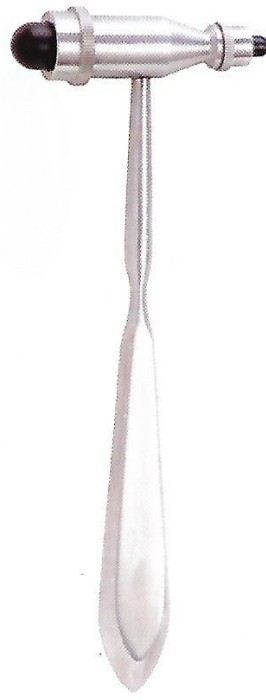

TROEMNER Hammer
 F1-010 145 g
 F1-011 175 g
 F1-012 235 g
 24.5 cm, 9 1/2"
 spare rubber



TROEMNER-SIMPLEX Hammer
 F1-013 21 cm, 8 1/4"



BUCK Hammer
 F1-014 18.5 cm, 7 1/4"



BUCK Hammer
 F1-015 18 cm, 7"



TAYLOR Hammer
 F1-016 18 cm, 7"
 F1-017 20 cm, 8"



TAYLOR Hammer
 F1-018 18 cm, 7"



PERCUSSION HAMMERS

Perkussionshämmer | Martillos de percusión
Marteaux-percuteurs | Martelli percussori

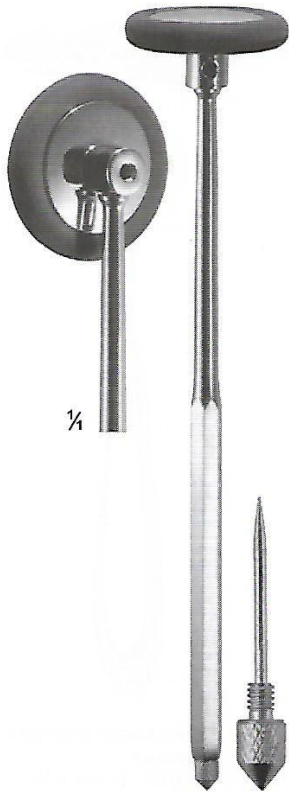

BABINSKY Hammer
F1-019 22 cm, 8 ¾"
Ø 40mm

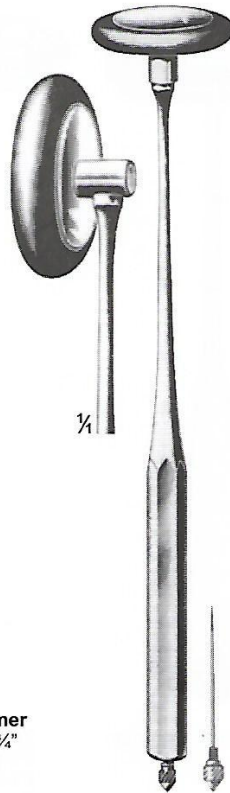

BABINSKY Hammer
F1-020 22 cm, 8 ¾"
Ø 40mm

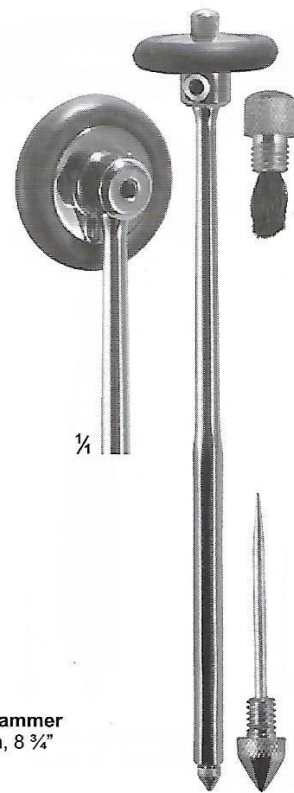

RABINER Hammer
F1-021 23 cm, 9"
Ø 40mm
with needle & brush

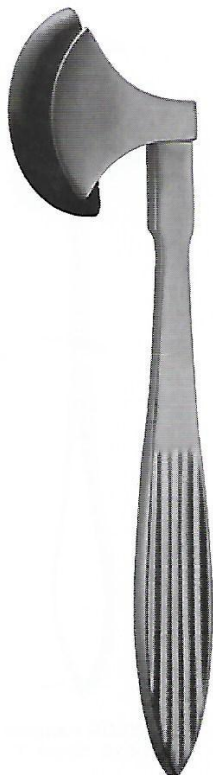

BERLINER Hammer
F1-022 20.0 cm, 8"

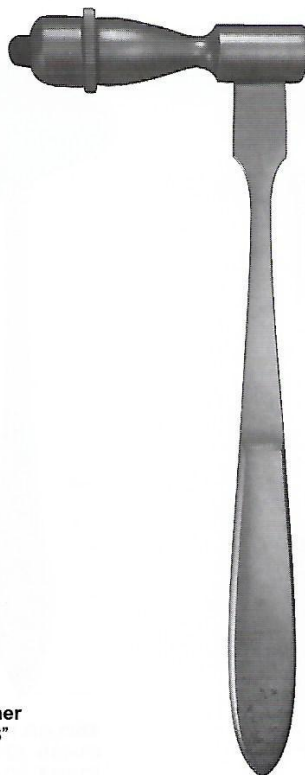

TRAUBE Hammer
F1-023 16 cm, 6 ¼"

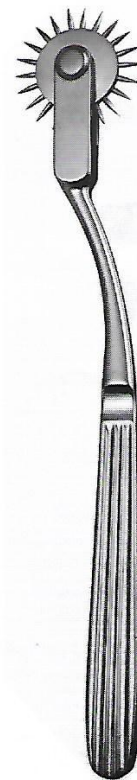

**WARTENBERG
Pinwheel**
F1-024 19 cm, 7 ½"

CATHETER FORCEPS



Katheterzangen

Pinzas para catéteres

Pinzas para sondes

Pinze per cannule

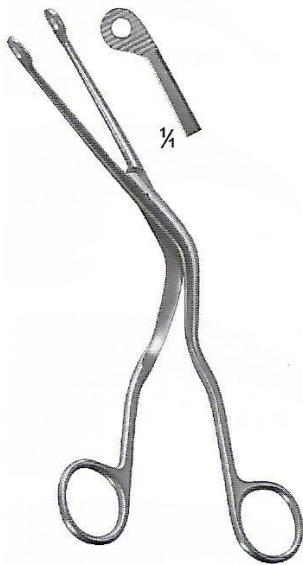

MAGILL
Catheter Intubating
Forcep
F1-025 16 cm, 6 1/4"

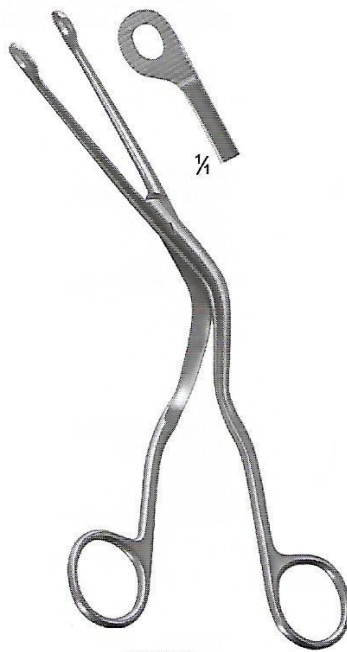

MAGILL
Catheter Intubating
Forcep
F1-026 20 cm, 8"



MAGILL
Catheter Intubating
Forcep
F1-027 25 cm, 10"



MAGILL Catheter Intubating Forcep GOLD
F1-028 6.5" (2.5" shaft) , Infant , hole (dia 2.00 mm)
F1-029 7.5" (3" shaft) , Infant , hole (dia 2.30 mm)
F1-030 7.5" (4" shaft) , Infant , hole (dia 2.60 mm)



MAGILL Catheter Intubating Forcep GOLD
F1-031 8" (4" shaft) , Child , hole (dia 3.00 mm)
F1-032 8" (4" shaft) , Child , oval tip (5.38 mm X 4.15 mm)
F1-033 9" (5" shaft) , Adult , oval (6.80 mm x 5.00 mm)
F1-034 10" (5" shaft) , Adult , oval (9.60 mm x 7.70 mm)



LARYNGOSCOPES

Laryngoskope | Laringoscopios
Laryngoscopes | Laringoscopi

MC-INTOSH FIBER OPTIC LARYNGOSCOPE BLADE (English Pattern)

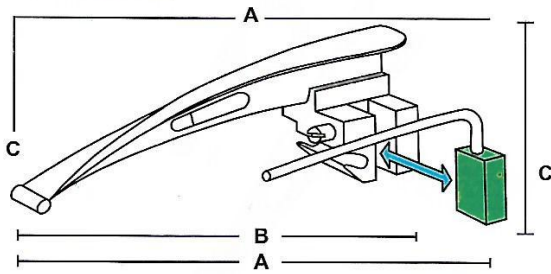

BLADE

Size	A	B	C	Working Length
0	77mm	53mm	14mm	55mm
1	95mm	72mm	43mm	70mm
2	111mm	86mm	44mm	78mm
3	133mm	109mm	44mm	108mm
4	151mm	129mm	44mm	133mm

Mc-Intosh Laryngoscope Fiber Optic
Halogen illumination. Manufactured from AISI 304 Stainless-Steel. Halogen Illumination 2.5 V. The Bulb is inside the handle in order to simplify the sterilization of the blades. All blades and handles are interchangeable with other leading manufacturer. All sets can be combined as per your request, and delivered in Green plastic case.

Blades Availability:

- * Matt Finish
- * Mirror Finish
- * Sand Blast Finish
- * Pls, confirm in your order list

MC-INTOSH FIBER OPTIC LARYNGOSCOPE SET HALOGEN ILLUMINATION

F1-035 PEDIATRIC SET
Set of 0,1,2
Blades
Supplied in
Green plastic case

F1-036 STANDARD SET
Set of 1,2,3
Blades
Supplied in
Green plastic case

F1-037 ADULT SET
Set of 1,2,3,4
Blades
Supplied in
Green plastic case

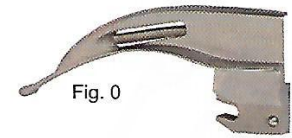

Fig. 0



Fig. 1

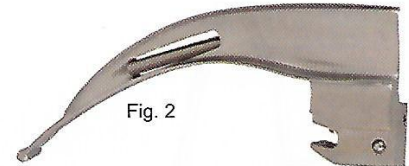

Fig. 2

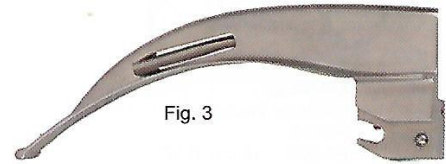

Fig. 3

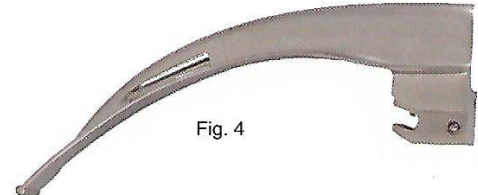

Fig. 4



Laryngoscope Battery
Handle for Adult
C type 2 batteries



Mc-Intosh Fiber Optic Laryngoscope Set
Halogen Illumination
Manufactured by AISI:
304 Stainless Steel Material

LARYNGOSCOPES

Laryngoskope | Laringoscopios
Laryngoscopes | Laringoscopi



MC-INTOSH LARYNGOSCOPE

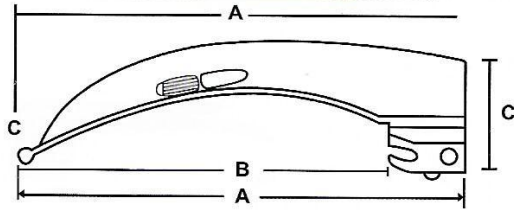

BLADE

Size	A	B	C	Working Length
0	80mm	58mm	30mm	55mm
1	97mm	76mm	36mm	70mm
2	111mm	88mm	36mm	78mm
3	133mm	112mm	36mm	108mm
4	154mm	131mm	38mm	133mm

Mc-Intosh Laryngoscope

Plastic case, Standard illumination. Manufactured from AISI 304 Stainless Steel Matt Type, Standard Illumination 2.5 V. All blades and handles are interchangeable with other leading manufacturer. All sets can be combined as per your request, and delivered in Gray plastic case.

Blades Availability:

- * Matt Finish
- * Mirror Finish
- * Sand Blast Finish
- * Pls, confirm in your order list

Conventional Laryngoscope Set

Mc-INTOSH LARYNGOSCOPE SET STANDARD ILLUMINATION

AVAILABLE SETS WITH BATTERY HANDLE

F1-038 PEDIATRIC SET

Set of 0,1,2
Blades
Supplied in
Gray plastic case

F1-039 STANDARD SET

Set of 1,2,3
Blades
Supplied in
Gray plastic case

F1-040 ADULT SET

Set of 1,2,3,4
Blades
Supplied in
Gray plastic case

Fig. 0

Fig. 1

Fig. 2

Fig. 3

Fig. 4



Laryngoscope Battery
Handle for Adult
C type 2 Batteries



With two Spare
Bulbs



Mc-Intosh Laryngoscope Set
Standard Illumination
Manufactured From
Stainless Steel Material



LARYNGOSCOPES

Laryngoskope | Laringoscopios
Laryngoscopes | Laringoscopi

LARYNGOSCOPE MILLER

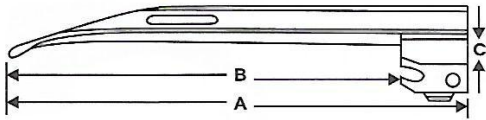

BLADE

Size	A	B	C	Working Length
0	75mm	53mm	26mm	55mm
1	111mm	80mm	26mm	80mm
2	151mm	134mm	28mm	130mm
3	188mm	167mm	28mm	170mm
4	203mm	180mm	28mm	180mm

Mc-Intosh Laryngoscope

Plastic case, Standard illumination.
Manufactured from AISI 304 Stainless Steel.
All blades and handles are interchangeable
with other leading manufacturer. All sets
can be combined as per your request, and
delivered in Blue plastic case.

Blades Availability:

- * Matt Finish
- * Mirror Finish
- * Sand Blast Finish
- * Pls, confirm in your order list

Conventional Laryngoscope Set

LARYNGOSCOPE SET OF CONVENTIONAL MILLER STANDARD ILLUMINATION

AVAILABLE SETS WITH BATTERY HANDLE

**F1-041
PEDIATRIC SET**
Set of 0,1,2
Blades
Supplied in
Blue plastic case

**F1-042
STANDARD SET**
Set of 1,2,3
Blades
Supplied in
Blue plastic case

**F1-043
ADULT SET**
Set of 1,2,3,4
Blades
Supplied in
Blue plastic case



Fig. 1



Fig. 2



Fig. 3



Fig. 4



Laryngoscope Battery
Handle for Adult C type
2 batteries



With two Spare
Bulbs



Laryngoscope Set of conventional Miller
Standard Illumination
Manufactured From Stainless Steel Material

DIAGNOSTIC SETS



Diagnostik-Bestestecke
Trousse à diagnostic

Juegos para diagnóstico
Astucci per diagnostica



**Professional Otoscope & Ophthalmology Set
ENT Medical Diagnostic Set**

F1-044

2.5 V Standard illumination for use with 2 batteries C type.
Including:
Otoscope Head: Luir Lock fitting. Chrome plated.
Fix lens 4 x in plastic mount can be removed for introduction of instruments.
Specula sizes: 2.5, 3.5 & 4.5 mm Included,
Ophthalmoscope head: Luir Lock fitting.
Lens selection wheel permits choice of corrective lenses from 0 to - 20 and 0 to +20 diopters.
Single large circle aperture.
Bent-arm illuminator: pin contact fitting.
Nasal speculum: Chrome plated.
Two laryngeal mirrors: n. 4 and 5.
Battery handle: 28mm. For 2 cell C-batteries. Chrome plated. For adjustment of all illumination.
Replacement bulb: 2.5 V
Diagnostic set is supplied in our new beautiful look and quality Blue Case, which protect our quality Products from moisturizing and damaging.



Handle



Two laryngeal mirrors: n. 4 and 5



Bent-arm illuminator: pin contact fitting.



Specula



With 2 spare Bulbs



Otoscope Head



Nasal speculum: Chrome plated.

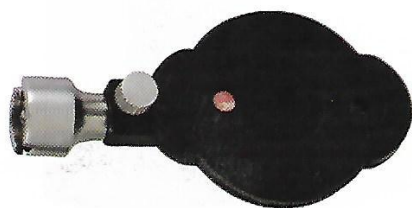

Ophthalmoscope head



ENT Specula



DIAGNOSTIC SETS

Diagnostik-Bestestecke
Trousse à diagnostic

Juegos para diagnóstico
Astucci per diagnostica



DIAGNOSTIC PENTOSCOPE SET F1-045

2.5 V Standard illumination for use with 2 batteries type AA.

Consisting:

Universal Handle thread type fit for all Pentoscope Heads like.

- Otoscope Head.
- Ophthalmoscope Head.
- Throat Branch Head.
- Mouth Mirrors Head.

It have two exploring mirrors No. 4 & 5 mm.

Its spare 06 disposable Plastic ear Canulas are with sizes 2 x 2.50 mm, 2 x 3.50 mm & 2 x 4.5 mm.

On special order it can be as 2 x 1.5 mm for new born babies 2 x 2.5 mm for pediatric and 2 x 4 mm for adults, so it means total 06 canula also available in a plastic tube packing.

Sturdy adjustment mount bracket

2 spare 2.5 V bulb.

Pentoscope set battery handle is operating with two AA size batteries.

This Pentoscope set Packed in our new beautiful Blue Colour plastic case in same blue inner packing material.

Spare parts also available of any item.

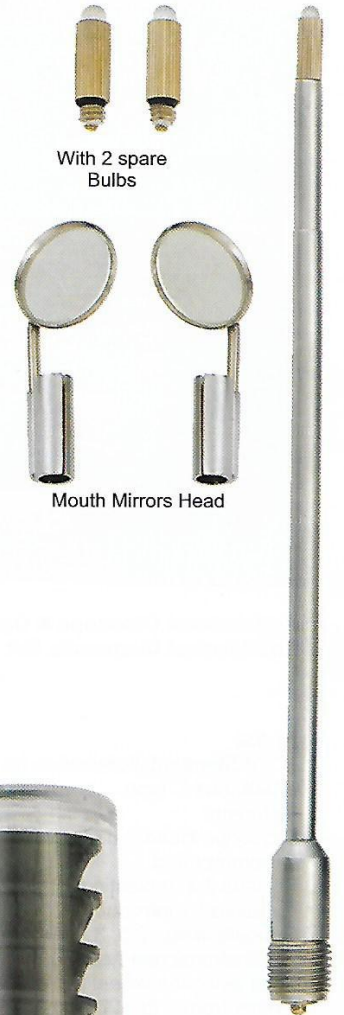

With 2 spare Bulbs

Mouth Mirrors Head

Standard illumination



Otoscope Head



Sturdy Adjustment Mount Bracket



Plastic ear Canulas

DISSECTING KITS



Diagnostik-bestecke

Diagnostic Setts

Estuches de diagnostico

Combinazioni per diagnostica

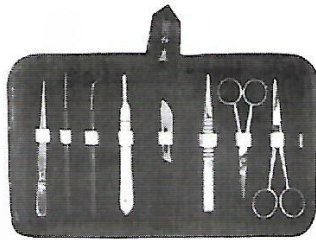

F1-046

Dissecting Set of 9 Pcs.

- Dissecting Forceps 11.5cm Sharp Point.
- Teasing needle Sharp STR.
- Teasing Needle Sharp Angular.
- B.P Handle No.4.
- Blade No. 22.
- Thumb Forcep T.O.E 13cm.
- Dissecting Scissor STR 11.5cm.
- Dissecting Scissor STR 13cm.
- Zipper Case Inside Red Velvet.

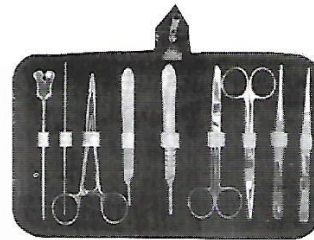

F1-047

Dissecting Set of 10 Pcs.

- Grooved Director with Tongue Tie 14cm.
- Probe Double 14cm.
- Mayo Hegar Needle Holder 14cm.
- B.P Handle No.3
- B.P Handle No.4
- Dressing Scissor 14cm S/B STR.
- Dressing Scissor 14cm S/B CVD.
- Dressing Forcep 1x2 teeth 14cm.
- Dressing Forcep Serrated 14cm.
- Zipper Case Inside Red Velvet.

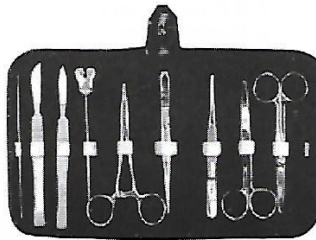

F1-048

Dissecting Set of 10 Pcs.

- Probe Double 13cm.
- 2PCS. Scalpel S.S.
- Grooved Director With Tongue Tie 14cm
- Mayo Hegar Needle Holder 14cm.
- Dissecting Forceps 14cm 1x2 Teeth.
- Dressing Forceps 14cm Serrated.
- Dressing Scissor 14cm S/B STR.
- Dressing Scissor 14cm S/B CVD.
- Zipper Case Inside Red Velvet.

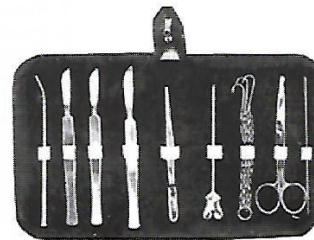

F1-049

Dissecting Set of 10 Pcs.

- Blow Pipe.
- 3PCS Scalpel.
- Dissecting Forceps 14cm.
- Grooved Director With Tongue Tie 14cm
- Triple Chain Hook.
- Dressing Scissor Probe Pointed 14cm.
- Probe Double 14 cm.
- Zipper Case Inside Red Velvet.

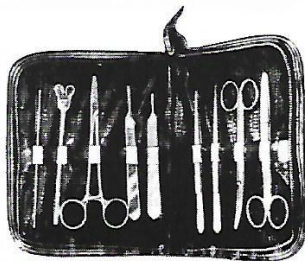

Dissecting Set

F1-050 Containing 9 Instruments

- slice Needle
- Probe Butterfly
- Needle Holder
- Scalpel Handle 3
- Scalpel Handle 4
- Dressing Forceps
- Tissue Forceps
- Tonsil Scissors
- Dressing Scissors

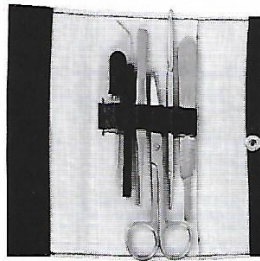

F1-051

Dissecting Set of 6 pcs.

- Dropper Oil
- Probe Plastic Handle
- Dressing Forceps
- Dressing Scissors S/s
- Hook
- Scalpel Handle 4

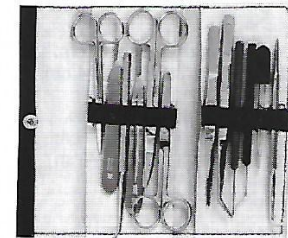

F1-052

Dissecting Set of 12 pcs.

- Iris Scissors
- Scalpel Knives 4
- Probe Single Ended
- Scalpel Handle 3
- Dressing Scissors S/s
- Dressing Scissors S/b
- Dressing Forceps
- College Tweezer
- Probe Straight Plastic Handle
- Probe Angular Plastic Handle
- Dropper Owl
- Hook



DISSECTING KITS

Diagnostik-bestecke

Diagnostic Setts

Estuches de diagnostico

Combinazioni per diagnostica

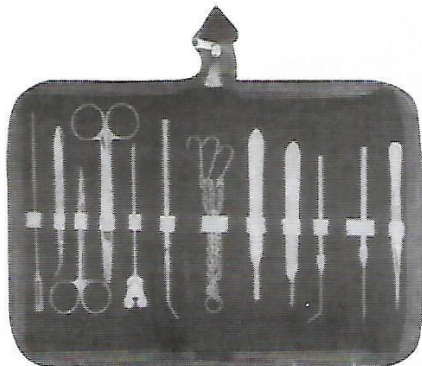

F1-053

- 1- Probe with eye
- 2- Dissecting Forcep CVD Fine 12 cm.
- 3- Iris Scissor
- 4- Operating Scissor S/B STR 14 cm
- 5- Grooved Director and Tongue tie
- 6- Huber Probe
- 7- Triple Chain Hook
- 8- B.P. Handle No. 4
- 9- B.P. Handle No. 3
- 10- Teasing Needle with Chuck CVD.
- 11- Teasing Needle with Chuck STR.
- 12- Dissecting Forceps Fine 14 cm.

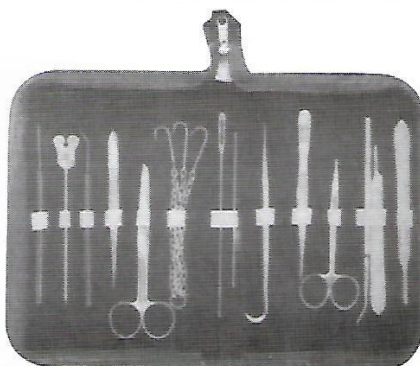

F1-054

- 1- Teasing Needle STR.
- 2- Grooved Director and Tongue Tie.
- 3- Teasing Needle CVD.
- 4- Dissecting Forcep with Pin 12 cm Fine
- 5- Operating Scissor S/B STR 14 cm
- 6- Triple Chain Hook
- 7- Probe with eye
- 8- Probe Double end
- 9- Probe and Hook
- 10- Dissecting Forcep Fine 14 cm
- 11- Iris Scissor
- 12- Huber Probe
- 13- B.P. Handle No.3
- 14- B.P. Handle No.4

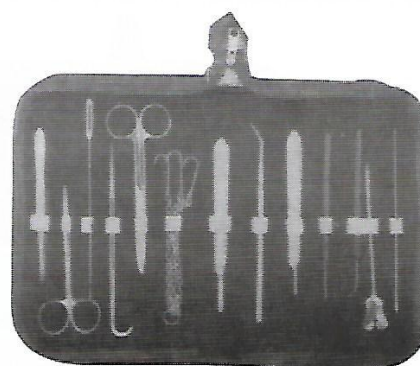

F1-055

- 1- Dissecting Forcep Fine STR with pin 12cm.
- 2- Iris Scissor STR.
- 3- Probe with eye.
- 4- Probe and Hook.
- 5- Operating Scissor S/B STR 14cm
- 6- Triple Chain Hook.
- 7- B.P. Handle No.4
- 8- Humber Probe.
- 9- B.P. Handle No.3
- 10- Teasing Needle STR Plasic Handle.
- 11- Teasing Needle CVD Plasic Handle.
- 12- Grooved Director and Tounge Tie.
- 13- Probe Double end.

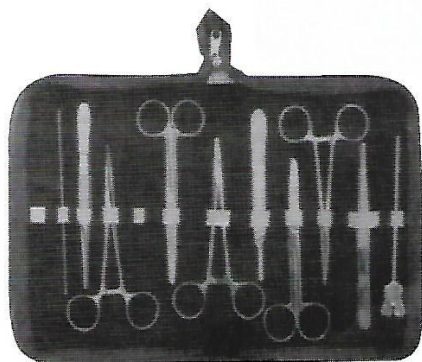

F1-056

- 1- Dissecting Forceps Thumb 14 cm.
- 2- Dissecting Forcep 1x2 Teeth 14 cm.
- 3- B.P. Handle No. 3
- 4- Grooved Director and Tongue tie
- 5- Mayo Hegar Needle Holder 14 cm
- 6- Operating Scissor S/B STR 14 cm
- 7- Probe Double end
- 8- Kelly Forcep STR 14 cm.

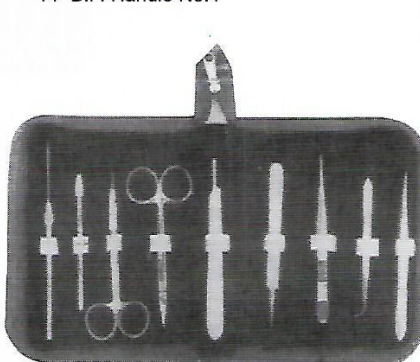

F1-057

- 1- Dissecting Forcep Fine 14cm.
- 2- Dissecting Forcep Fine CVD 12cm
- 3- Dissecting Forcep with Pin 14cm.
- 4- Watchmaker Fine point
- 5- Iris Scissor STR
- 6- Iris Scissor CVD.
- 7- Teasing Needle Holder
- 8- Teasing Needle STR.
- 9- B.P. Handle no. 3

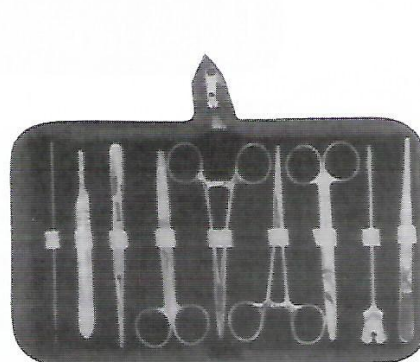

F1-058

- 1- Probe Double end
- 2- B.P. Handle No. 4
- 3- Dissecting Forcep 1x2 Teeth 14 cm.
- 4- Operating Scissor S/B STR 14 cm
- 5- Mayo Hegar Needle Holder 14 cm
- 6- Kelly Forcep STR 14 cm.
- 7- Operating Scissor S/B CVD 14 cm
- 8- Grooved Director and Tongue tie
- 9- Dissecting Forceps Thumb 14 cm.

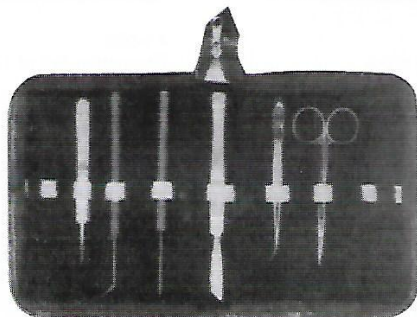

F1-059

- 1- Iris Scissor STR
- 2- Dissecting Forceps CVD 12 cm.
- 3- Scapel
- 4- Teasing Needle STR wooden Handle.
- 5- Teasing Needle CVD wooden Handle.
- 6- Watchmaker fine point.

DISSECTING KITS



Diagnostik-bestecke
Estuches de diagnostico

Diagnostic Setts
Combinazioni per diagnostica

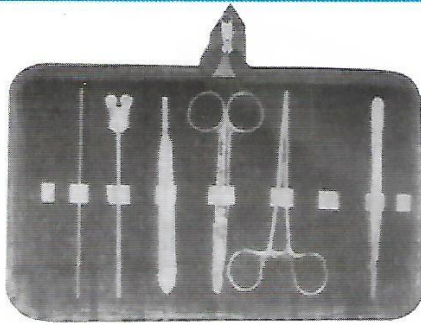

F1-060

- 1- Probe Double end.
- 2- Grooved Director and Tongue tie
- 3- B.P. Handle No. 4
- 4- Operating Scissor STR S/B 14 cm.
- 5- Kelly Forceps STR 14 cm.
- 6- Dissecting Forceps Thumb 13 cm.

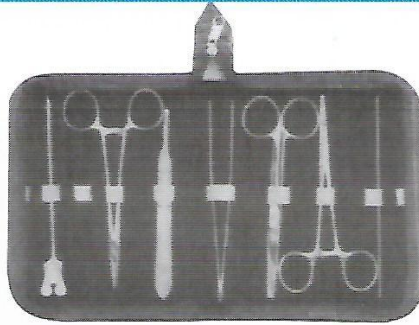

F1-061

- 1- Grooved Director and Tongue tie
- 2- Mayo Hegar Needle Holder 14 cm
- 3- B.P. Handle No. 4
- 4- Dissecting Forceps Thump 14 cm.
- 5- Operating Scissor S/B STR 14 cm
- 6- Kelly Forcep STR 14 cm.
- 7- Probe Double end

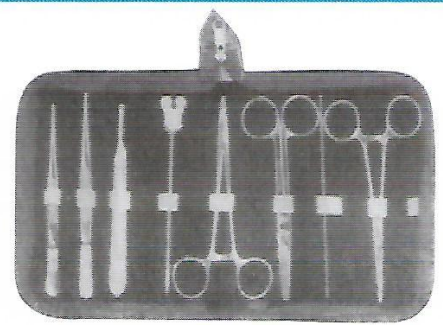

F1-062

- 1- Dissecting Forceps Thumb 14 cm
- 2- Dissecting Forcep 1x2 Teeth 14 cm.
- 3- B.P. Handle No. 3
- 4- Grooved Director and Tongue tie
- 5- Mayo Hegar Needle Holder 14 cm
- 6- Operating Scissor S/B STR 14 cm
- 7- Probe Double end
- 8- Kelly Forcep STR 14 cm.

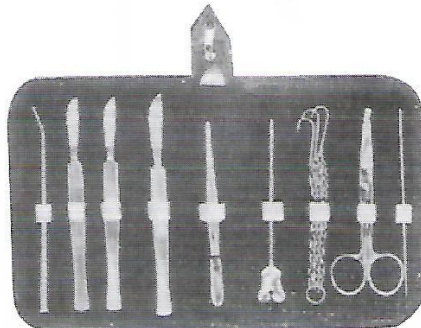

F1-063

- 1- Blow pipe.
- 2- 3 PCS Scalpel.
- 3- Dissecting Forcep 13 cm.
- 4- Grooved Director with Tongue tie 13 cm.
- 5- Triple Chain Hook.
- 6- Dressing Scissors probe pointed 13 cm.
- 7- Probe Double 13 cm.
- 8- Zipper Case inside red velvet.

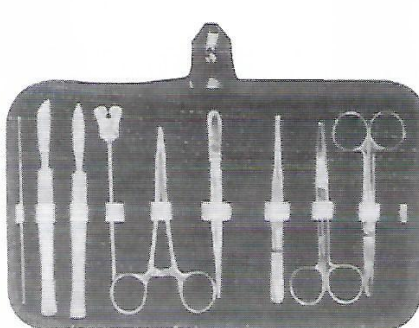

F1-064

- 1- Probe Double 13 cm
- 2- 2 PCS. Scalpel S.S
- 3- Grooved Director with Tongue Tie 13 cm
- 4- Mayo Hegar Needle Holder 13 cm
- 5- Dissecting Forcep 13 cm 1x2 Teeth
- 6- Dressing Forcep 13 CMS Serrated.
- 7- Dressing Scissor 13 cm S/B STR.
- 8- Dressing Scissor 13 cm S/B CVD.
- 9- Zipper Case Inside Red Velvet.

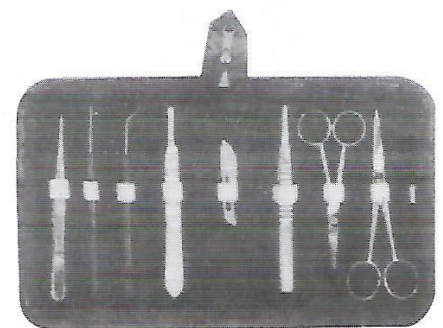

F1-065

- 1- Dissecting Forcep 11.5 cm Sharp Point.
- 2- Iris Scissor
- 3- B.P. Handle No. 4
- 4- Teasing Needle Sharp angular.
- 5- Blade No. 22
- 6- Thumb Forceps T.O.E 13 cm
- 7- Dissecting Scissor STR 11.5 cm
- 8- Dissecting Scissor STR 13 cm
- 9- Zipper case Inside Red Velvet

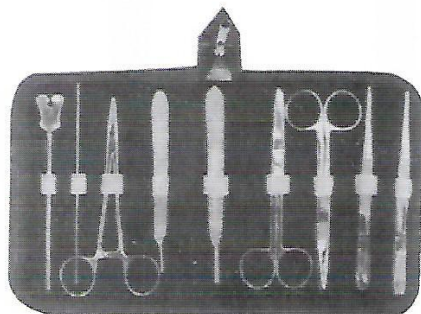

F1-066

- 1- Grooved Director with Tongue Tie 14 cm
- 2- Probe Double 14 cm
- 3- Mayo Hegar Needle Holder 14 cm
- 4- B.P. Handle No. 3
- 5- B.P. Handle No. 4
- 6- Dressing Scissor 14 cm S/B STR
- 7- Dressing Scissor 14 cm S/B CVD.
- 8- Dressing Forcep 1x2 Teeth 14 cm
- 9- Dressing Forcep Serrated 14 cm

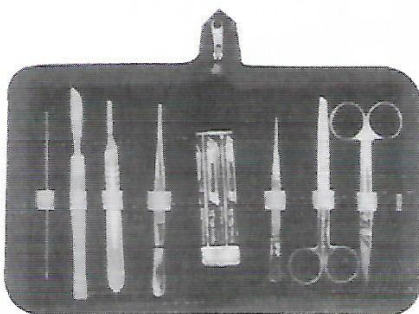

F1-067

- 1- Probe Double 12.5 cm
- 2- Scalpel
- 3- B.P. Handle No. 4
- 4- 6 PCS Blade 2 Each No. 21, 22, 23
- 5- Dissecting Forcep 12.5 cm
- 6- Dissecting Forcep 11.5 cm Sharp Point
- 7- Dissecting Scissor S/B STR 13 cm
- 8- Dissecting Scissor S/S STR 13 cm

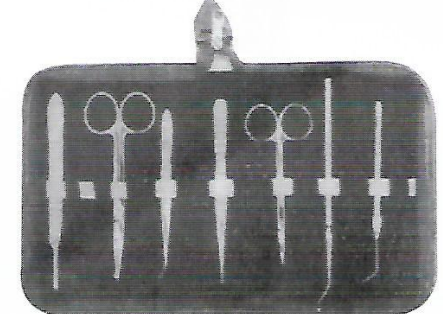

F1-068

- 1- Teasing Needle with Chuck CVD.
- 2- Huber Probe
- 3- Iris Scissor
- 4- Dissecting Forcep Fine 14 cm.
- 5- Dissecting Forcep Fine CVD. 12 cm
- 6- Operating Scissor with Probe 14 cm.
- 7- B.P. Handle No. 4



MEASURING INSTRUMENTS

Messinstrumente
Instruments pour mesurer

Instrumentos para medidas
Strumenti per misurare



F1-069
15 cm, 6"
cm & mm
markings

**GRADUATED
METAL RULER**

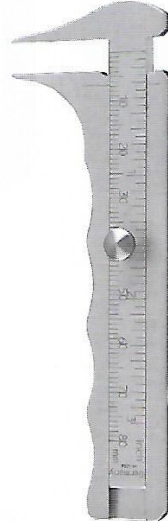

**JAMESON
CALIPER
F1-070**
8 cm, 3"



**TOWNLEY
CALIPER
F1-071**
10 cm, 4"

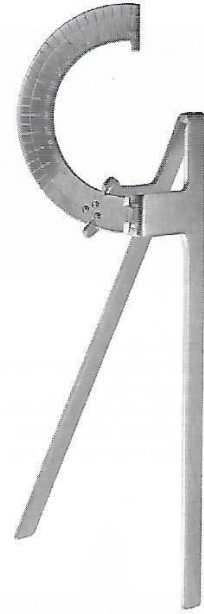

**MÖELTGEN
CALIPER
F1-072**

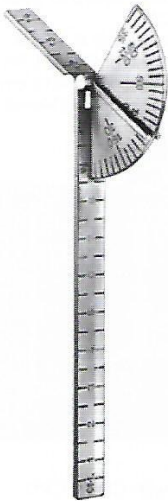

**CAROLL
POCKET GONIOMETER
F1-073**
14.5 cm, 5 3/4"

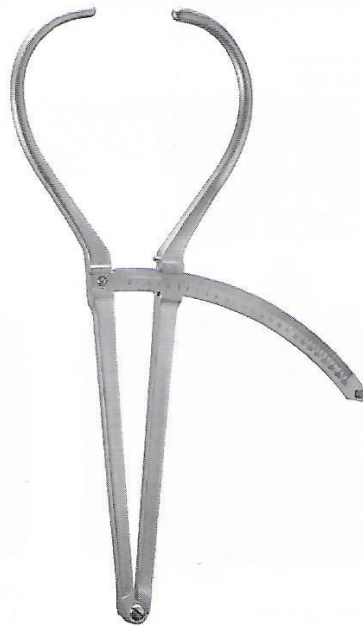

**BERTILLON
MEASURING DEVICE
F1-074**
32cm 12 1/2"

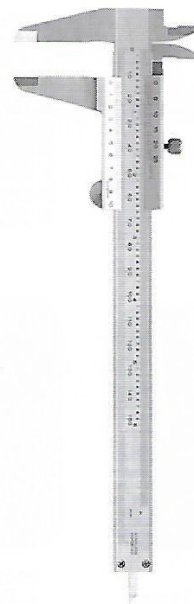

**VERNIER CALIPER
F1-075**
15 cm, 6"



**VERNIER CALIPER
F1-076**
15 cm, 6"
Fine Point

MEASURING INSTRUMENTS

Messinstrumente
Instruments pour mesurer

Instrumentos para medidas
Strumenti per misurare

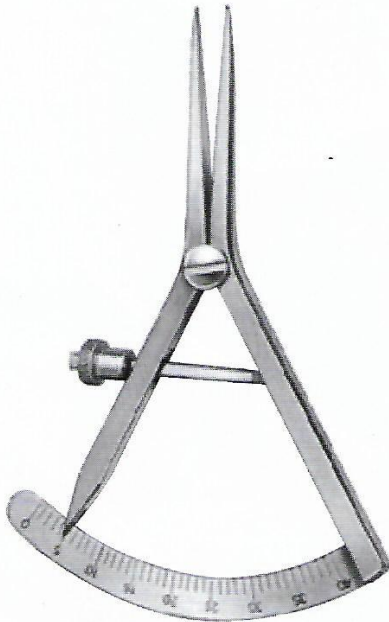

CASTROVIEJO-EPKER

Caliper

F1-077 9 cm, 3 1/2", Str.

Measuring range, 40 mm

F1-078 9 cm, 3 1/2", Cvd.

Measuring range, 40 mm

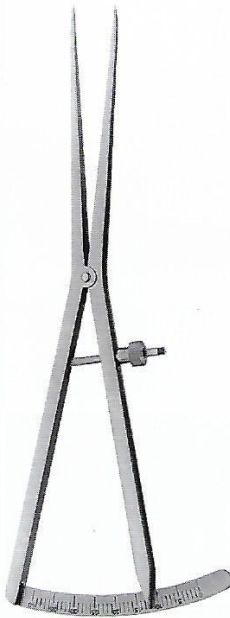

CASTROVIEJO-EPKER

Caliper

F1-079

18 cm, 7"

Measuring range

40 mm, straight

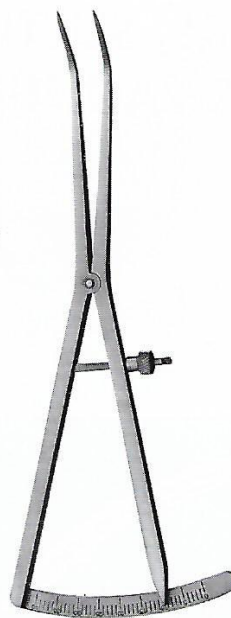

CASTROVIEJO-EPKER

Caliper

F1-080

18 cm, 7" Angled

Measuring range

40 mm



CASTROVIEJO

F1-081

Bone Caliper 7"

Straight



CASTROVIEJO

F1-082

Bone Caliper 7"

Curved

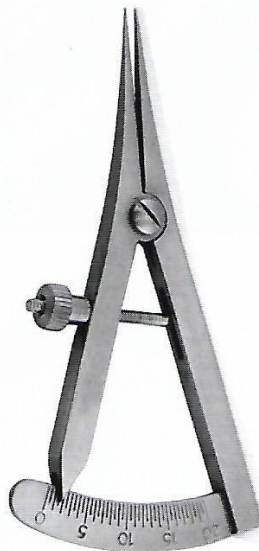

CASTROVIEJO, Left

F1-083 8 cm, 3", Str.

Eye View Caliper

Measuring range, 20 mm

F1-084 8 cm, 3", Cvd.

Measuring range, 20 mm



CASTROVIEJO, Right

F1-085

8 cm, 3"

Eye View Caliper

Measuring range

20 mm



TROCARS, SUCTION TUBES & CANNULAS



TROCARS



Trokare | Trócares
Trocart | Trequarti

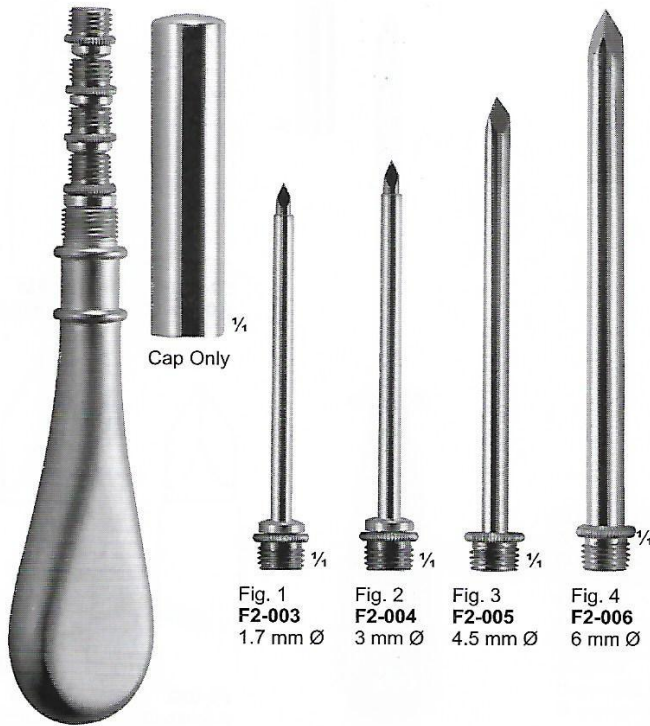

UNIVERSAL Abdominal Trocar Set
F2-001
(Handle with 4 needles) 14 cm, 5 1/2"
Fig. 1.7 mm Ø to 6 mm Ø
F2-002
Only Handle

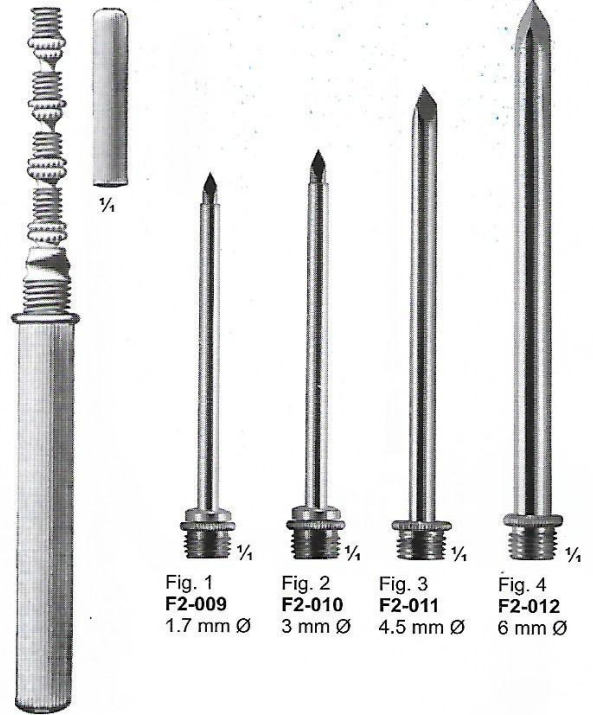

UNIVERSAL Abdominal Trocar Set
F2-007
(Handle with 4 needles) 14 cm, 5 1/2"
Fig. 1.7 mm Ø to 6 mm Ø
F2-008
Only Handle



LUER, Trocar
F2-013
Luer Lock Adapter



UCKERMANN, Trocar
F2-014
13.0 cm 5"



SINUSCOPY, Trocar
17.0 cm 6 3/4"



3.5 mm Ø
F2-015



5.0 mm Ø
F2-016



5.0 mm Ø
F2-017



TROCARS

Trokare | Trocares
Trocarts | Trequarti



LICHTWITZ
Antrum Trocar
19 cm, 7 1/2"

Complete
F2-018 1.8 mm Ø
F2-019 2.0 mm Ø



OCHSNER
Trocar Thorax
10.0 cm 4"

F2-020 3 1/3 mm Ø
F2-021 4 mm Ø
F2-022 4 2/3 mm Ø
F2-023 5 1/3 mm Ø
F2-024 6 mm Ø
F2-025 6 2/3 mm Ø
F2-026 7 1/3 mm Ø
F2-027 8 mm Ø
F2-028 8 2/3 mm Ø
F2-029 9 1/3 mm Ø



NELSON
Trocar Thorax
21.0 cm 8 1/4"

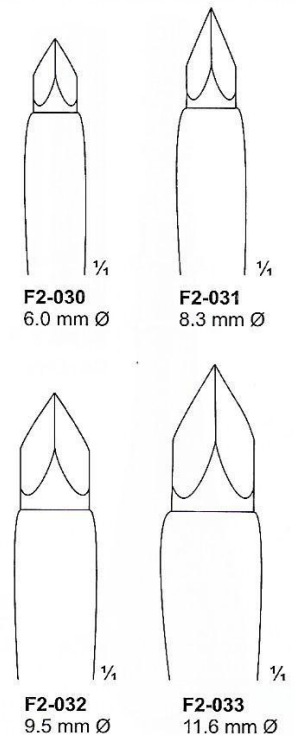

F2-030
6.0 mm Ø

F2-031
8.3 mm Ø

F2-032
9.5 mm Ø

F2-033
11.6 mm Ø



LANDAU, Trocar
F2-034 2.0 mm Ø
16 cm 6 1/4"



PIERCE
Antrum Trocar
17.0 cm 6 3/4"

F2-035 3.0 mm Ø
F2-036 4.0 mm Ø
F2-037 5.0 mm Ø

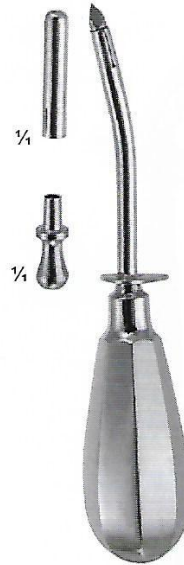

KRAUSE, Trocar
F2-038 15.0 cm 6"
5.5 mm Ø



COAKLEY, Trocar
F2-039 16.0 cm 6 1/4"
2.25 mm Ø

SUCTION TUBES



Saugrohre

Tubos de aspiración

Canules d'aspiration

Tubi per aspirazione



ADSON
Suction Tubes
F2-040
4 mm Ø
15 cm, 6"



ADSON
Suction Tubes
21.0 cm 8 1/4"
F2-041 4 mm Ø 12 Charr./Fr
F2-042 5 mm Ø 15 Charr./Fr



PLESTER
Suction Tubes
17.0 cm 6 3/4"



FERGUSON
Suction Tubes
17.0 cm 6 3/4"

- F2-043** 2 mm Ø 6 Charr./Fr.
- F2-044** 2 1/3 mm Ø 7 Charr./Fr.
- F2-045** 2 2/3 mm Ø 8 Charr./Fr.
- F2-046** 3 mm Ø 9 Charr./Fr.
- F2-047** 3 1/3 mm Ø 10 Charr./Fr.
- F2-048** 3 2/3 mm Ø 11 Charr./Fr.
- F2-049** 4 mm Ø 12 Charr./Fr.
- F2-050** 5 mm Ø 15 Charr./Fr.

- F2-051** 2 mm Ø 6 Charr./Fr.
- F2-052** 2 1/3 mm Ø 7 Charr./Fr.
- F2-053** 2 2/3 mm Ø 8 Charr./Fr.
- F2-054** 3 mm Ø 9 Charr./Fr.
- F2-055** 3 1/3 mm Ø 10 Charr./Fr.
- F2-056** 3 2/3 mm Ø 11 Charr./Fr.
- F2-057** 4 mm Ø 12 Charr./Fr.
- F2-058** 5 mm Ø 15 Charr./Fr.

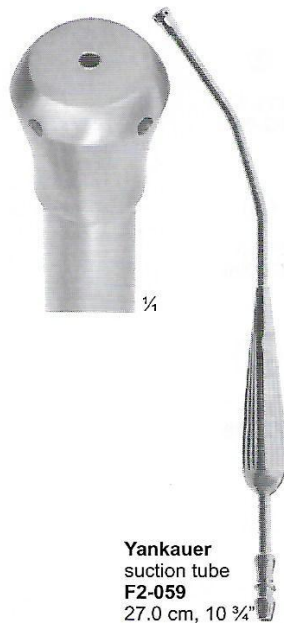

Yankauer
suction tube
F2-059
27.0 cm, 10 3/4"



FRAZIER
Suction Tubes
F2-060 6 Fr.
F2-061 7 Fr.
F2-062 9 Fr.
F2-063 11 Fr.
19 cm, 7 1/2"



FRAZIER 30°
Suction Tubes
F2-064 6 Fr.
F2-065 7 Fr.
F2-066 8 Fr.
F2-067 9 Fr.
F2-068 10 Fr.
F2-069 11 Fr.
F2-070 12 Fr.
F2-071 15 Fr.
18 cm, 7"



FRAZIER 45°
Suction Tubes
F2-072 6 Fr.
F2-073 7 Fr.
F2-074 8 Fr.
F2-075 9 Fr.
F2-076 10 Fr.
F2-077 11 Fr.
F2-078 12 Fr.
18 cm, 7"



EUSTACHIAN CATHETERS

Ohrkatheter

Sondas auriculares

Sondes auriculaires

Sonde auricolari



HARTMANN,
Eustachian Catheters
Fig. 1
F2-079 2.0 mm Ø
F2-080 2.5 mm Ø
F2-081 3.0 mm Ø



HARTMANN
Eustachian Catheters
Fig. 2
F2-082 2.0 mm Ø
F2-083 2.5 mm Ø
F2-084 3.0 mm Ø



KILLIAN, Eustachian Catheters
F2-085 16.0 cm 6" 2.5 mm Ø
F2-086 16.0 cm 6" 3.0 mm Ø
oval opening



HARTMANN
Eustachian Catheters
15.0 cm 6"



Fig. 0
F2-087



Fig. 2
F2-089



Fig. 4
F2-091



Fig. 1
F2-088



Fig. 3
F2-090



Fig. 5
F2-092



TRÖLTSCHE
Eustachian Catheters
15.0 cm 6"



F2-093
Tube end piece
for eustachian
catheter



Fig. 2
F2-095



Fig. 4
F2-097



Fig. 1
F2-094



Fig. 3
F2-096



Fig. 5
F2-098

SUCTION TUBES, GUIDE NEEDLE



Saugrohre, Redon Führungsnadeln

Tubos para aspiración, Agujas de guía

Tubes d'aspiration, Aiguilles d'introduction

Cannule d'aspirazione, Aghi guida



ZÖLLNER, Suction Tube
F2-099 0.7 mm Ø
 complete with 1 slip-on
 cannula, 0.7 mm Ø



IOWA, Suction Tube
F2-100 0.7 mm Ø
 16.0 cm 6 1/4"



MAGILL, Suction Tube
 24.5 cm 9 3/4"
F2-101 3.0 mm Ø
F2-102 3.5 mm Ø
F2-103 4.0 mm Ø



ROSEN, Suction Tube
 X=80 mm
F2-104 0.7 mm Ø
F2-105 0.9 mm Ø
F2-106 1.2 mm Ø



ROSEN, Suction Tube
 X=65 mm
F2-107 0.7 mm Ø
F2-108 0.9 mm Ø
F2-109 1.2 mm Ø

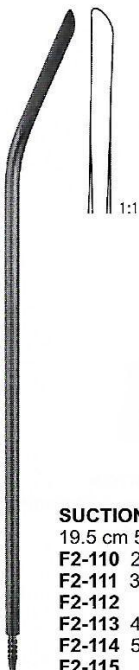

SUCTION TUBE, Guide Needle
 19.5 cm 5 3/4"
F2-110 2.2/3 mm Ø 8 Charr./Fr.
F2-111 3.1/3 mm Ø 10 Charr./Fr.
F2-112 4 mm Ø 12 Charr./Fr.
F2-113 4 2/3 mm Ø 14 Charr./Fr.
F2-114 5 1/3 mm Ø 16 Charr./Fr.
F2-115 6 mm Ø 18 Charr./Fr.

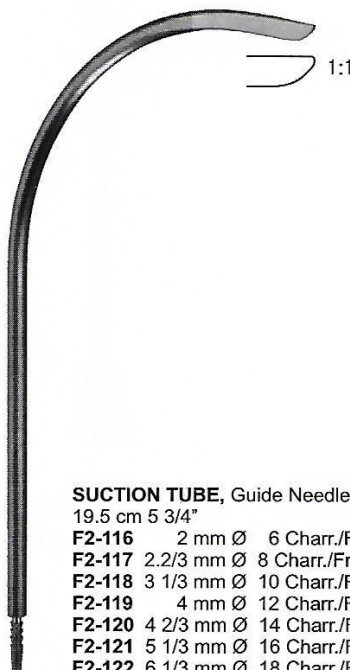

SUCTION TUBE, Guide Needle
 19.5 cm 5 3/4"
F2-116 2 mm Ø 6 Charr./Fr.
F2-117 2.2/3 mm Ø 8 Charr./Fr.
F2-118 3 1/3 mm Ø 10 Charr./Fr.
F2-119 4 mm Ø 12 Charr./Fr.
F2-120 4 2/3 mm Ø 14 Charr./Fr.
F2-121 5 1/3 mm Ø 16 Charr./Fr.
F2-122 6 1/3 mm Ø 18 Charr./Fr.







SUCTION TUBE, Guide Needle
Lancet Tip 19.5 cm 5 3/4"
F2-123 2.2/3 mm Ø 8 Charr./Fr.
F2-124 3.1/3 mm Ø 10 Charr./Fr.
F2-125 4 mm Ø 12 Charr./Fr.
F2-126 4 2/3 mm Ø 14 Charr./Fr.
F2-127 5 1/3 mm Ø 16 Charr./Fr.
F2-128 6 mm Ø 18 Charr./Fr.



PROBES AND DIRECTORS

Sonden	Sondas y estiletes
Sondes et stylets	Specilli e sonde

		
PROBE, Double Ended 2.0 mm Ø	PROBE, Double Ended 1.5 mm Ø	PROBE, Double Ended 1.0 mm Ø
F2-129 11.5 cm 4 1/2"	F2-136 11.5 cm 4 1/2"	F2-143 11.5 cm 4 1/2"
F2-130 13.0 cm 5"	F2-137 13.0 cm 5"	F2-144 13.0 cm 5"
F2-131 14.5 cm 5 3/4"	F2-138 14.5 cm 5 3/4"	F2-145 14.5 cm 5 3/4"
F2-132 16.0 cm 6 1/4"	F2-139 16.0 cm 6 1/4"	F2-146 16.0 cm 6 1/4"
F2-133 18.0 cm 7"	F2-140 18.0 cm 7"	F2-147 18.0 cm 7"
F2-134 20.0 cm 8"	F2-141 20.0 cm 8"	F2-148 20.0 cm 8"
F2-135 25.0 cm 9 3/4"	F2-142 25.0 cm 9 3/4"	F2-149 25.0 cm 9 3/4"

	
PROBE With Eye 2.0 mm Ø	PROBE 2.0 mm Ø
F2-150 11.5 cm 4 1/2"	F2-157 11.5 cm 4 1/2"
F2-151 13.0 cm 5"	F2-158 13.0 cm 5"
F2-152 14.5 cm 5 3/4"	F2-159 14.5 cm 5 3/4"
F2-153 16.0 cm 6 1/4"	F2-160 16.0 cm 6 1/4"
F2-154 18.0 cm 7"	myrtle-shaped
F2-155 20.0 cm 8"	
F2-156 25.0 cm 9 3/4"	
with eyelet	



BUTTERFLY GROOVED
Director With Tongue Tie
Plain End

F2-161 11.5 cm 4 1/2"
F2-162 13.0 cm 5"
F2-163 14.5 cm 5 3/4"
F2-164 16.0 cm 6 1/4"
F2-165 18.0 cm 7"
F2-166 20.0 cm 8"



BUTTERFLY GROOVED
Director With Tongue Tie
Plain End

F2-167 11.5 cm 4 1/2"
F2-168 13.0 cm 5"
F2-169 14.5 cm 5 3/4"
F2-170 16.0 cm 6 1/4"
F2-171 18.0 cm 7"
F2-172 20.0 cm 8"



DOYEN
Probes & Directors
F2-173
14.0 cm 5 1/2"



NÉLATON
Probes & Directors
F2-174
16.0 cm 6 1/2"

COTTON APPLICATORS



Watteträger | Porta-algodones
 Porte-cotons | Portacotoni



JOPSON-HORNE
 cotton applicator
F2-175
 18.0 cm 7"

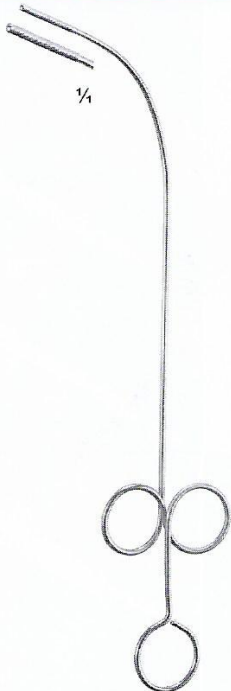

FEIN
 cotton applicator
F2-176
 28.0 cm 11"



PELTESON
 cotton applicator
F2-177
 23.0 cm 9"



BARR Fistula Probe
F2-178
 with 8" (20.3 cm) sterling shaft,
 eye at tip, 11-1/2" (29.2 cm) overall



BARR Crypt Hook,
F2-179
 10" (25.4 cm), short and
 long hook ends



BUIE Suction Tube,
F2-180
 18" (45 cm), with finger
 valve, 15 Fr. (5 mm)



Biolvar
F2-181 15cm
F2-182 18cm
F2-183 20cm



Desjardim
F2-184 18cm
 (Set 3 Pieces)



SCALPEL HANDLE, SCALPEL BLADES, DISSECTING KNIVES & SAWS

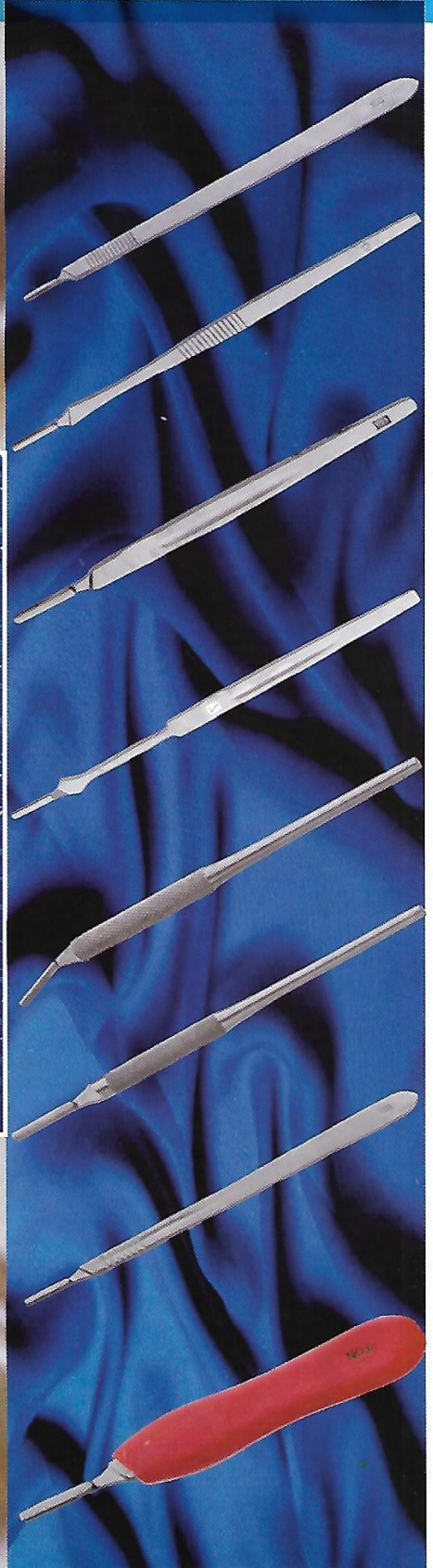
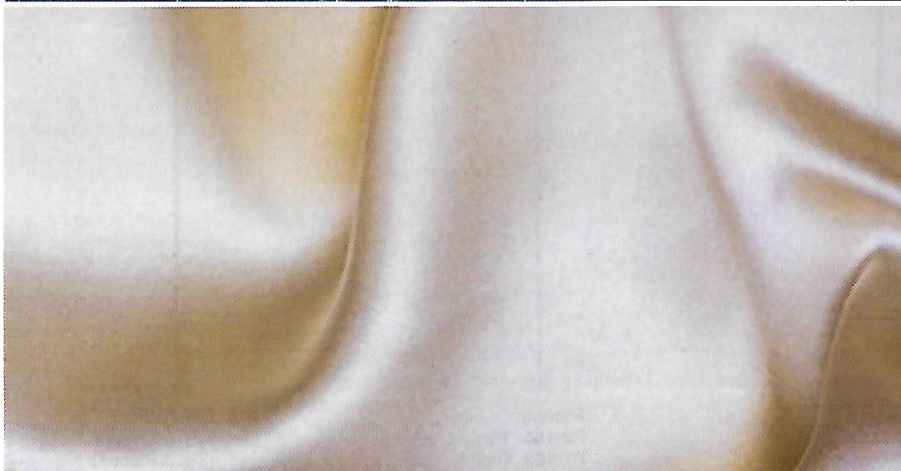

SCALPEL HANDLES



Skalpelligriffe
Mangos de bisturias

Manches pour bistouris
Manici per bisturi

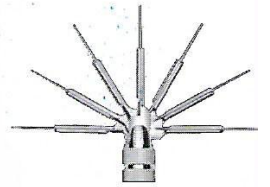

Locks At 90°, 60°, 30°,
Straight, 120°, 150°, 180°,
Angles



SCALPEL HANDLE #3
F3-001
12.75 cm, 5"
Blade Size 10, 11,
12, 13, 15, 17



**#3 SCALPEL HANDLE/
GRADUATED**
F3-002
12.75 cm, 5"
Blade Size 10, 11,
12, 13, 15, 17



**SCALPEL HANDLE
#4 GRADUATED**
F3-003
with scale



SCALPEL HANDLE #4
F3-004
12.75 cm, 5" Blade
Size 18, 20, 21, 22,
23, 24, 25, 60,70



SCALPEL HANDLE 4LA
F3-005
21 cm, 8 1/4" Blade
Size 18, 20, 21, 22,
23, 24, 25, 60,70



**SIEGEL ROUND
SCALPEL HANDLE
#3**
F3-006
With Adjustable
Tip 16 cm, 6 1/4"
Blade Size 10,
11, 12, 13, 15,
17



SCALPEL HANDLES

Skalpelli
Mangos de bisturios

Manches pour bistouris
Manici per bisturi



**SCALPEL HANDLE #3, #4
F3-007**
Double Ended
16 cm, 6"

**SCALPEL HANDLE
3L LONG
F3-008** 21 cm 8 1/4"
Blade Size
10, 11, 12, 15, 17

**SCALPEL HANDLE #7
F3-009**
16.5 cm, 6 1/4"
Blade 10, 11,
12, 13, 15, 17

**SCALPEL HANDLE
4L LONG
F3-010** 21 cm, 8 1/4"
Blade
Size 18, 20, 21,
22, 23, 24, 25,
60,70

**SCALPEL HANDLE
/ LONG ANGLED #3LA
F3-011**
20.25 cm, 8 1/4"
Blade Size
10, 11, 12, 15, 17

**KNIFE HANDLE
F3-012**
(Smooth) for
Blades Nos.
60 and 70

**ROUND KNURLED
SCALPEL HANDLE
F3-013**
12.7 cm, 5"
Blade Size
50, 60 & 70

SCALPEL HANDLES



Skalpgriffe
Mangos de bisturíes

Manches pour bistouris
Manici per bisturi



**ROUND KNURLED
SCALPEL HANDLE**
F3-014
12 cm, 4 3/4"



**KAYE ROUND
SCALPEL HANDLE**
#3RK
F3-015
15 cm, 5 3/4", Blade
Size 10, 11,
12, 13, 15, 17



**CORWIN ROUND
SCALPEL HANDLE**
#3R
F3-016
14.5 cm, 5 1/2"
Blade Size 10,
11, 12, 15, 17



SCALPEL HANDLE
#3RC
F3-017
14 cm, 5 1/2"
Blade Size 10,
11, 12, 13, 15,
17



**CORWIN ROUND
SCALPEL HANDLE,**
#4R
F3-018
14.5 cm, 5 1/2",
Blade Size 18, 20,
21, 22, 23, 24,
25, 60, 70



SCALPEL HANDLE
#3P
F3-019
15.5 cm,
6", Blade Size
10, 11, 12, 13,
15, 17



SCALPEL BLADES

Skalpellskliven,
Lames de bistouris, Mangos

Hojas de bisturi, Manches
Lame per bisturi, Manici



F3-020
Sterile Scalpel
Blade Size # 6
Stainless Steel



F3-021
Sterile Scalpel
Blade Size # 10
Stainless Steel



F3-022
Sterile Scalpel
Blade Size # 10A
Stainless Steel



F3-023
Sterile Scalpel
Blade Size # 11
Stainless Steel



F3-024
Sterile Scalpel
Blade Size # 11P
Stainless Steel



F3-025
Sterile Scalpel
Blade Size # E11
Stainless Steel

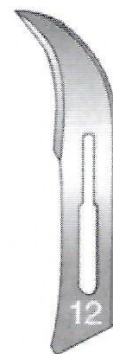

F3-026
Sterile Scalpel
Blade Size # 12
Stainless Steel



F3-027
Sterile Scalpel
Blade Size # 13
Stainless Steel



F3-028
Sterile Scalpel
Blade Size # 15
Stainless Steel



F3-029
Sterile Scalpel
Blade Size # 15A
Stainless Steel



F3-030
Sterile Scalpel
Blade Size # 17
Stainless Steel



F3-031
Sterile Scalpel
Blade Size # 18
Stainless Steel



F3-032
Sterile Scalpel
Blade Size # 20
Stainless Steel



F3-033
Sterile Scalpel
Blade Size # 21
Stainless Steel



F3-034
Sterile Scalpel
Blade Size # 22
Stainless Steel



F3-035
Sterile Scalpel
Blade Size # 23
Stainless Steel



F3-036
Sterile Scalpel
Blade Size # 24
Stainless Steel



F3-037
Sterile Scalpel
Blade Size # 25
Stainless Steel



F3-038
Sterile Scalpel
Blade Size # 36
Stainless Steel



F3-039
Sterile Scalpel
Blade Size # 40
Stainless Steel



F3-040
Sterile Scalpel
Blade Size # 60
Stainless Steel



F3-041
Sterile Scalpel
Blade Size # 70
Stainless Steel

SCALPEL HANDLES



Skalpgriffe
Mangos de bisturios

Manches pour bistouris
Manici per bisturi



DIEFFENBACH
16 cm, 6 1/4"



F3-042
Fig. 1
16 cm, 6 1/4"



F3-043
Fig. 2
16 cm, 6 1/4"



F3-044
Fig. 3
16 cm, 6 1/4"



F3-045
Fig. 4
16 cm, 6 1/4"



F3-046
Fig. 5
16 cm, 6 1/4"



F3-047
Fig. 6
16 cm, 6 1/4"



F3-048
Fig. 7
16 cm, 6 1/4"



F3-049
Fig. 8
16 cm, 6 1/4"



F3-050
Fig. 9
16 cm, 6 1/4"



F3-051
Fig. 10
16 cm, 6 1/4"



F3-052
Fig. 15
16 cm, 6 1/4"



F3-053
Fig. 16
16 cm, 6 1/4"



DISSECTING KNIVES

Anatomische skalpelle
Bisturías para disección

Bistouris à dissection
Bisturi para dissezione

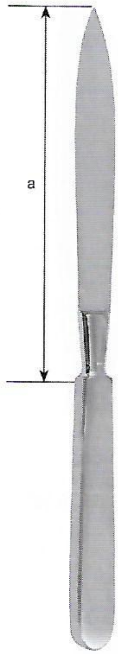

COLLIN DISSECTING KNIVES Blade Size
F3-054 13 cm, 5"
F3-055 16 cm, 6 ¼"
F3-056 19 cm, 7 ½"
F3-057 22 cm, 8 ½"
F3-058 28 cm, 11 ¼"



CATLIN DISSECTING KNIVES Blade Size
F3-059 16 cm, 6 ¼"
F3-060 19 cm, 7 ½"
F3-061 22 cm, 8 ½"

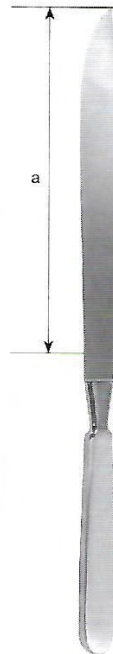

LISTON DISSECTING KNIVES Blade Size
F3-062 16 cm, 6 ¼"
F3-063 19 cm, 7 ½"
F3-064 22 cm, 8 ½"

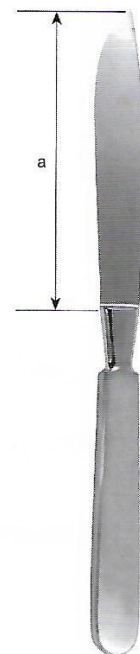

LANGENBECK DISSECTING KNIVES BLADE
F3-065
 12 cm, 4 ¾"



DIEFFENBACH DISSECTING KNIVES
F3-066
 13 cm, 5"



DIEFFENBACH DISSECTING KNIVES
F3-067
 13 cm, 5"



SIMON DISSECTING KNIVES
 23.5 cm, 9 ½"



F3-068
 Fig.1



F3-069
 Fig. 2



F3-070
 Fig. 3



F3-071
 Fig. 4

AMPUTATION KNIVES & RESECTION SAWS



Amputationsmesser, Cuchillos para amputación
Couteaux à amputation, coltelli per amputazione

Resektionsmesser, Cuchillos para resección
Couteaux à résection, Coltelli per resezione



AMPUTATION KNIFE
F3-072
29 cm, 11 1/2"



AMPUTATION KNIFE
F3-073
32.5 cm, 13"



CATLIN AMPUTATION
F3-074
29 cm, 11 1/2"



RESECTION KNIFE
F3-075
18 cm, 7"



LANGENBECK AMPUTATION
F3-076
18 cm, 7"



LANGENBECK AMPUTATION
F3-077
18 cm, 7"



RAZOR HOLLOW
Blades On
Both Sides
Blade Flat / Hollow
F3-078

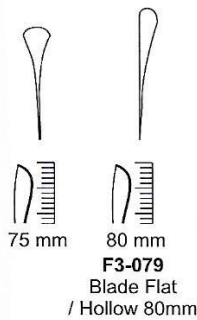

CHARRIERE AMPUTATION & RESECTION
F3-080 27 cm, 11"
F3-081 30 cm, 12"

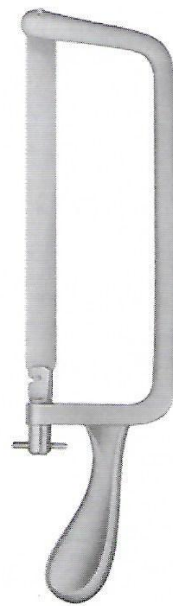

CHARRIERE AMPUTATION & RESECTION
F3-082
35 cm, 13 3/4"



SATTERLEE AMPUTATION & RESECTION
F3-083
31 cm, 12 1/4"



DERMATOMES

Dermatome
Dermatomes

Dermatomos
Dermatomi

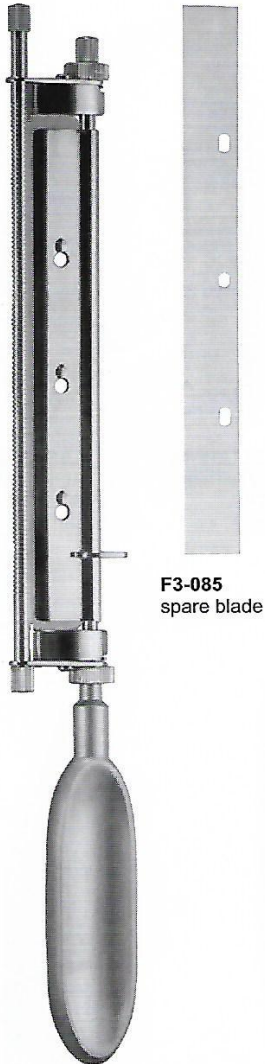

F3-085
spare blade

HUMBY DERMATOMES
F3-084 31cm 12 1/4"
Complete with 1 Blade



WATSON DERMATOMES
F3-086 30cm 12"
Complete with 1 Blade,
fixed bar



SILVER DERMATOMES
F3-087 19cm 7 1/2"



GENERAL OPERATING SCISSORS

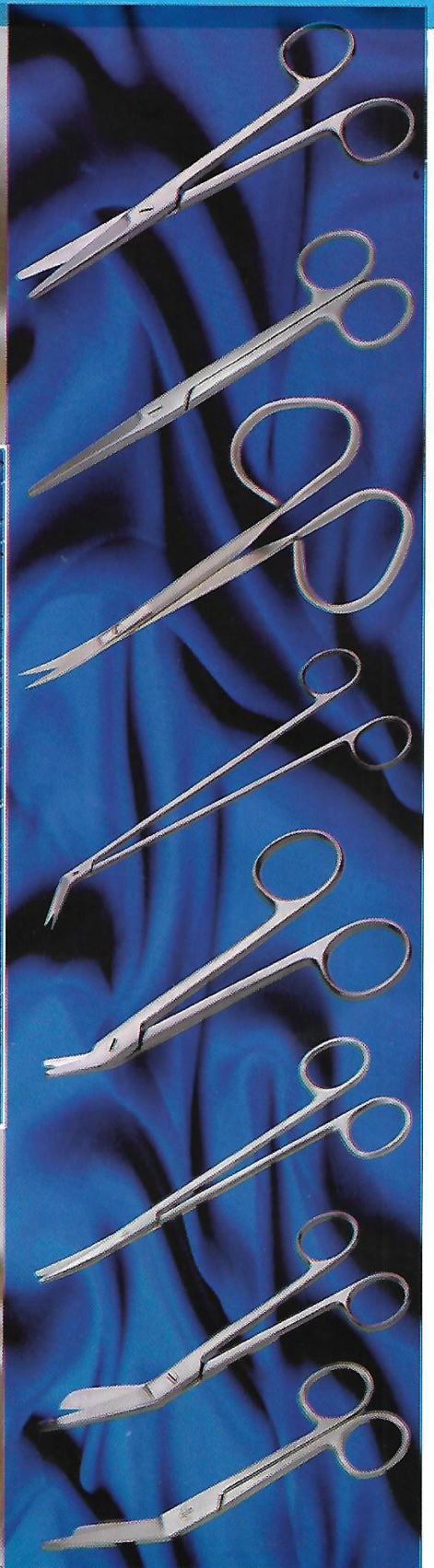
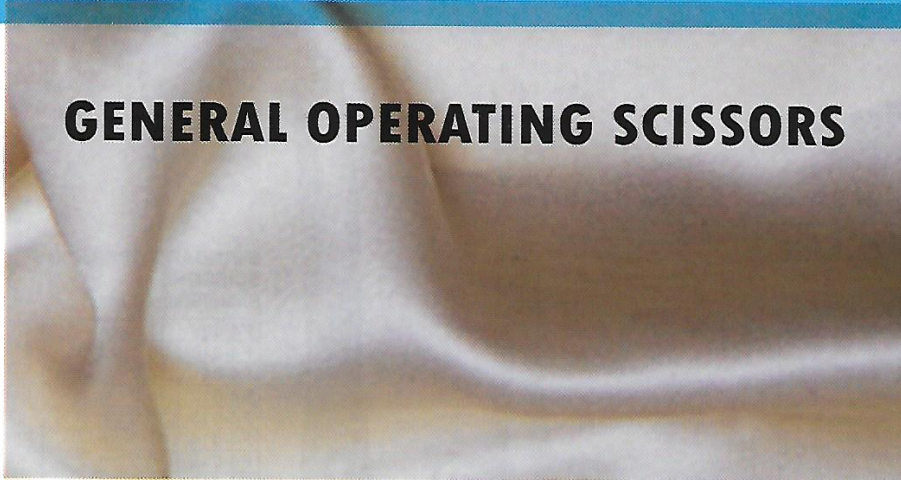



OPERATING SCISSORS

Chirurgische scheren
Tijeras Para Cirugia

Ciseaux à chirurgie
Forbici per chirurgia

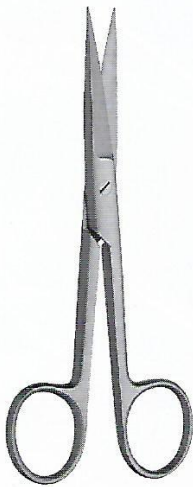

STANDARD OPERATING SCISSORS

Sharp/Sharp Straight

F4-001	11.5 cm, 4 1/2"
F4-002	13.0 cm, 5"
F4-003	14.0 cm, 5 1/2"
F4-004	15.0 cm, 6"
F4-005	16.0 cm, 6 1/4"
F4-006	17.5 cm, 7"
F4-007	18.5 cm, 7 1/4"
F4-008	20.0 cm, 8"

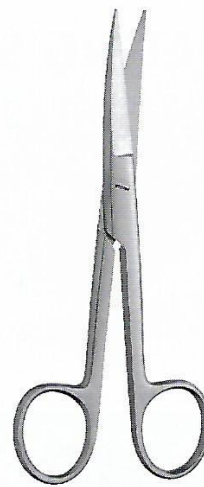

STANDARD OPERATING SCISSORS

Sharp/Sharp Curved

F4-009	11.5 cm, 4 1/2"
F4-010	13.0 cm, 5"
F4-011	14.0 cm, 5 1/2"
F4-012	15.0 cm, 6"
F4-013	16.0 cm, 6 1/4"
F4-014	17.5 cm, 7"
F4-015	18.5 cm, 7 1/4"
F4-016	20.0 cm, 8"

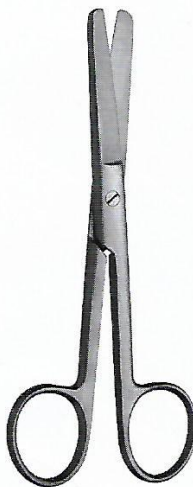

STANDARD OPERATING SCISSORS

Blunt/Blunt Straight

F4-017	11.5 cm, 4 1/2"
F4-018	13.0 cm, 5"
F4-019	14.0 cm, 5 1/2"
F4-020	15.0 cm, 6"
F4-021	16.0 cm, 6 1/4"
F4-022	17.5 cm, 7"
F4-023	18.5 cm, 7 1/4"
F4-024	20.0 cm, 8"

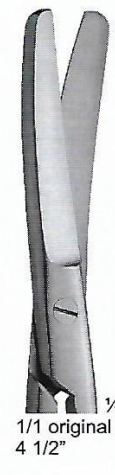
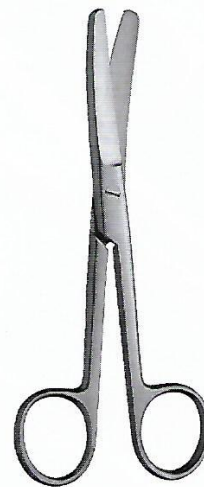

STANDARD OPERATING SCISSORS

Blunt/Blunt Curved

F4-025	11.5 cm, 4 1/2"
F4-026	13.0 cm, 5"
F4-027	14.0 cm, 5 1/2"
F4-028	15.0 cm, 6"
F4-029	16.0 cm, 6 1/4"
F4-030	17.5 cm, 7"
F4-031	18.5 cm, 7 1/4"
F4-032	20.0 cm, 8"

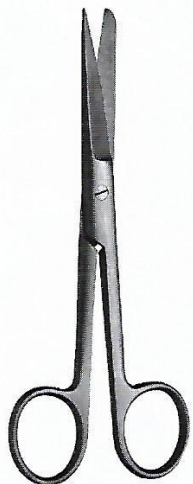

STANDARD OPERATING SCISSORS

Sharp/Blunt Straight

F4-033	11.5 cm, 4 1/2"
F4-034	13.0 cm, 5"
F4-035	14.0 cm, 5 1/2"
F4-036	15.0 cm, 6"
F4-037	16.0 cm, 6 1/4"
F4-038	17.5 cm, 7"
F4-039	18.5 cm, 7 1/4"
F4-040	20.0 cm, 8"

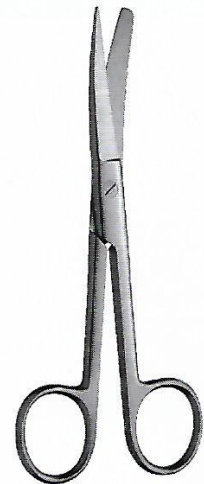

STANDARD OPERATING SCISSORS

Sharp/Blunt Curved

F4-041	11.5 cm, 4 1/2"
F4-042	13.0 cm, 5"
F4-043	14.0 cm, 5 1/2"
F4-044	15.0 cm, 6"
F4-045	16.0 cm, 6 1/4"
F4-046	17.5 cm, 7"
F4-047	18.5 cm, 7 1/4"
F4-048	20.0 cm, 8"

OPERATING & DISSECTING SCISSORS



Bedienen & Präparierscheren
Funcionamiento y disección Tijeras

D'exploitation & Ciseaux de dissection
Forbici di funzionamento e di dissezione



**LANDOLT OPERATING
SCISSORS**

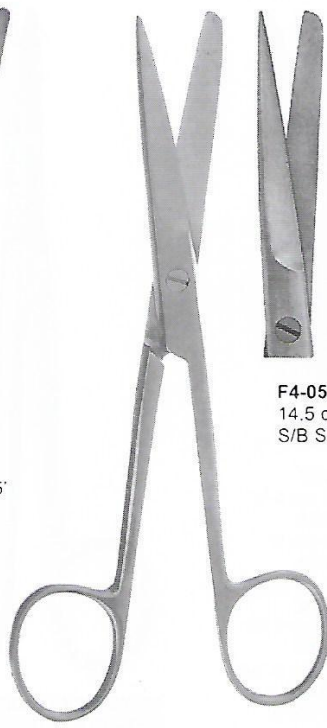

**DEAVER OPERATING,
DISSECTING SCISSORS**

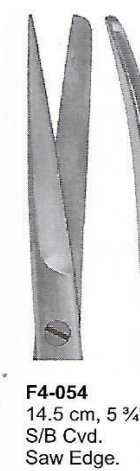
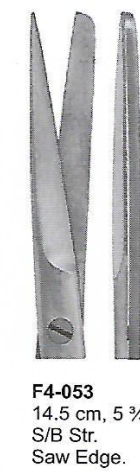
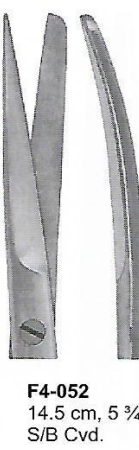
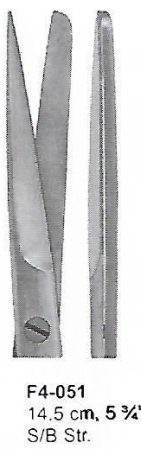

**LONGE OPERATING,
DISSECTING SCISSORS**

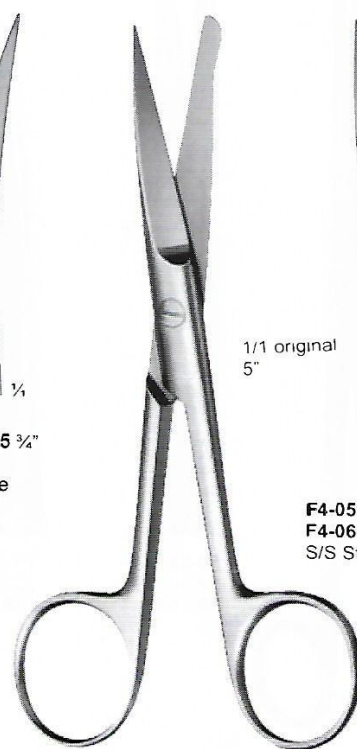

INCISION OPERATING SCISSORS

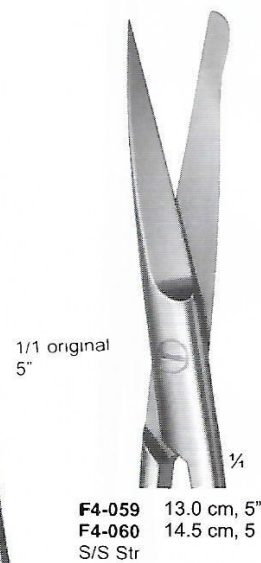



DISSECTING & GYNECOLOGICAL SCISSORS

Präparierscheren & Gynäkologische Scheren
Dissección y tijeras ginecológicas

Dissection et Ciseaux gynécologiques
Dissezione & Forbici Ginecologiche



MAYO DISSECTING & GYNECOLOGICAL SCISSORS



1/1 original
5 3/4"

- F4-061**
14.5 cm 5 3/4"
- F4-062**
15.0 cm 6"
- F4-063**
17.0 cm 6 3/4"
- F4-064**
19.5 cm 7 3/4"
- F4-065**
21.0 cm 8 1/4"
- F4-066**
23.0 cm 9"



- F4-067**
14.5 cm 5 3/4"
- F4-068**
15.0 cm 6"
- F4-069**
17.0 cm 6 3/4"
- F4-070**
19.5 cm 7 3/4"
- F4-071**
21.0 cm 8 1/4"
- F4-072**
23.0 cm 9"

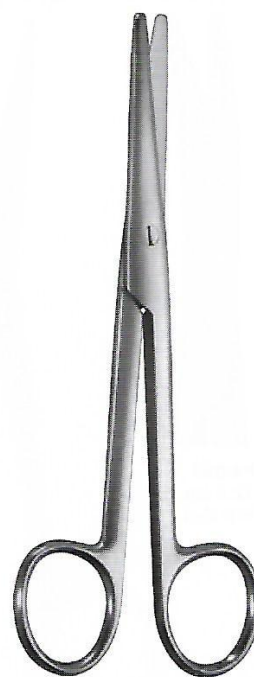

MAYO-STILLE DISSECTING & GYNECOLOGICAL SCISSORS



1/1 original
6"

- F4-073**
15.0 cm 6"
- F4-074**
17.0 cm 6 3/4"
- F4-075**
19.5 cm 7 3/4"
- F4-076**
21.0 cm 8 3/4"



- F4-077**
15.0 cm 6"
- F4-078**
17.0 cm 6 3/4"
- F4-079**
19.5 cm 7 3/4"
- F4-080**
21.0 cm 8 3/4"

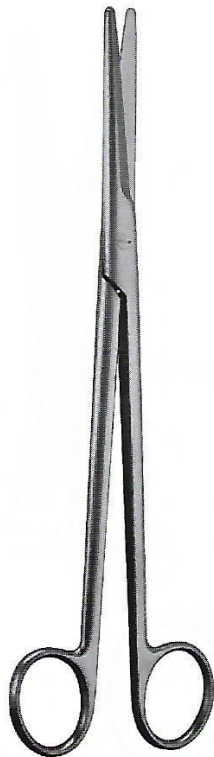

MAYO-HARRINGTON DISSECTING & GYNECOLOGICAL SCISSORS



- F4-081**
22.5 cm 9"



- F4-082**
22.5 cm 9"

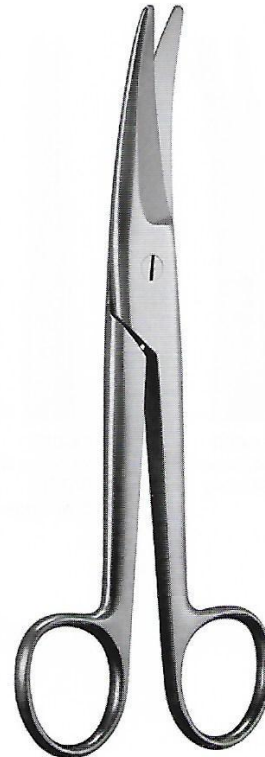

MAYO-NOBLE DISSECTING & GYNECOLOGICAL SCISSORS



- F4-083**
17.0 cm, 6 3/4"



- F4-084**
17.0 cm, 6 3/4"

OPERATING & DISSECTING SCISSORS



Bedienen & Präparierscheren
Funcionamiento y disección Tijeras

D'exploitation & Ciseaux de dissection
Forbici di funzionamento e di dissezione

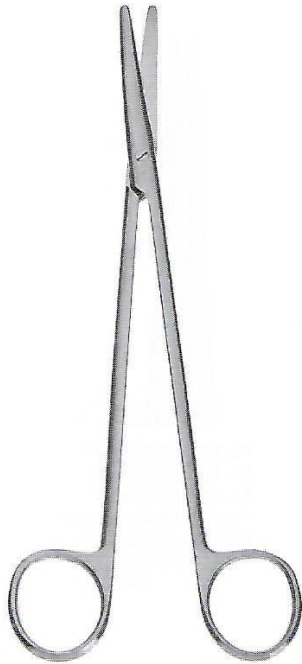

**METZENBAUM OPERATING,
DISSECTING SCISSORS
BLUNT/BLUNT STR.**



F4-085
14.5 cm 5 3/4"
B/B Str.



F4-086
18 cm 7"
B/B Str.



F4-087
20 cm 8"
B/B Str.



F4-088
23 cm 9"
B/B Str.



F4-089
25 cm 10"
B/B Str.

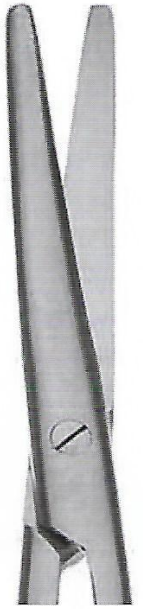

F4-090
28 cm 11"
B/B Str.



**METZENBAUM OPERATING,
DISSECTING SCISSORS
BLUNT/BLUNT CVD.**



F4-091
14.5 cm 5 3/4"
B/B Cvd.



F4-092
18 cm 7"
B/B Cvd.



F4-093
20 cm 8"
B/B Cvd.



F4-094
23 cm 9"
B/B Cvd.



F4-095
25 cm 10"
B/B Cvd.



F4-096
28 cm 11"
B/B Cvd.



OPERATING & DISSECTING SCISSORS

Bedienen & Präparierscheren

D'exploitation & Ciseaux de dissection

Funcionamiento y disección Tijeras

Forbici di funzionamento e di dissezione

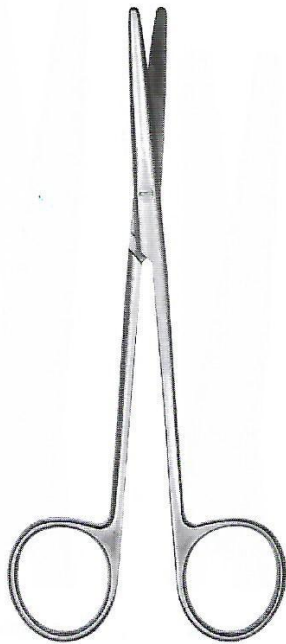

**METZENBAUM-NELSON
SCISSORS**



1/1 original
7"

- F4-097 18.0 cm 7"
- F4-098 20.0 cm 8"
- F4-099 23.0 cm 9"
- F4-100 25.0 cm 9 3/4"
- F4-101 28.0 cm 11"
- F4-102 30.0 cm 12"
B/B Str.



1/1 original
7"

- F4-103 18.0 cm 7"
- F4-104 20.0 cm 8"
- F4-105 23.0 cm 9"
- F4-106 25.0 cm 9 3/4"
- F4-107 28.0 cm 11"
- F4-108 30.0 cm 12"
S/B Str.



- F4-109 18.0 cm 7"
- F4-110 20.0 cm 8"
- F4-111 23.0 cm 9"
- F4-112 25.0 cm 9 3/4"
- F4-113 28.0 cm 11"
- F4-114 30.0 cm 12"
S/S Str.

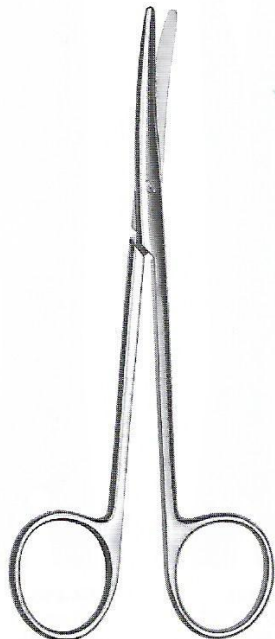

**METZENBAUM-NELSON
SCISSORS**



1/1 original
7"

- F4-115 18.0 cm 7"
- F4-116 20.0 cm 8"
- F4-117 23.0 cm 9"
- F4-118 25.0 cm 9 3/4"
- F4-119 28.0 cm 11"
- F4-120 30.0 cm 12"
B/B Cvd.



1/1 original
7"

- F4-121 18.0 cm 7"
- F4-122 20.0 cm 8"
- F4-123 23.0 cm 9"
- F4-124 25.0 cm 9 3/4"
- F4-125 28.0 cm 11"
- F4-126 30.0 cm 12"
S/B Cvd.



- F4-127 18.0 cm 7"
- F4-128 20.0 cm 8"
- F4-129 23.0 cm 9"
- F4-130 25.0 cm 9 3/4"
- F4-131 28.0 cm 11"
- F4-132 30.0 cm 12"
S/S Cvd.

OPERATING & DISSECTING SCISSORS



Bedienen & Präparierscheren

D'exploitation & Ciseaux de dissection

Funcionamiento y disección Tijeras

Forbici di funzionamento e di dissezione

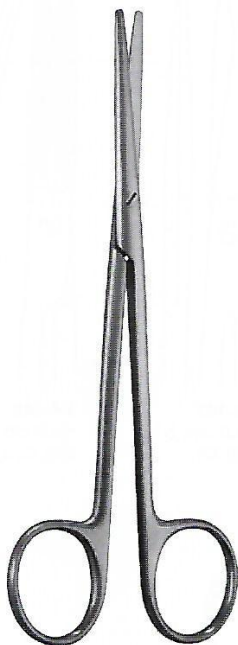

**METZENBAUM-FINO
SCISSORS**



F4-133
14.5 cm 5 3/4"
B/B Str.



F4-134
14.5 cm 5 3/4"
S/S Str.



F4-135
14.5 cm 5 3/4"
B/B Cvd.



F4-136
14.5 cm 5 3/4"
S/S Cvd.



**METZENBAUM-FINO
SCISSORS**



F4-137
18 cm 7"
F4-138
220 cm 8"
F4-139
230 cm 9"
B/B Str.

1/1 original
7"



F4-140
18 cm 7"
F4-141
220 cm 8"
F4-142
230 cm 9"
B/B Cvd.

1/1 original
7"



F4-143
18 cm 7"
F4-144
220 cm 8"
F4-145
230 cm 9"
B/B Slightly
Cvd.



OPERATING & DISSECTING SCISSORS

Bedienen & Präparierscheren
Funcionamiento y disección Tijeras

D'exploitation & Ciseaux de dissection
Forbici di funzionamento e di dissezione

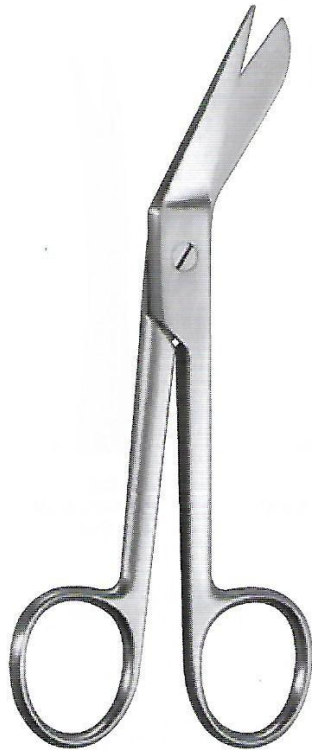

**RICHTER OPERATING,
DISSECTING SCISSORS**
F4-146 14.5 cm, 5 3/4"
Angled

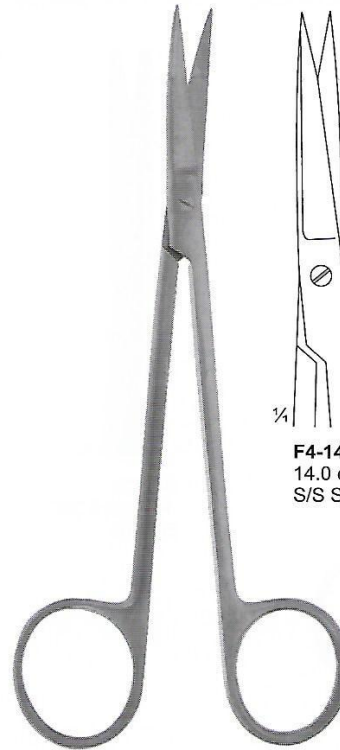

**JOSEPH OPERATING,
DISSECTING SCISSORS**

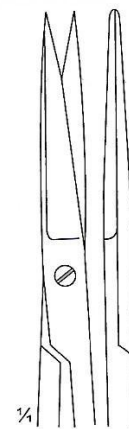

F4-147
14.0 cm, 5 1/2"
S/S Str.

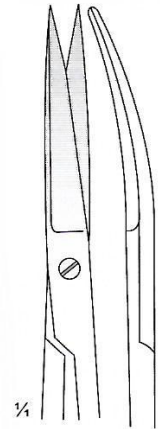

F4-148
14.0 cm, 5 1/2"
S/S Cvd

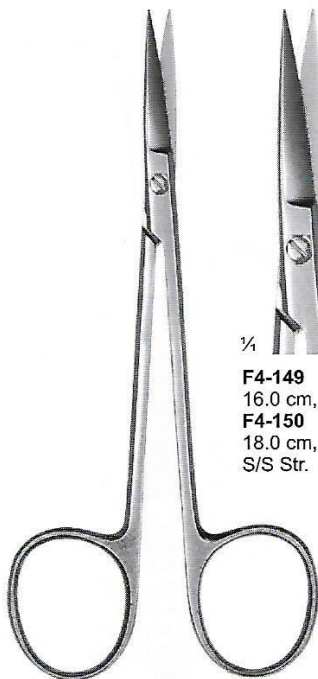

**KELLY OPERATING,
DISSECTING SCISSORS**

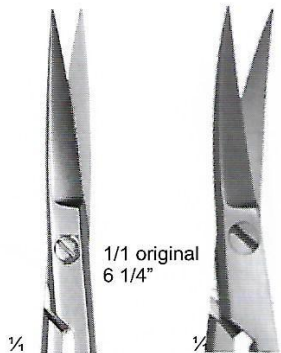

F4-149
16.0 cm, 6 1/4"
F4-150
18.0 cm, 7"
S/S Str.



F4-151
16.0 cm, 6 1/4"
F4-152
18.0 cm, 7"
S/S Cvd.



**DOYEN OPERATING,
DISSECTING SCISSORS**
F4-153 17.5 cm, 7"
B/B, Str.



**DOYEN OPERATING,
DISSECTING SCISSORS**
F4-154 17.5 cm, 7"
B/B, Cvd.

DISSECTING & GYNECOLOGICAL SCISSORS



Präparierscheren & Gynäkologische Scheren
Dissección y tijeras ginecológicas

Dissection et Ciseaux gynécologiques
Dissezione & Forbici Ginecologiche



SIMS DISSECTING & GYNECOLOGICAL SCISSORS

F4-155 20.0 cm, 8"
F4-156 23.0 cm, 9"
Str, B/B

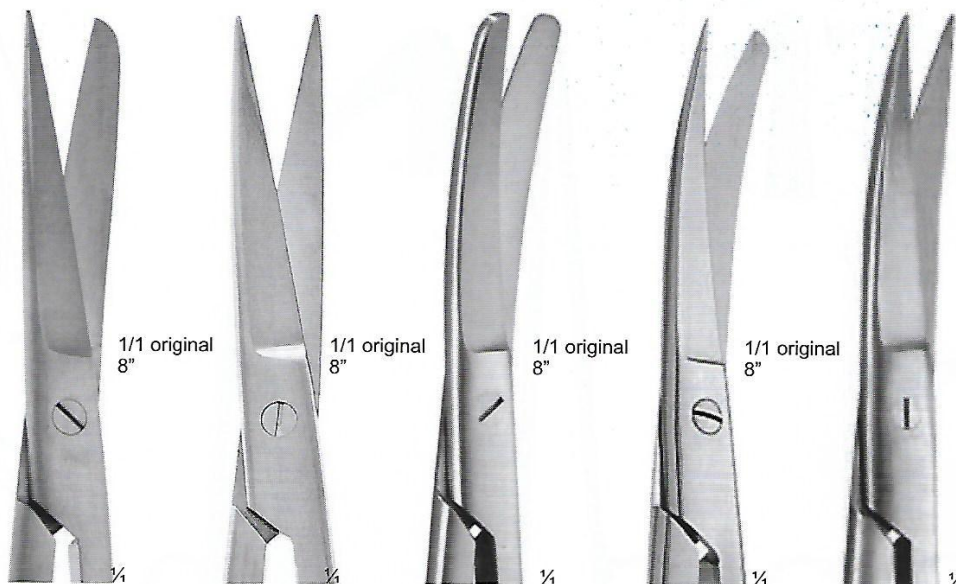

F4-157 20.0 cm, 8" Str, S/B	F4-158 23.0 cm, 9"	F4-159 20.0 cm, 8" Str, S/S	F4-160 23.0 cm, 9"	F4-161 20.0 cm, 8" Cvd, B/B	F4-162 23.0 cm, 9"	F4-163 20.0 cm, 8" Cvd, S/B	F4-164 23.0 cm, 9"	F4-165 20.0 cm, 8" Cvd, S/S	F4-166 23.0 cm, 9"
---------------------------------------	---------------------------	---------------------------------------	---------------------------	---------------------------------------	---------------------------	---------------------------------------	---------------------------	---------------------------------------	---------------------------

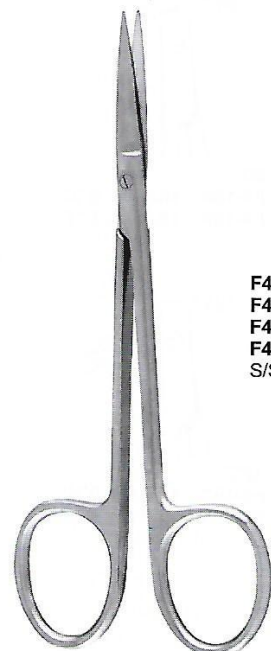

Iris Scissors



F4-167 09 cm, 3 1/2" S/S Str.	F4-168 10.5 cm, 4 1/4"	F4-169 11.5 cm, 4 1/2"	F4-170 12.0 cm, 4 3/4"	F4-171 09 cm, 3 1/2" S/S Cvd.	F4-172 10.5 cm, 4 1/4"	F4-173 11.5 cm, 4 1/2"	F4-174 12.0 cm, 4 3/4"	F4-175 11.5 cm, 4 1/2" Angular Left	F4-176 11.5 cm, 4 1/2" Laterally Cvd.	F4-177 11.5 cm, 4 1/2" Angular Right
-----------------------------------------	-------------------------------	-------------------------------	-------------------------------	-----------------------------------------	-------------------------------	-------------------------------	-------------------------------	-----------------------------------------------	-------------------------------------------------	------------------------------------------------



OPERATING SCISSORS

Chirurgische scheren
Tijeras Para Cirugia

Ciseaux à chirurgie
Forbici per chirurgia

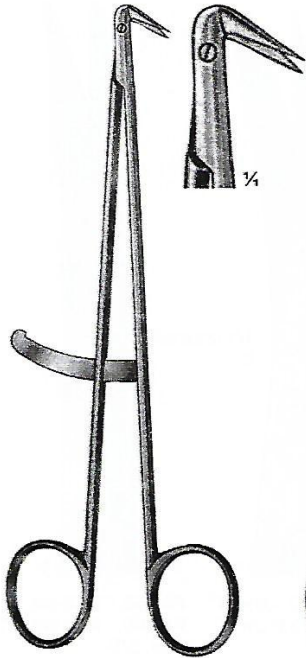

VASCULAR SCISSORS
F4-178 19.0 cm, 7 1/2"
S/S Angled 125°

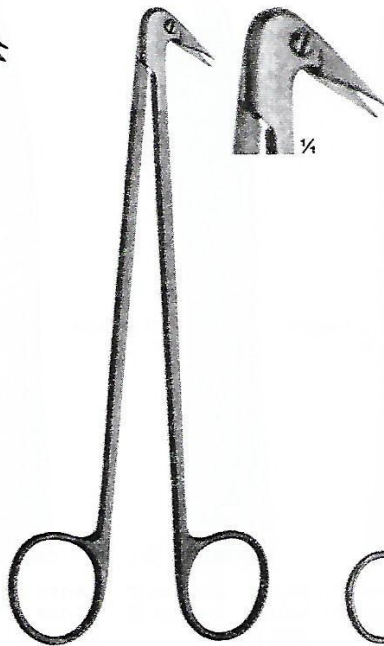

COOLEY REVERSE CUT SCISSORS
F4-179 17.1 cm, 6 3/4"
S/S angled 125°



POTTS-SMITH VASCULAR SCISSORS
S/S Angled

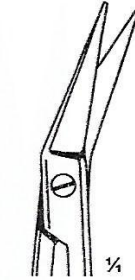

F4-180
19.0 cm, 7 1/2"
25°

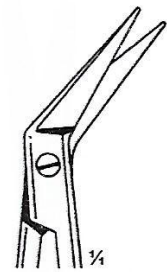

F4-181
19.0 cm, 7 1/2"
45°

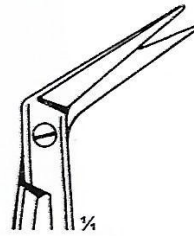

F4-182
19.0 cm, 7 1/2"
60°

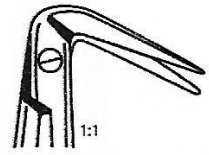

F4-183
19.0 cm, 7 1/2"
125°



HEGEMANN-DIETRICH VASCULAR SCISSORS
S/S Angled

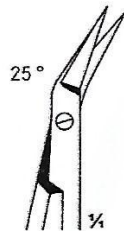

25°
F4-184 16.0 cm, 6 1/4"
F4-185 19.0 cm, 7 1/2"

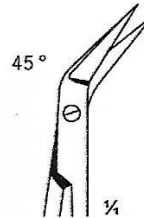

45°
F4-186 16.0 cm, 6 1/4"
F4-187 19.0 cm, 7 1/2"

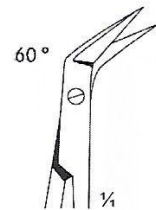

60°
F4-188 16.0 cm, 6 1/4"
F4-189 19.0 cm, 7 1/2"

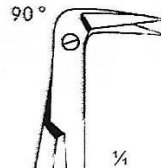

90°
F4-190 16.0 cm, 6 1/4"
F4-191 19.0 cm, 7 1/2"

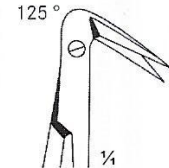

125°
F4-192 16.0 cm, 6 1/4"
F4-193 19.0 cm, 7 1/2"

VASCULAR SCISSORS



Gefäßschere
Tijeras vasculares

Ciseaux vasculaires
Forbici vascolari



DE BAKLEY VASCULAR SCISSORS
S/S Angled



25°
F4-194 16.0 cm, 6 1/4"
F4-195 19.0 cm, 7 1/2"
F4-196 23.0 cm, 9"
F4-197 28.0 cm, 11"

1/1 original
6 1/4"

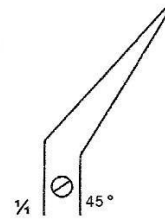

45°
F4-198 16.0 cm, 6 1/4"
F4-199 19.0 cm, 7 1/2"
F4-200 23.0 cm, 9"
F4-201 28.0 cm, 11"

1/1 original
6 1/4"

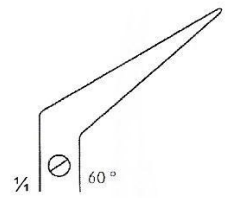

60°
F4-202 16.0 cm, 6 1/4"
F4-203 19.0 cm, 7 1/2"
F4-204 23.0 cm, 9"
F4-205 28.0 cm, 11"

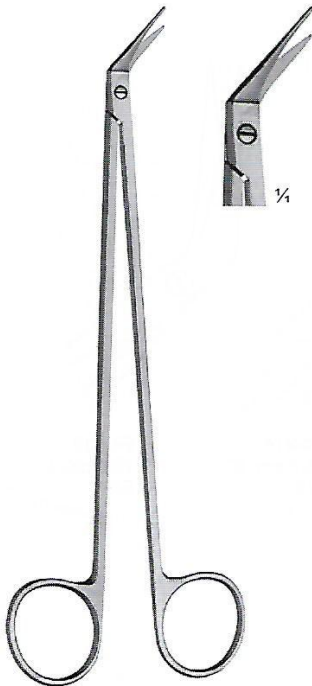

COOLEY VASCULAR SCISSORS
F4-206 18.4 cm, 7 1/2" 1 mm
F4-207 18.4 cm, 7 1/2" 1.5 mm
probe point on tip.
S/S Angled 45°

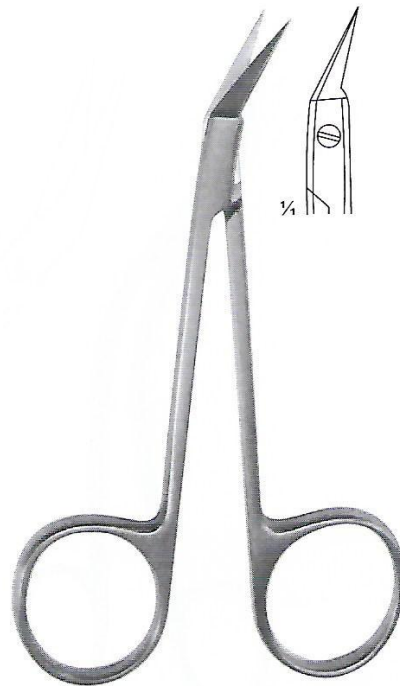

O'BRIEN VASCULAR SCISSORS
F4-208 9.0 cm, 3 1/2"
S/S Angled

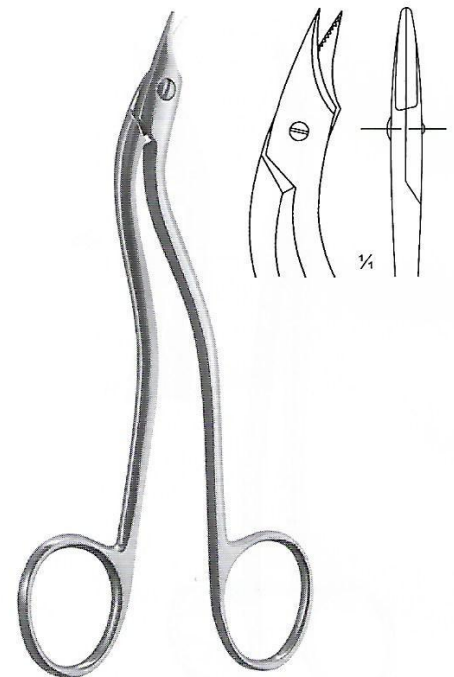

HEATH VASCULAR SCISSORS
F4-209 15.0 cm, 6"
S/S Double Cvd.



DISSECTING & NASAL SCISSORS

Präparierscheren Nasenschere
Tijeras de disección Tijeras Nasal

Ciseaux à dissection Ciseaux Nasal
Dissezione Forbici nasale Forbici

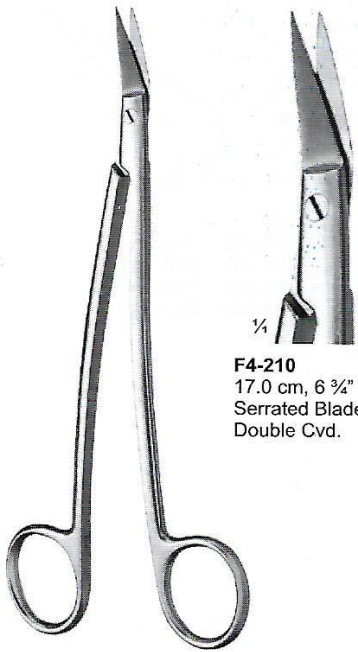

F4-210
17.0 cm, 6 3/4"
Serrated Blade S/S
Double Cvd.

**DEAN-DELICATE
DISSECTING SCISSORS**

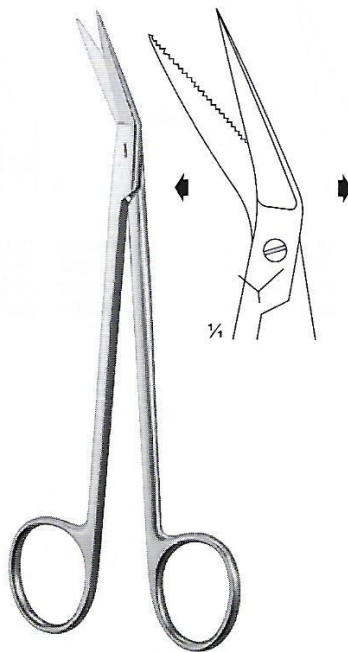

Locklin Dissecting Scissors
F4-211 16.5 cm, 6 1/2"
S/S

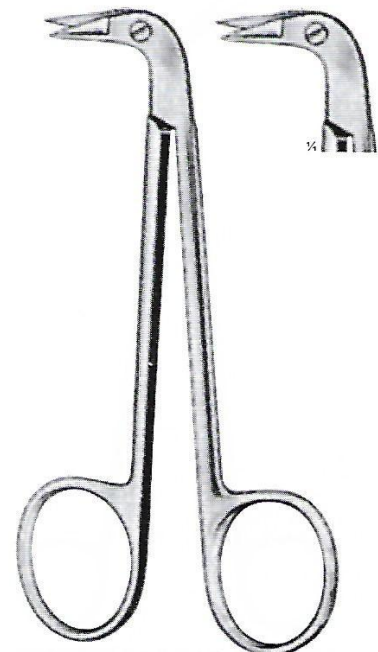

FAVALORO CORONARY
F4-212 10.5 cm, 4"
S/S Angled 90°

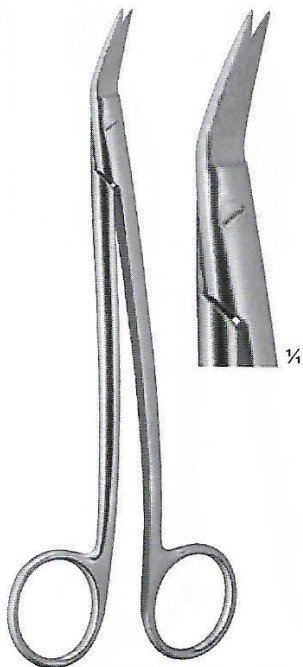

ENT-DEAN SCISSORS
F4-213 17 cm, 6 3/4"
S/S Double Cvd.
Serrated

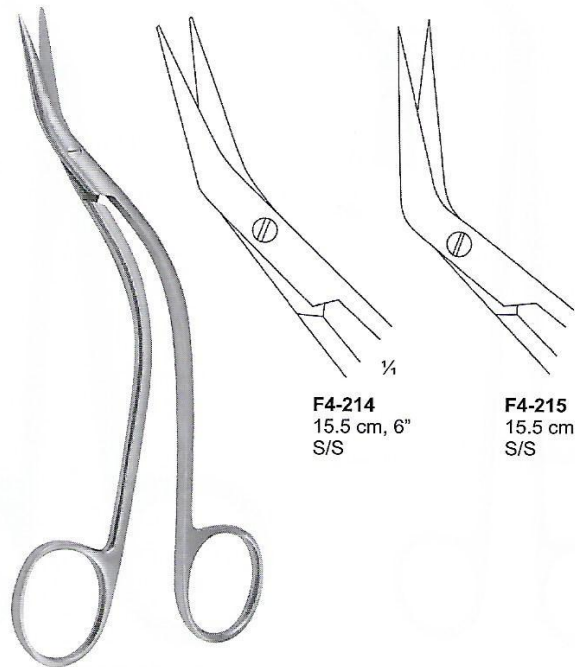

F4-214
15.5 cm, 6"
S/S

F4-215
15.5 cm, 6"
S/S

**DE BAKEY VASCULAR
SCISSORS**

VASCULAR SCISSORS

Gefäßschere

Ciseaux vasculaires

Tijeras vasculares

Forbici vascolari

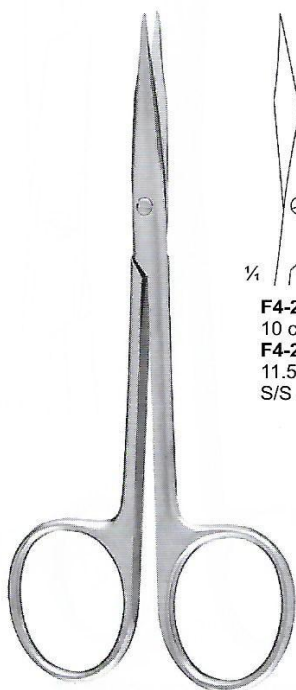

F4-216
10 cm 4"
F4-217
11.5 cm 4 1/2"
S/S Str.

STEVENS SCISSORS



F4-218
10 cm 4"
F4-219
11.5 cm 4 1/2"
S/S Cvd.

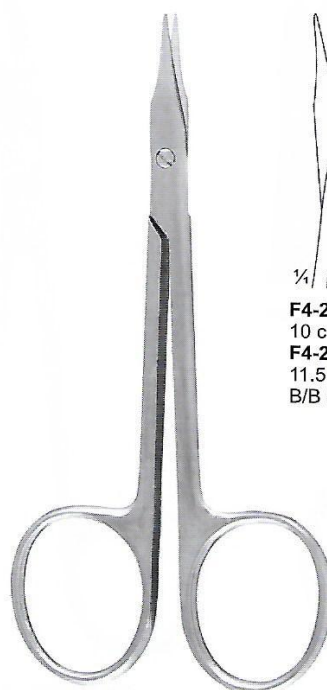

F4-220
10 cm 4"
F4-221
11.5 cm 4 1/2"
B/B Str.

STEVENS SCISSORS



F4-222
10 cm 4"
F4-223
11.5 cm 4 1/2"
B/B Cvd.



NAIL SCISSORS
F4-224 9 cm, 3 1/2"
S/S, Cvd.

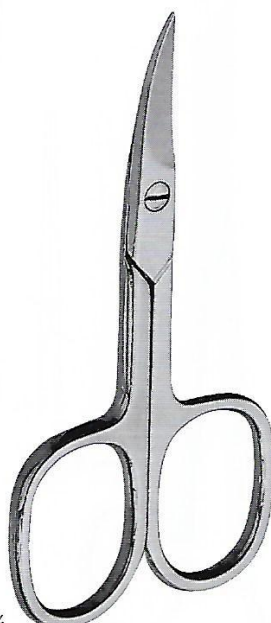

NAIL SCISSORS
F4-225 9 cm, 3 1/2"
S/S, Cvd.



NAIL SCISSORS
F4-226 9 cm, 3 1/2"
Arrow Point Curved



STITCH SCISSORS

stitch Schere | point de ciseaux
Coser Tijeras | Stitch Forbici



1/4
Saw Edge

STITCHES SCISSORS
F4-227 12.0 cm, 4 3/4"
Str.

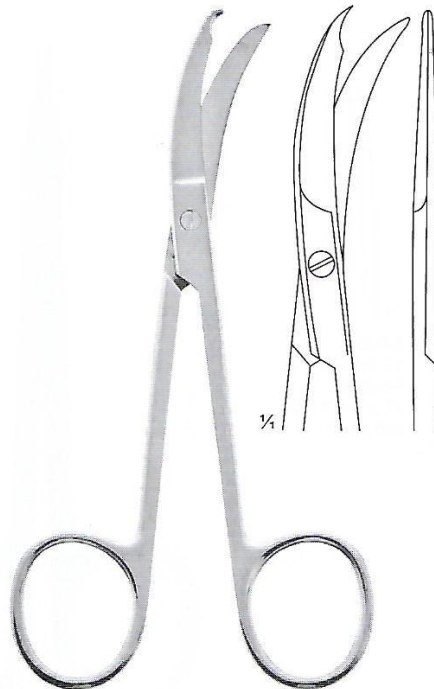

1/4

NORTHBENT STITCHES SCISSORS
F4-228 12.5 cm, 5"
Cvd.

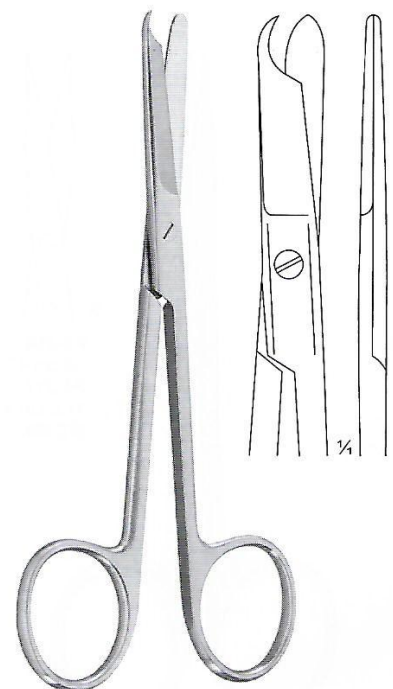

1/4

LITTAUER STITCH SCISSORS
F4-229 14 cm, 5 1/2"
Str.

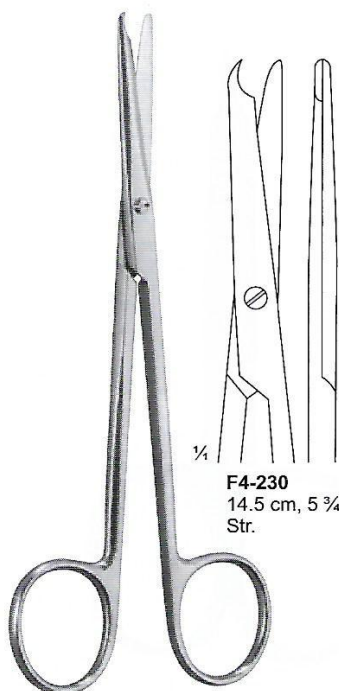

1/4
F4-230
14.5 cm, 5 3/4"
Str.

BUCK STITCH SCISSORS

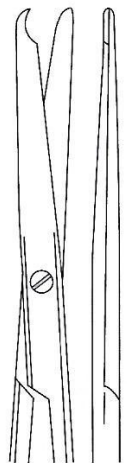

F4-231
18.0 cm, 7"
Str.

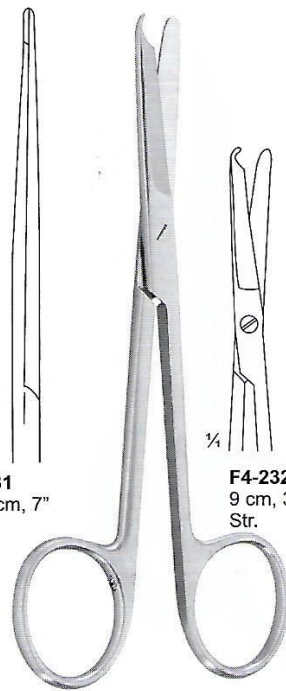

1/4
F4-232
9 cm, 3 1/2"
Str.

SPENCER STITCH SCISSORS

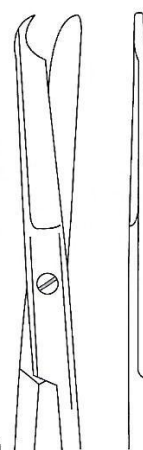

1/4
F4-233
11.5 cm, 4 1/2"
Str.



1/4

SHORTBENT STITCH SCISSORS
F4-234 9 cm, 3 1/2"
Cvd.

TONSIL, NASAL SCISSORS



Tonsillensteine Schere, Nasenschere
Tijeras de amígdalas, tijeras nasales

Ciseaux d'amygdale, Ciseaux nasaux
Tonsille forbici, forbici nasali

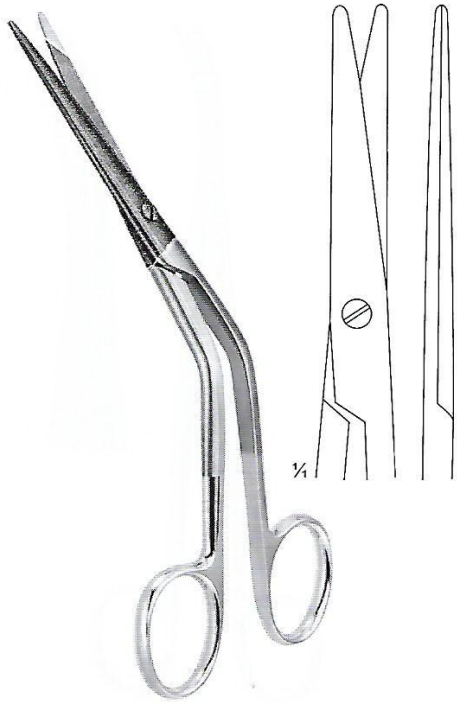

COTTLE SCISSORS
F4-235 16 cm 6 1/4"
B/B, Angled

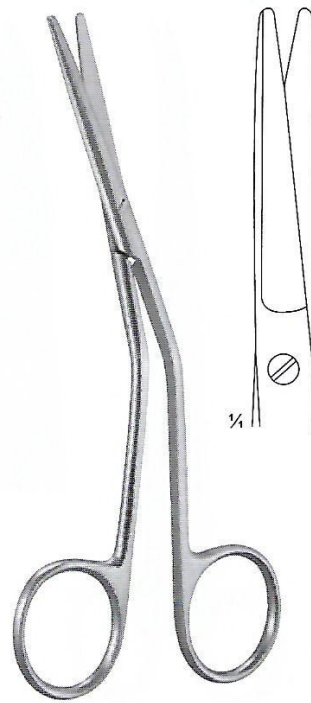

FOMON SCISSORS
F4-236 14.5 cm 5 1/2"
B/B, Angled



SAILER SCISSORS
F4-237 17.0 cm 6 3/4"
B/B, Angled



HEYMANN SCISSORS
F4-238 18 cm, 7"
F4-239 19.5 cm, 7 3/4"
B/B, Angled

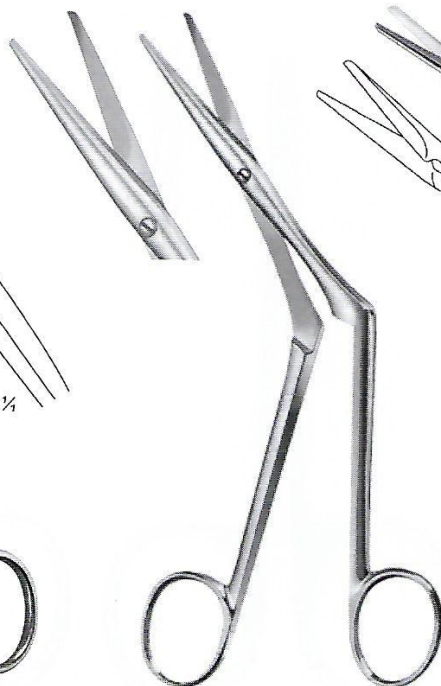

HEYMANN SCISSORS
F4-240 18.0 cm, 7"
B/B, Angled



OLIVECRONA VASCULAR SCISSORS
F4-241 23.0 cm, 9"
B/B



GUM & OPERATING SCISSORS

Chirurgische scheren, Gum Scheren
Goma Tijeras y tijeras de funcionamiento

Gum Ciseaux et Ciseaux d'exploitation
Gum Forbici & Forbici Operativi



GOOD SCISSORS
F4-242 19.0 cm, 7 1/2"
Probe End, Cvd.

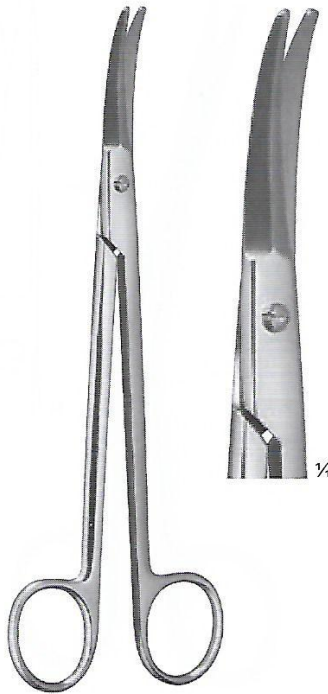

PRINCE SCISSORS
F4-243 17.5 cm, 7"
B/B, Cvd.



HALLE SCISSORS
F4-244 19.0 cm, 7 1/2"
B/B, Cvd.



SULLIVAN SCISSORS
One Teeth Is Serrated As Per

F4-245
14.5 cm, 5 3/4"
Pointed Tip
S/S, Str.



F4-246
14.5 cm, 5 3/4"
Pointed Tip
S/S, Cvd.

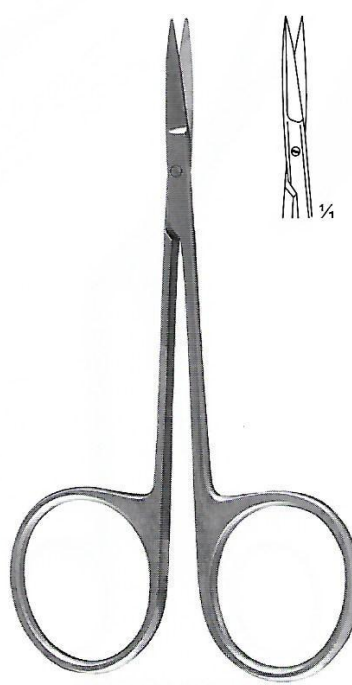

MOD. BONN SCISSORS
F4-247 8.0 cm, 3"
S/S, Str.

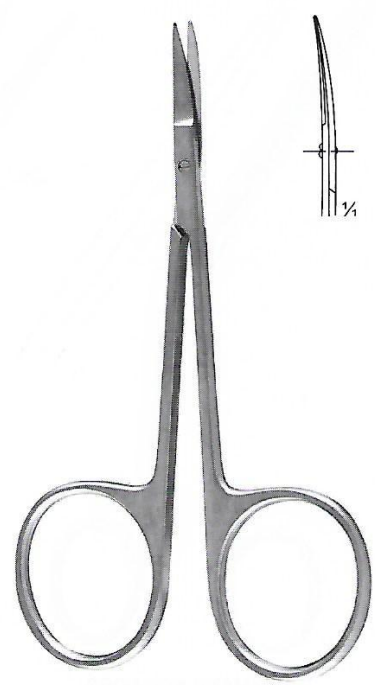
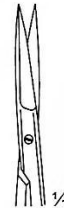

MOD. BONN SCISSORS
F4-248 8.0 cm, 3"
S/S, Cvd.



WIRE CUTTING SCISSORS



Draht-Ausschnitt-Scheren
Tijeras de corte de alambre

Ciseaux de coupe de câbles
Filo da taglio Forbici

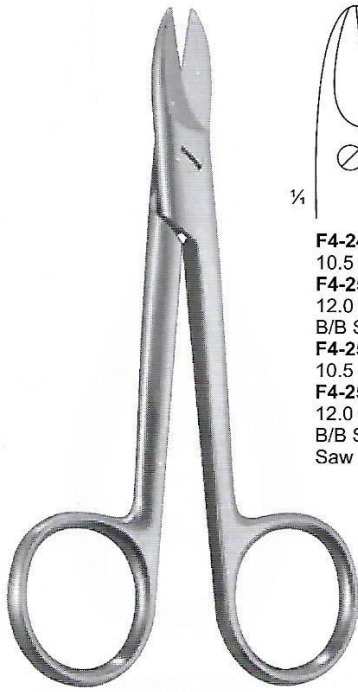

BEEBEE WIRE CUTTING SCISSORS



F4-249
10.5 cm 4 1/4"
F4-250
12.0 cm 4 3/4"
B/B Str.
F4-251
10.5 cm 4 1/4"
F4-252
12.0 cm 4 3/4"
B/B Str.
Saw Edge



F4-253
10.5 cm 4 1/4"
F4-254
12.0 cm 4 3/4"
S/S Str.
F4-255
10.5 cm 4 1/4"
F4-256
12.0 cm 4 3/4"
S/S Str.
Saw Edge

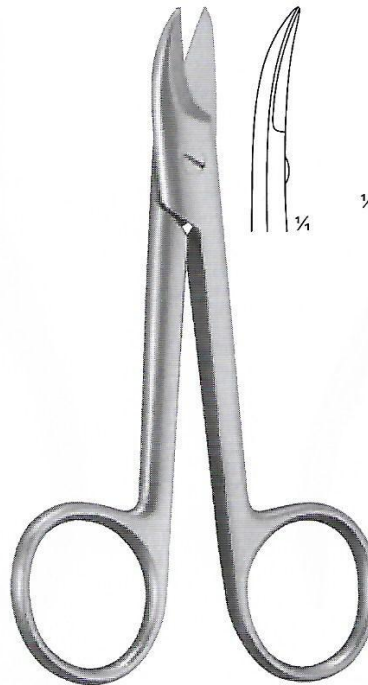

BEEBEE WIRE CUTTING SCISSORS



F4-257
10.0 cm 4"
F4-258
12.0 cm 4 3/4"
B/B Cvd.
F4-259
10.0 cm 4"
F4-260
12.0 cm 4 3/4"
B/B Cvd.
Saw Edge

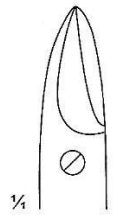

F4-261
10.0 cm 4"
F4-262
12.0 cm 4 3/4"
S/S Cvd.
F4-263
10.0 cm 4"
F4-264
12.0 cm 4 3/4"
S/S Cvd.
Saw Edge



SYSTRUNK SCISSORS



SYSTRUNK
F4-265
13.0 cm 5"
S/S, Str.



SYSTRUNK
F4-266
13.0 cm 5"
S/S, Cvd.

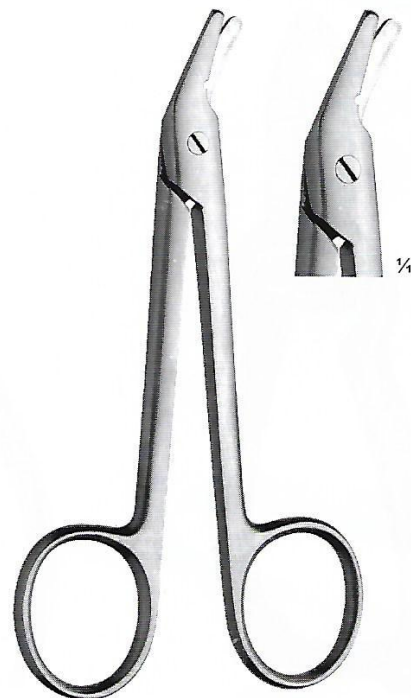

UNIVERSAL WIRE CUTTING SCISSORS
F4-267 12 cm, 4 3/4"



NAIL NIPPERS

Nagelzangen | pincés à ongles
Nail Nippers | Nail Tronchesi



NAIL NIPPERS
F4-268 11 cm 4 1/4"
F4-269 13 cm 5"
F4-270 15 cm 6"



NAIL NIPPERS
F4-271 14 cm 5 1/2"



NAIL NIPPERS
F4-272 14 cm 5 1/2"



TURNBULL NIPPERS
F4-273 11.5 cm 4 1/2"
F4-274 13 cm 5"



NAIL NIPPERS
F4-275 10.5 cm 4 1/4"



COHEN NIPPERS
F4-276 10.5 cm 4 1/4"

MICRO SCISSORS



Mikroscheren | micro Ciseaux
 Micro Tijeras | Micro Forbici

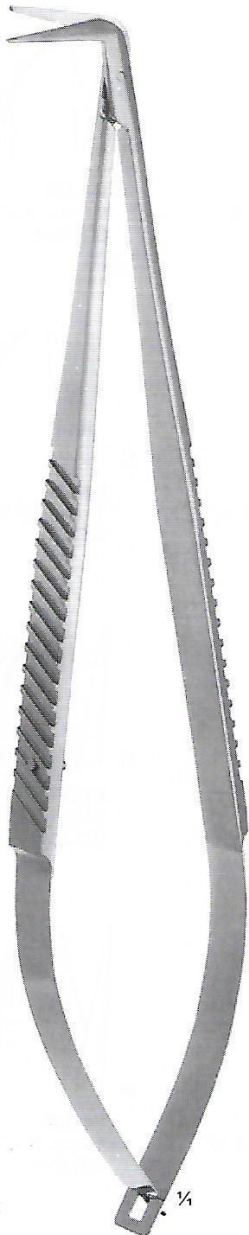

ARTERY SCISSORS
 Probe end Angled

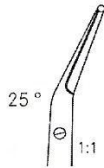

F4-277
 18.0 cm, 7"
 25°

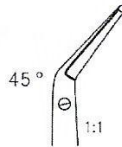

F4-278
 18.0 cm, 7"
 45°

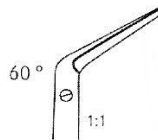

F4-279
 18.0 cm, 7"
 60°

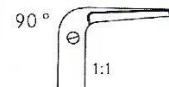

F4-280
 18.0 cm, 7"
 90°

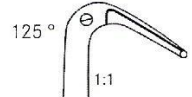

F4-281
 18.0 cm, 7"
 125°

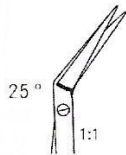

F4-282
 18.0 cm, 7"
 25°

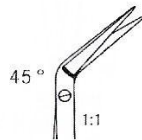

F4-283
 18.0 cm, 7"
 45°

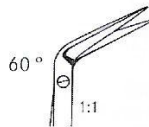

F4-284
 18.0 cm, 7"
 60°

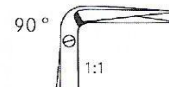

F4-285
 18.0 cm, 7"
 90°

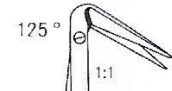

F4-286
 18.0 cm, 7"
 125°



MICRO SCISSORS

Mikroscheren | *micro Ciseaux*
Micro Tijeras | *Micro Forbici*

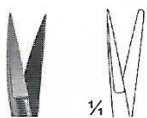

F4-287
9.0 cm, 3 1/2"
S/B Str.

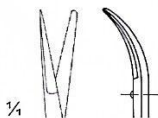

F4-288
9.0 cm, 3 1/2"
S/B Cvd.



F4-289
9.0 cm, 3 1/2"
S/S Str.



F4-290
9.0 cm, 3 1/2"
S/S Cvd.



F4-291
11.4 cm, 4 1/2"
B/B Str.

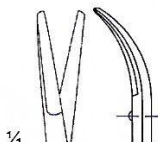

F4-292
11.4 cm, 4 1/2"
B/B Cvd.



F4-293
11.4 cm, 4 1/2"
S/B Str.

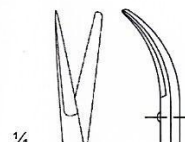

F4-294
11.4 cm, 4 1/2"
S/B Cvd.



F4-295
11.4 cm, 4 1/2"
S/S Str.

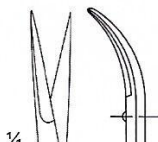

F4-296
11.4 cm, 4 1/2"
S/S Cvd.



F4-297
14 cm, 5 1/2"
B/B Str.

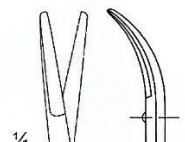

F4-298
14 cm, 5 1/2"
B/B Cvd.



F4-299
14 cm, 5 1/2"
S/B Str.

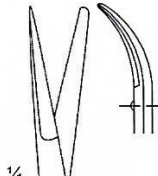

F4-300
14 cm, 5 1/2"
S/B Cvd.



F4-301
14 cm, 5 1/2"
S/S Str.

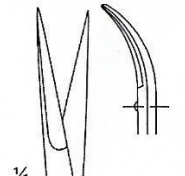

F4-302
14 cm, 5 1/2"
S/S Cvd.



CASTROVIEJO SCISSORS
Spring Type

MICRO SCISSORS



Mikroscheren | micro Ciseaux
 Micro Tijeras | Micro Forbici



F4-303
 12 cm, 4 3/4"
 S/S



F4-304
 12 cm, 4 3/4"
 S/B

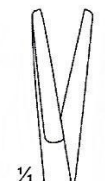

F4-305
 12 cm, 4 3/4"
 B/B



NOYES SCISSORS
 Spring Handle
F4-306 12 cm, 4 3/4"
 Angled,

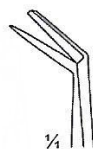

F4-307
 11.0 cm, 4 1/4"
 S/B

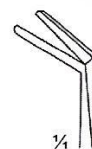

F4-308
 11.0 cm, 4 1/4"
 B/B



F4-309
 11.0 cm, 4 1/4"
 S/S

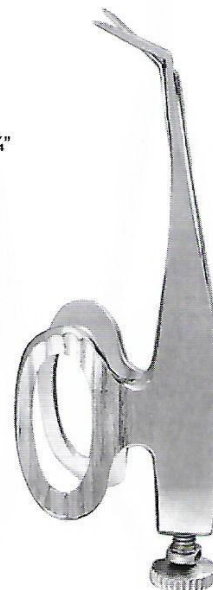

BARRAQUER SCISSORS
F4-310 Sharp Points
F4-311 Blunt Points
 5.5 cm, 2 1/4"



CASTROVIEJO CORNEAL MICRO SCISSORS
F4-312 11 cm, 4 1/3"
 Left Angled,
 Spring Handle



CASTROVIEJO CORNEAL MICRO SCISSORS
F4-313 11 cm, 4 1/3"
 Right Angled,
 Spring Handle



TROUTMAN MICRO SCISSORS
F4-314 10.0 cm, 4"
 Left Angled,
 Spring Handle



TROUTMAN MICRO SCISSORS
F4-315 10.0 cm, 4"
 Right Angled,
 Spring Handle

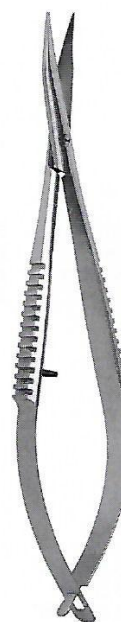

F4-316
 11.0 cm, 4 1/4"
 S/S Str.



F4-318
 11.0 cm, 4 1/4"
 S/S Cvd.

F4-319
 13.3 cm, 5 1/4"
 S/S Str.

WESTCOTT MICRO SCISSORS



MICRO SCISSORS

Mikroscheren | micro Ciseaux
Micro Tijeras | Micro Forbici



MICRO SCISSORS
F4-320 12.0 cm, 4 3/4"
S/S, Cvd.

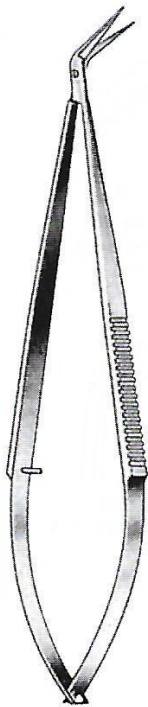

MICRO SCISSORS
S/S, Angled

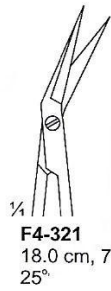

F4-321
18.0 cm, 7"
25°



F4-322
18.0 cm, 7"
45°

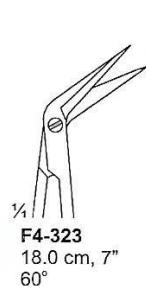

F4-323
18.0 cm, 7"
60°

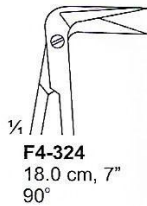

F4-324
18.0 cm, 7"
90°

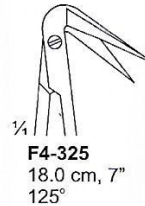

F4-325
18.0 cm, 7"
125°

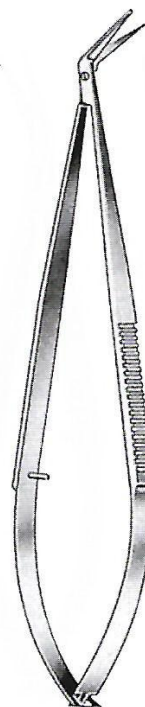

MICRO SCISSORS
S/S, Angled pointed probe

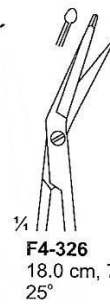

F4-326
18.0 cm, 7"
25°

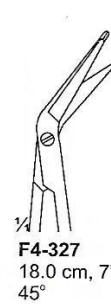

F4-327
18.0 cm, 7"
45°

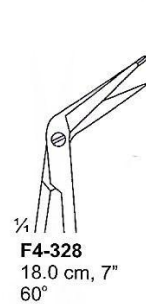

F4-328
18.0 cm, 7"
60°

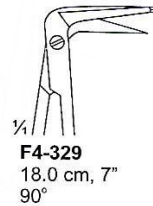

F4-329
18.0 cm, 7"
90°

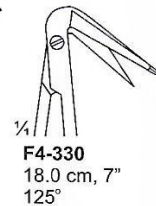

F4-330
18.0 cm, 7"
125°



YASARGILL SCISSORS



F4-331 16 cm, 6 1/4"
F4-332 20 cm, 8"
F4-333 22.5 cm, 9"
S/S, Str.



F4-334 16 cm, 6 1/4"
F4-335 20 cm, 8"
F4-336 22 cm, 8 3/4"
S/S, Cvd.



F4-337 16 cm, 6 1/4"
F4-338 20 cm, 8"
F4-339 22 cm, 8 3/4"
B/B, Str.



F4-340 16 cm, 6 1/4"
F4-341 20 cm, 8"
F4-342 22 cm, 8 3/4"
S/S, Str.



F4-343 16 cm, 6 1/4"
F4-344 20 cm, 8"
F4-345 22 cm, 8 3/4"
S/S, Cvd.



F4-346 16 cm, 6 1/4"
F4-347 20 cm, 8"
F4-348 22 cm, 8 3/4"
B/B, Cvd.



NOYES MICRO SCISSORS
F4-349 15.0 cm, 6"
S/S

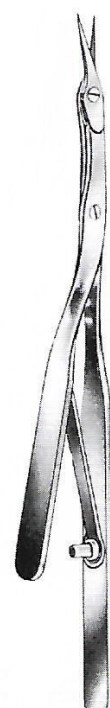

NOYES MICRO SCISSORS
F4-350 14.5 cm, 5 3/4"
S/S

UNIVERSAL SCISSORS

Universal-Schere
Tijeras universales

Ciseaux universelles
Forbici universali



UNIVERSAL PARAMEDIC SHEAR

- F4-351 14 cm 5 3/4" (BLACK)
- F4-352 14 cm 5 3/4" (BLUE)
- F4-353 14 cm 5 3/4" (ROYAL BLUE)
- F4-354 14 cm 5 3/4" (BURGANDY)
- F4-355 14 cm 5 3/4" (GREEN)
- F4-356 14 cm 5 3/4" (MAGENTA)
- F4-357 14 cm 5 3/4" (ORANGE)
- F4-358 14 cm 5 3/4" (PINK)
- F4-359 14 cm 5 3/4" (PURPLE)
- F4-360 14 cm 5 3/4" (RED)
- F4-361 14 cm 5 3/4" (TEAL)
- F4-362 14 cm 5 3/4" (WHITE)
- F4-363 14 cm 5 3/4" (YELLOW)

- F4-364 16 cm 6 1/4" (BLACK)
- F4-365 16 cm 6 1/4" (BLUE)
- F4-366 14 cm 5.5" (ROYAL BLUE)
- F4-367 14 cm 5.5" (BURGANDY)
- F4-368 16 cm 6 1/4" (GREEN)
- F4-369 16 cm 6 1/4" (MAGENTA)
- F4-370 16 cm 6 1/4" (ORANGE)
- F4-371 16 cm 6 1/4" (PINK)
- F4-372 16 cm 6 1/4" (PURPLE)
- F4-373 16 cm 6 1/4" (RED)
- F4-374 16 cm 6 1/4" (TEAL)
- F4-375 16 cm 6 1/4" (WHITE)
- F4-376 16 cm 6 1/4" (YELLOW)

143 C/290 F Autoclavable



UNIVERSAL SCISSORS

Universal-Schere
Tijeras universales

Ciseaux universelles
Forbici universali

**UNIVERSAL
PARAMEDIC SHEAR
F4-377**
14 cm 5.5"
(GREEN)



**UNIVERSAL
PARAMEDIC SHEAR
F4-382**
14 cm 5.5"
(PINK)



**UNIVERSAL
PARAMEDIC SHEAR
F4-378**
14 cm 5.5"
(ROYAL BLUE)



**UNIVERSAL
PARAMEDIC SHEAR
F4-381**
14 cm 5.5"
(BURGANDY)



**UNIVERSAL
PARAMEDIC SHEAR
F4-379**
14 cm 5.5"
(RED)



**UNIVERSAL
PARAMEDIC SHEAR
F4-380**
14 cm 5.5"
(BLACK)

UNIVERSAL SCISSORS



Universal-Schere
Tijeras universales

Ciseaux universelles
Forbici universali

UNIVERSAL PARAMEDIC
SHEAR PROB END
F4-383
14 cm 5.5"
(YELLOW)



UNIVERSAL PARAMEDIC
SHEAR PROB END
F4-390
14 cm 5.5"
(ROYAL BLUE)



UNIVERSAL PARAMEDIC
SHEAR PROB END
F4-384
14 cm 5.5"
(Chartreuse)



UNIVERSAL PARAMEDIC
SHEAR PROB END
F4-389
14 cm 5.5"
(WHITE)



UNIVERSAL PARAMEDIC
SHEAR PROB END
F4-385
14 cm 5.5"
(RED)



UNIVERSAL PARAMEDIC
SHEAR PROB END
F4-386
14 cm 5.5"
(BLACK)



UNIVERSAL PARAMEDIC
SHEAR PROB END
F4-388
14 cm 5.5"
(GREEN)



UNIVERSAL PARAMEDIC
SHEAR PROB END
F4-387
14 cm 5.5"
(BURGUNDY)





UNIVERSAL SCISSORS

Universal-Schere
Tijeras universales

Ciseaux universelles
Forbici universali

**UNIVERSAL
PARAMEDIC SHEAR
F4-391**
14 cm 5.5"
(BLACK)



**UNIVERSAL
PARAMEDIC SHEAR
F4-395**
14 cm 5.5"
(BLUE)



**UNIVERSAL
PARAMEDIC SHEAR
F4-392**
14 cm 5.5"
(ORANGE)



**UNIVERSAL
PARAMEDIC SHEAR
F4-396**
14 cm 5.5"
(YELLOW)

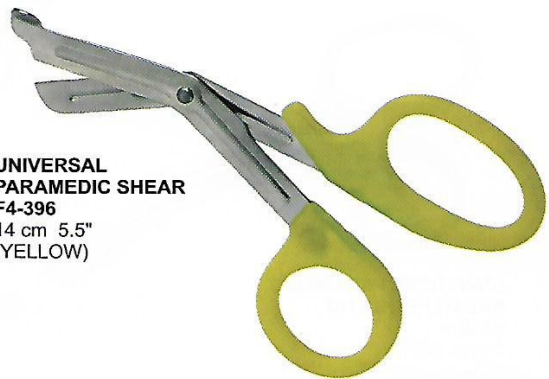

**UNIVERSAL
PARAMEDIC SHEAR
F4-393**
14 cm 5.5"
(WHITE)



**UNIVERSAL
PARAMEDIC SHEAR
F4-397**
14 cm 5.5"
(BURGUNDY)



**UNIVERSAL
PARAMEDIC SHEAR
F4-394**
14 cm 5.5"
(ORANGE)



**UNIVERSAL
PARAMEDIC SHEAR
F4-398**
14 cm 5.5"
(DEEP YELLOW)

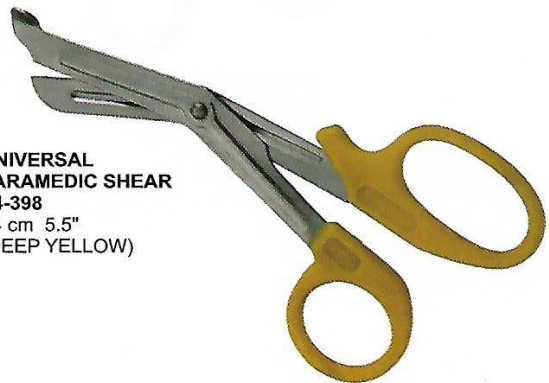

PLASTER SCISSORS



Gips Schere
Tijeras Yeso

plâtre Ciseaux
intonaco Forbici



ESMARCH KNIFE
F4-399 18 cm, 7"

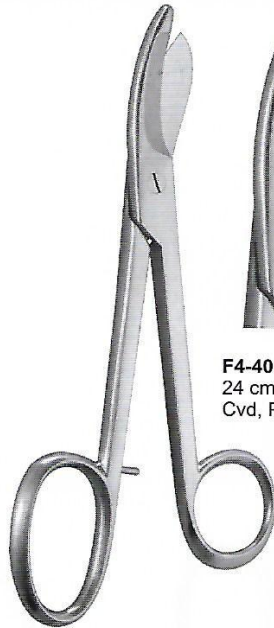

BRUNS SCISSORS



F4-400
24 cm, 9 1/2"
Cvd, Probe End



F4-401
24 cm, 9 1/2"
Cvd, Serrated
Probe End

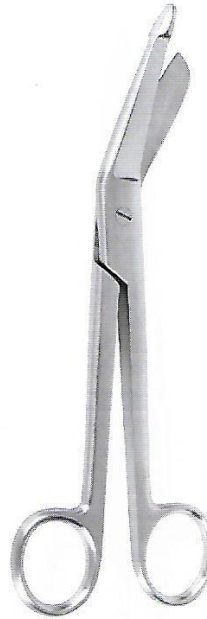

**LISTER-EXCENTRIC
PLASTER SCISSORS**
F4-402 16 cm, 6 1/4"
F4-403 19 cm, 7 1/2"
Angled, Probe End



Edge Upper
h is Serrated

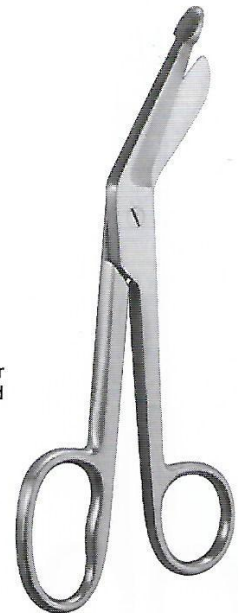

**LISTER BANDAGE PLASTER
SCISSORS**, one large ring
F4-404 9 cm, 3 1/2"
F4-405 11 cm, 4 1/3"
F4-406 14 cm, 5 1/2"
F4-407 15 cm, 6"
F4-408 18 cm, 7"
F4-409 20 cm, 8"
Angled, Probe End



BERGMANN SCISSORS
F4-410 23 cm, 9"
Angled, Probe End



ESMARCH SCISSORS
F4-411 20 cm, 8"
F4-412 23 cm, 9"
Angled, Probe End

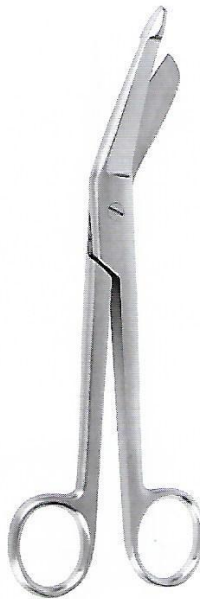

**LISTER BANDAGE
PLASTER SCISSORS**
F4-413 9 cm, 3 1/2"
F4-414 11 cm, 4 1/3"
F4-415 14 cm, 5 1/2"
F4-416 15 cm, 6"
F4-417 18 cm, 7"
F4-418 20 cm, 8"
Angled, Probe End



PLASTER SCISSORS
F4-419 17 cm, 6 3/4"
Angled



**BURNHAM BANDAGE
PLASTER SCISSORS**
F4-420 14 cm, 5 1/2"
Angled



PLASTER SCISSORS

Gips Schere
Tijeras Yeso

plâtre Ciseaux
intonaco Forbici

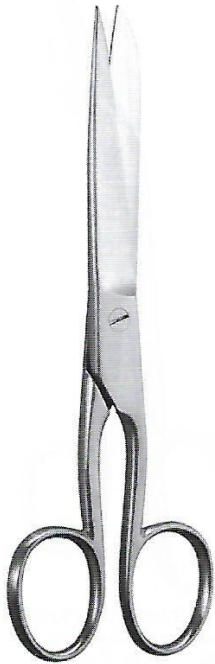

BANDAGE SCISSORS
F4-421
16.0 cm 6 1/4"

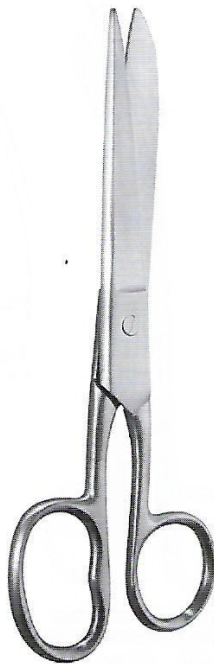

**SMITH (Mod. Usa)
PLASTER SCISSORS**
F4-422 16 cm, 6 1/4"
F4-423 18 cm, 7"
F4-424 20 cm, 8"
F4-425 23 cm, 9"

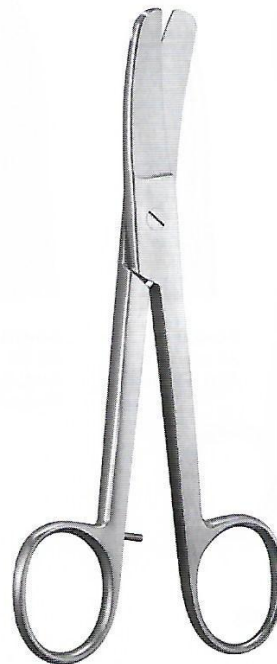

**LORENZ PLASTER
SCISSORS**
F4-426 23 cm, 9"
B/B, Cvd



**LANGE BANDAGE
SCISSORS**
F4-427 18.0 cm 7"
B/B



**BRAUN-STADLER
PLASTER SCISSORS**
F4-428 14 cm, 5 1/2"
F4-429 22 cm, 8 3/4"
B/B, Angled

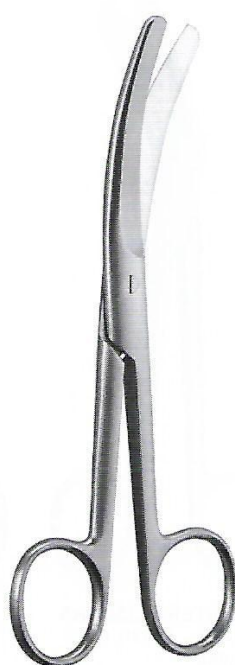

**BUSCH PLASTER
SCISSORS**
F4-430 13 cm, 5"
F4-431 16 cm, 6 1/4"
B/B, Cvd.



**KNOWLES PLASTER
SCISSORS**
F4-432 14 cm, 5 1/2"
Str. Probe End

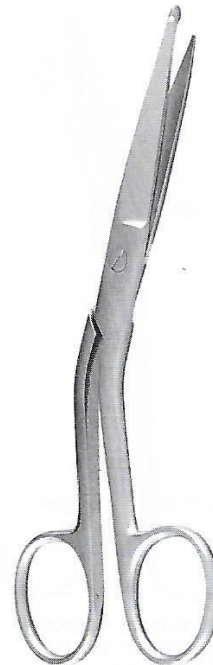

**KNOWLES PLASTER
SCISSORS**
F4-433 14 cm, 5 1/2"
Angled, Probe End



**WALDMANN PLASTER
SCISSORS**
F4-434 18 cm, 7"
Probe End

PLASTER SCISSORS



Gips Schere
Tijeras Yeso

plâtre Ciseaux
intonaco Forbici

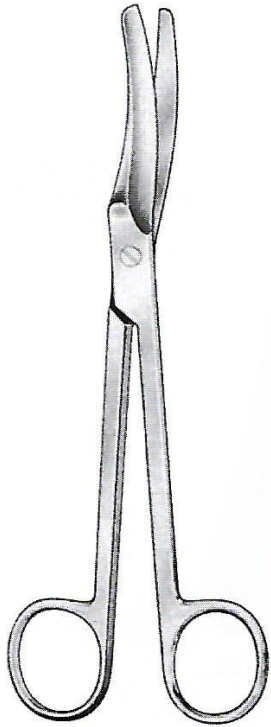

WALDMANN SCISSORS
F4-435 18 cm, 7"



SCHUMACHER PLASTER SCISSORS
F4-436 16 cm, 6 1/4"



MODIFIED-USA PLASTER SCISSORS
F4-437 10.5 cm, 4 1/4"



MARBACH PLASTER SCISSORS
F4-438 15.5 cm, 6"
Probe End, Serrated blade



SEUTIN PLASTER SCISSORS
F4-439 20.0 cm 8"
Probe End



SEUTIN PLASTER SCISSORS
F4-440 23.0 cm 9"
Probe End



PLASTER SHEARS

GipsScheren | plâtres Ciseaux
Tijeras Yeso | Cesoie in gesso



STILLE PLASTER SHEARS
F4-441 23 cm, 9"
F4-442 Spare Blade



STILLE PLASTER SHEARS
F4-443 26 cm, 10 1/2"
F4-444 Spare Blade



STILLE PLASTER SHEARS
F4-445 37 cm, 14 1/2"
F4-446 Spare Blade

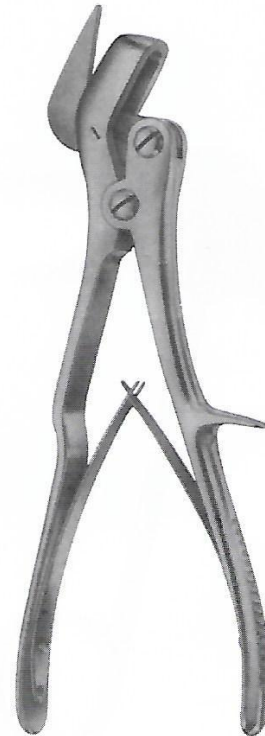

STILLE PLASTER SHEARS
F4-447 24 cm, 9 1/2"
F4-448 Spare Blade

PLASTER SHEARS

GipsScheren
Tijeras Yeso

plâtres Ciseaux
Cesoie in gesso

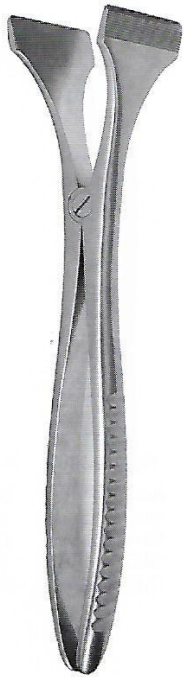

HENNIG PLASTER CAST SPREADER
F4-449 28 cm, 11"



MODEL USA CAST SPREADER PLASTER
F4-450 23 cm, 9" 3 Prong

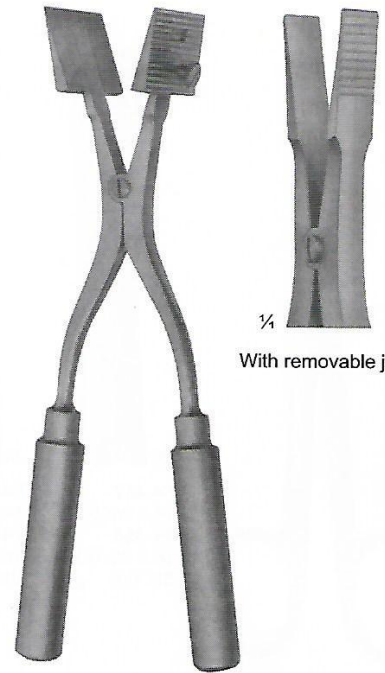

SPREADER PLASTER
F4-451 29 cm, 11 1/2"
With removable jaws



WOLFF SPREADER PLASTER
F4-452 18 cm, 7"
F4-453 24 cm, 9 1/2"

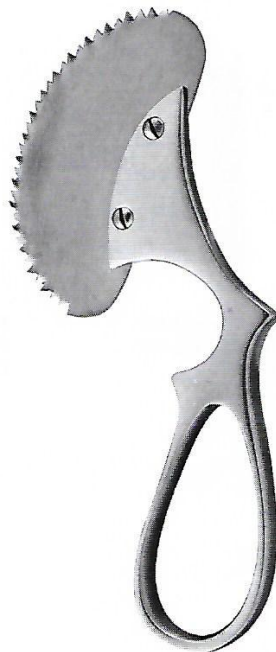

ENGEL PLASTER SAW
F4-454 14 cm, 5 1/2"

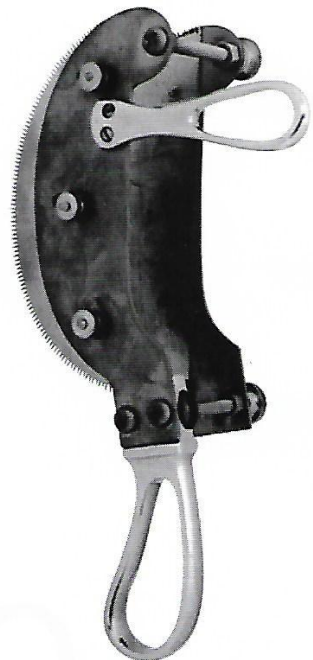

CHARRIERE PLASTER SAW
F4-455 25 cm, 10"
F4-456 27 cm, 10 3/4"
Double saw



SUPER CUT SCISSORS

Super Cut Schere
Súper Cut Tijeras

Ciseaux SuperCut
Forbici SuperCut

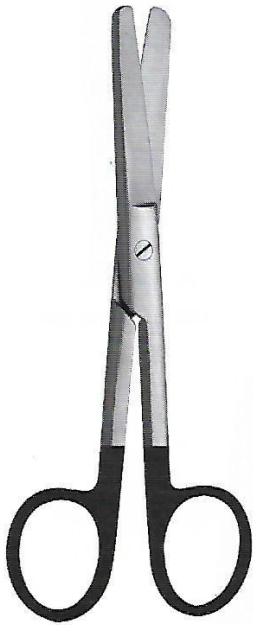

STANDARD OPERATING
SUPER CUT SCISSORS



F4-457
14.5 cm 5 3/4"
F4-458
16.5 cm 6 1/2"
Str. B/B



F4-459
14.5 cm 5 3/4"
F4-460
16.5 cm 6 1/2"
Str. S/B



F4-461
14.5 cm 5 3/4"
F4-462
16.5 cm 6 1/2"
Str. S/S

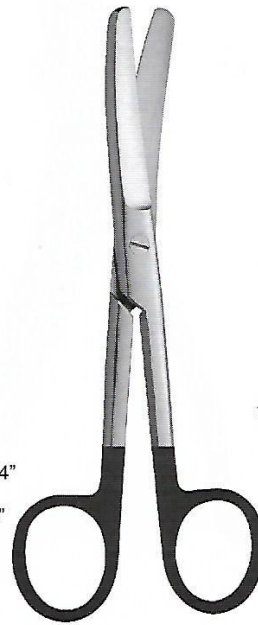

STANDARD OPERATING
SUPER CUT SCISSORS



F4-463
14.5 cm 5 3/4"
F4-464
16.5 cm 6 1/2"
Cvd. B/B



F4-465
14.5 cm 5 3/4"
F4-466
16.5 cm 6 1/2"
Cvd. S/B



F4-467
14.5 cm 5 3/4"
F4-468
16.5 cm 6 1/2"
Cvd. S/S

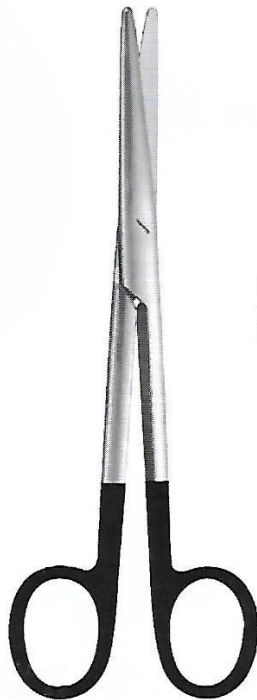

LAXER OPERATING SUPER
CUT SCISSORS



F4-469 16 cm 6 1/4"
F4-470 21 cm 8 1/4"
B/B, Str.



F4-471 16.5 cm 5 1/2"
F4-472 21 cm 8 1/4"
B/B, Cvd.

SUPER CUT SCISSORS

Super Cut Schere
Super Cut Tijeras

Ciseaux SuperCut
Forbici SuperCut



SAFETY SUPER CUT SCISSORS
F4-473 Str.
F4-474 Cvd.
9.0 cm, 3 1/2", Probe Ends

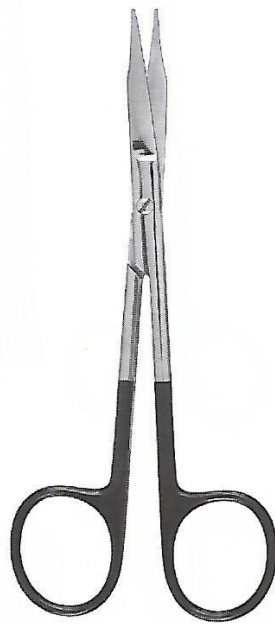

**GOLDMAN-FOX
SUPER CUT SCISSORS**
F4-475 Str.
F4-476 Cvd.
9.0 cm, 3 1/2", S/S
13 cm 5"



**STEVENS TENOTOMY
SUPER CUT SCISSORS**
F4-477 Str.
F4-478 Cvd.
9.0 cm, 3 1/2", B/B

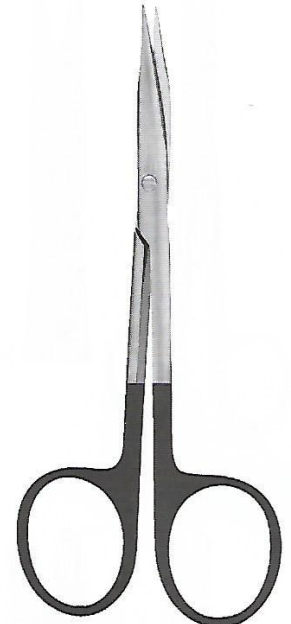

**STEVENS TENOTOMY
SUPER CUT SCISSORS**
F4-479 Str.
F4-480 Cvd.
11.5 cm, 4 1/2", S/S



**BABY METZENBAUM
SUPER CUT SCISSORS**
F4-481 11.5 cm, 4 1/2"
B/B, Str.



**BABY METZENBAUM
SUPER CUT SCISSORS**
F4-482 11.5 cm, 4 1/2"
B/B, Cvd.



IRIS SUPER CUT SCISSORS
F4-483 9.0 cm, 3 1/2"
F4-484 11.5 cm, 4 1/2"
S/S, Str.



IRIS SUPER CUT SCISSORS
F4-485 9.0 cm, 3 1/2"
F4-486 11.5 cm, 4 1/2"
S/S, Cvd.



OPERATING SCISSORS T.C.

Chirurgische scheren
Tijeras quirúrgicas

Ciseaux chirurgicaux
Forbici per chirurgia

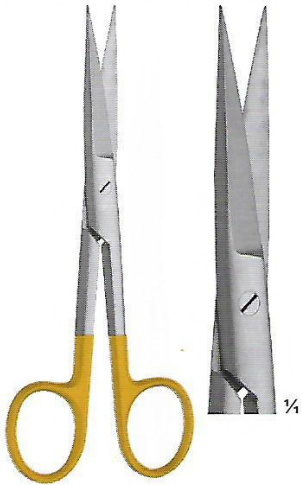

**Operating Scissors, S/S Str.
T/C Insert**

TCF4-487	11.5 cm, 4 1/2"
TCF4-488	13.0 cm, 5"
TCF4-489	14.0 cm, 5 1/2"
TCF4-490	15.0 cm, 6"
TCF4-491	16.0 cm, 6 1/4"
TCF4-492	17.5 cm, 7"
TCF4-493	18.5 cm, 7 1/4"
TCF4-494	20.0 cm, 8"

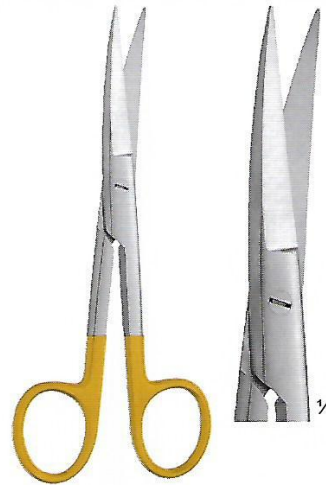

**Operating Scissors, S/S Cvd.
T/C Insert**

TCF4-495	11.5 cm, 4 1/2"
TCF4-496	13.0 cm, 5"
TCF4-497	14.0 cm, 5 1/2"
TCF4-498	15.0 cm, 6"
TCF4-499	16.0 cm, 6 1/4"
TCF4-500	17.5 cm, 7"
TCF4-501	18.5 cm, 7 1/4"
TCF4-502	20.0 cm, 8"



**Operating Scissors, B/B Str.
T/C Insert**

TCF4-503	11.5 cm, 4 1/2"
TCF4-504	13.0 cm, 5"
TCF4-505	14.0 cm, 5 1/2"
TCF4-506	15.0 cm, 6"
TCF4-507	16.0 cm, 6 1/4"
TCF4-508	17.5 cm, 7"
TCF4-509	18.5 cm, 7 1/4"
TCF4-510	20.0 cm, 8"



**Operating Scissors, B/B Cvd.
T/C Insert**

TCF4-511	11.5 cm, 4 1/2"
TCF4-512	13.0 cm, 5"
TCF4-513	14.0 cm, 5 1/2"
TCF4-514	15.0 cm, 6"
TCF4-515	16.0 cm, 6 1/4"
TCF4-516	17.5 cm, 7"
TCF4-517	18.5 cm, 7 1/4"
TCF4-518	20.0 cm, 8"



**Operating Scissors, S/B
Standard Str. T/C Insert**

TCF4-519	11.5 cm, 4 1/2"
TCF4-520	13.0 cm, 5"
TCF4-521	14.0 cm, 5 1/2"
TCF4-522	15.0 cm, 6"
TCF4-523	16.0 cm, 6 1/4"
TCF4-524	17.5 cm, 7"
TCF4-525	18.5 cm, 7 1/4"
TCF4-526	20.0 cm, 8"

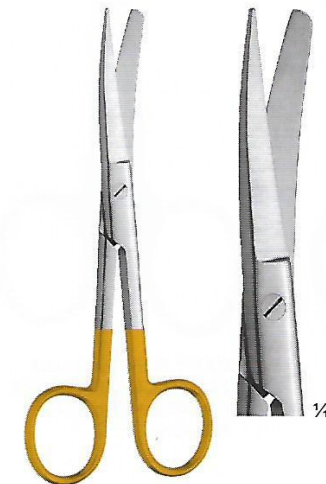

**Operating Scissors, S/B
Standard Cvd. T/C Insert**

TCF4-527	11.5 cm, 4 1/2"
TCF4-528	13.0 cm, 5"
TCF4-529	14.0 cm, 5 1/2"
TCF4-530	15.0 cm, 6"
TCF4-531	16.0 cm, 6 1/4"
TCF4-532	17.5 cm, 7"
TCF4-533	18.5 cm, 7 1/4"
TCF4-534	20.0 cm, 8"

OPERATING SCISSORS T.C.



Chirurgische scheren
Tijeras quirúrgicas

Ciseaux chirurgicaux
Forbici per chirurgia



Metzenbaum Operating Scissors T/C Insert

¼

TCF4-535
11.5 cm 4 ½"
TCF4-536
14.5 cm 5 ¾"
B/B Str.

¼

TCF4-537
11.5 cm 4 ½"
TCF4-538
14.5 cm 5 ¾"
S/B Str.

¼

TCF4-539
11.5 cm 4 ½"
TCF4-540
14.5 cm 5 ¾"
S/S Str.

¼

TCF4-541
11.5 cm 4 ½"
TCF4-542
14.5 cm 5 ¾"
B/B Cvd.

¼

TCF4-543
11.5 cm 4 ½"
TCF4-544
14.5 cm 5 ¾"
S/B Cvd.

¼

TCF4-545
11.5 cm 4 ½"
TCF4-546
14.5 cm 5 ¾"
S/S Cvd.



Metzenbaum Operating Scissors T/C Insert

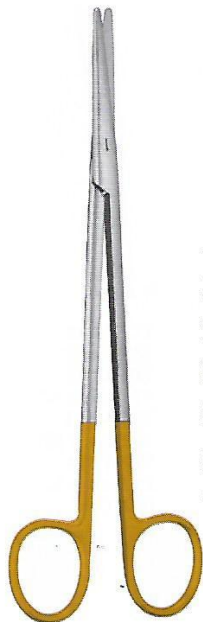

Metzenbaum-Nelson Operating Scissors T/C Insert

¼

TCF4-547
18 cm 7"
TCF4-548
20 cm 8"
TCF4-549
23 cm 9"
TCF4-550
25 cm 10"
TCF4-551
28 cm 11"
TCF4-552
30 cm 12"
B/B Str.

¼

TCF4-553
18 cm 7"
TCF4-554
20 cm 8"
TCF4-555
23 cm 9"
TCF4-556
25 cm 10"
TCF4-557
28 cm 11"
TCF4-558
30 cm 12"
S/B Str.

¼

TCF4-559
18 cm 7"
TCF4-560
20 cm 8"
TCF4-561
23 cm 9"
TCF4-562
25 cm 10"
TCF4-563
28 cm 11"
TCF4-564
30 cm 12"
S/S Str.

¼

TCF4-565
18 cm 7"
TCF4-566
20 cm 8"
TCF4-567
23 cm 9"
TCF4-568
25 cm 10"
TCF4-569
28 cm 11"
TCF4-570
30 cm 12"
B/B Cvd.

¼

TCF4-571
18 cm 7"
TCF4-572
20 cm 8"
TCF4-573
23 cm 9"
TCF4-574
25 cm 10"
TCF4-575
28 cm 11"
TCF4-576
30 cm 12"
S/B Cvd.

¼

TCF4-577
18 cm 7"
TCF4-578
20 cm 8"
TCF4-579
23 cm 9"
TCF4-580
25 cm 10"
TCF4-581
28 cm 11"
TCF4-582
30 cm 12"
S/S Cvd.

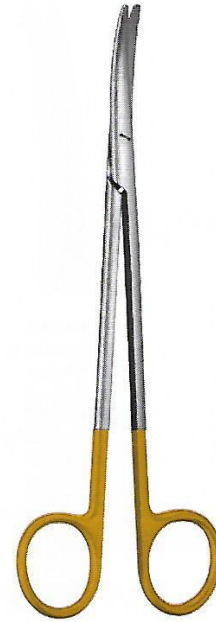

Metzenbaum-Nelson Operating Scissors T/C Insert



OPERATING & GYNECOLOGICAL SCISSORS T.C

Betriebs- und Gynäkologische Scheren
Operación y tijeras ginecológicas

Exploitation & ciseaux gynécologiques
Forbici ginecologiche Operativo e



¼

TCF4-583 14.5 cm 5 3/4"
TCF4-584 18 cm 7"
TCF4-585 20 cm 8"
TCF4-586 23 cm 9"
B/B Str.

¼

TCF4-587 14.5 cm 5 3/4"
TCF4-588 18 cm 7"
TCF4-589 20 cm 8"
TCF4-590 23 cm 9"
B/B Cvd.

¼

TCF4-591 14.5 cm 5 3/4"
TCF4-592 18 cm 7"
TCF4-593 20 cm 8"
TCF4-594 23 cm 9"
S/S Str.

¼

TCF4-595 14.5 cm 5 3/4"
TCF4-596 18 cm 7"
TCF4-597 20 cm 8"
TCF4-598 23 cm 9"
S/S Cvd.



**Metzenbaum-Fino
Operating Scissors
T/C Insert**

**Metzenbaum-Fino
Operating Scissors
T/C Insert**



¼

TCF4-599 14.5 cm 5 3/4"
TCF4-600 15.0 cm 6"
TCF4-601 17.0 cm 6 3/4"
TCF4-602 23.0 cm 9"
B/B, Str.

¼

TCF4-603 14.5 cm 5 3/4"
TCF4-604 15.0 cm 6"
TCF4-605 17.0 cm 6 3/4"
TCF4-606 23.0 cm 9"
B/B, Cvd.

¼

TCF4-607 15.0 cm 6"
TCF4-608 17.0 cm 6 3/4"
TCF4-609 19.5 cm 7 3/4"
TCF4-610 21.0 cm 8 3/4"
B/B, Str.

¼

TCF4-611 15.0 cm 6"
TCF4-612 17.0 cm 6 3/4"
TCF4-613 19.5 cm 7 3/4"
TCF4-614 21.0 cm 8 3/4"
B/B, Cvd.

**Mayo Dissecting &
Gynecological Scissors
T/C Insert**



**Mayo-stille Dissecting &
Gynecological Scissors
T/C Insert**

OPERATING SCISSORS T.C.



Chirurgische scheren
Tijeras quirúrgicas

Ciseaux chirurgicaux
Forbici per chirurgia

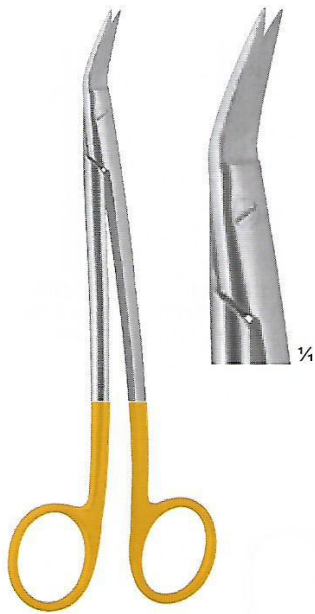

ENT-DEAN SCISSORS
TCF4-615 17 cm, 6 3/4"
S/S Double Cvd.
Serrated



TCF4-616
16.0 cm, 6 1/4"
TCF4-617
18.0 cm, 7"
S/S Str.

TCF4-618
16.0 cm, 6 1/4"
TCF4-619
18.0 cm, 7"
S/S Cvd.



1/4
TCF4-620
13 cm 5"
S/S Str.

1/4
TCF4-621
13 cm 5"
S/S Cvd.

Goldmann-Fox
Operating Scissors
T/C Insert



WIRE CUTTING SCISSORS
TCF4-622 12 cm, 4 3/4"

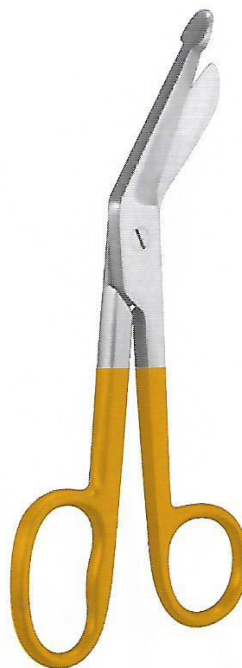

Lister Bandage Plaster
Scissors T/C Insert, one large ring
TCF4-623 8.9cm, 3 1/2"
TCF4-624 11.43 cm, 4.5"
TCF4-625 14 cm, 5 1/2"
TCF4-626 16 cm, 6 1/4"
TCF4-627 18 cm, 7"
TCF4-628 20 cm, 8"

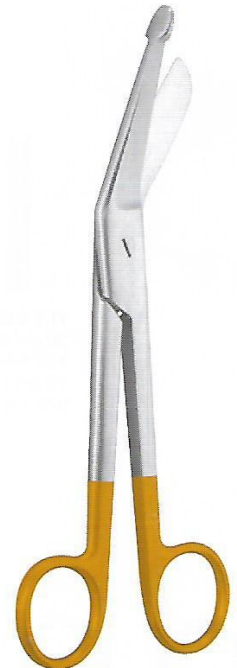

Lister Bandage Plaster
Scissors, T/C Insert
TCF4-629 8.9cm, 3 1/2"
TCF4-630 11.43 cm, 4.5"
TCF4-631 14 cm, 5 1/2"
TCF4-632 16 cm, 6 1/4"
TCF4-633 18 cm, 7"
TCF4-634 20 cm, 8"



OPERATING SCISSORS T.C.

Chirurgische scheren
Tijeras quirúrgicas

Ciseaux chirurgicaux
Forbici per chirurgia

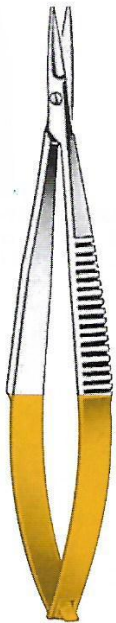

**Castroviejo Scissors
T/C Insert**



TCF4-635
14 cm, 5 1/2"
B/B Str.

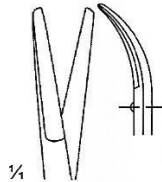

TCF4-636
14 cm, 5 1/2"
B/B Cvd.



TCF4-637
14 cm, 5 1/2"
S/B Str.

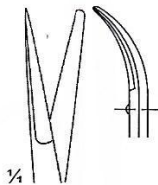

TCF4-638
14 cm, 5 1/2"
S/B Cvd.



TCF4-639
14 cm, 5 1/2"
S/S Str.

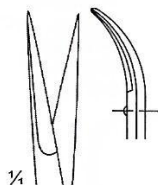

TCF4-640
14 cm, 5 1/2"
S/S Cvd.



**Joseph Operating
Scissors T/C Insert**



TCF4-641
14 cm 5 1/4"
S/S Str.



TCF4-642
14 cm 5 1/4"
S/S Cvd.



**Reynolds Operating
Scissors T/C Insert**



TCF4-643
16 cm 6 1/4"
TCF4-644
18 cm 7"
S/S Str.



TCF4-645
16 cm 6 1/4"
TCF4-646
18 cm 7"
S/S Cvd.

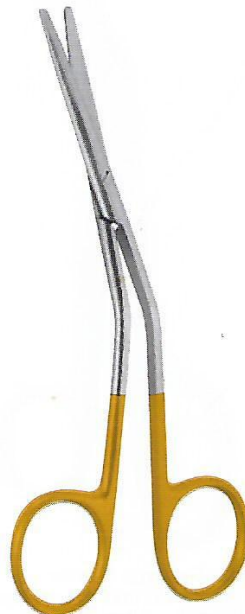

**Foman Operating
Scissors T/C Insert
TCF4-647**
13 cm 5" Full Bent



TCF4-648
10 cm 4"
TCF4-649
11 cm 4 1/4"
Str.



TCF4-650
10 cm 4"
TCF4-651
11 cm 4 1/4"
Cvd.



**Stevens Operating
Scissors T/C Insert**



DRESSING & TISSUE FORCEPS

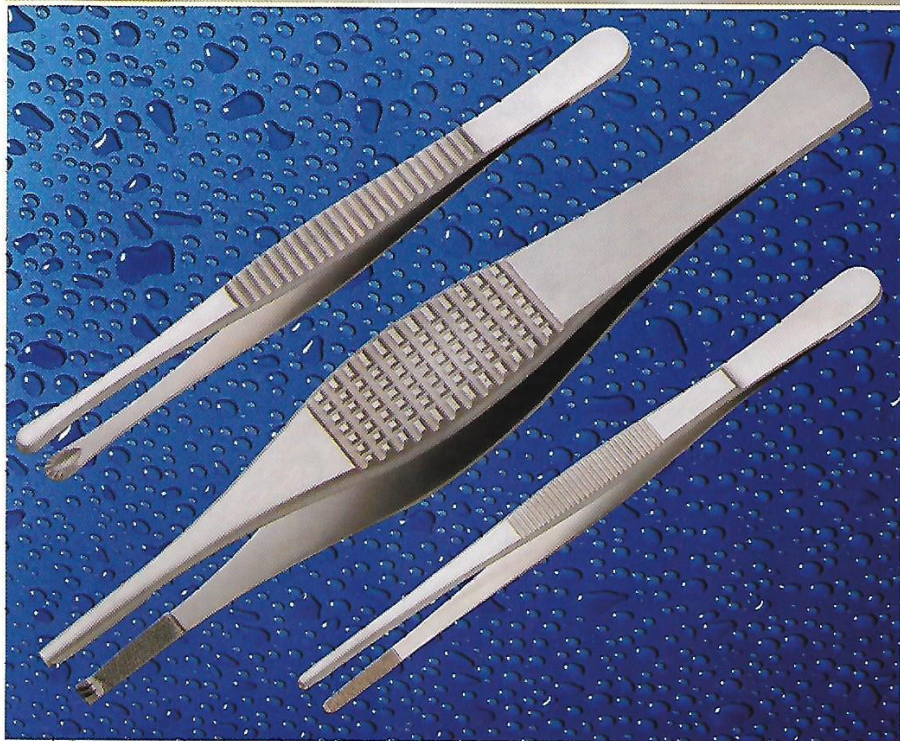
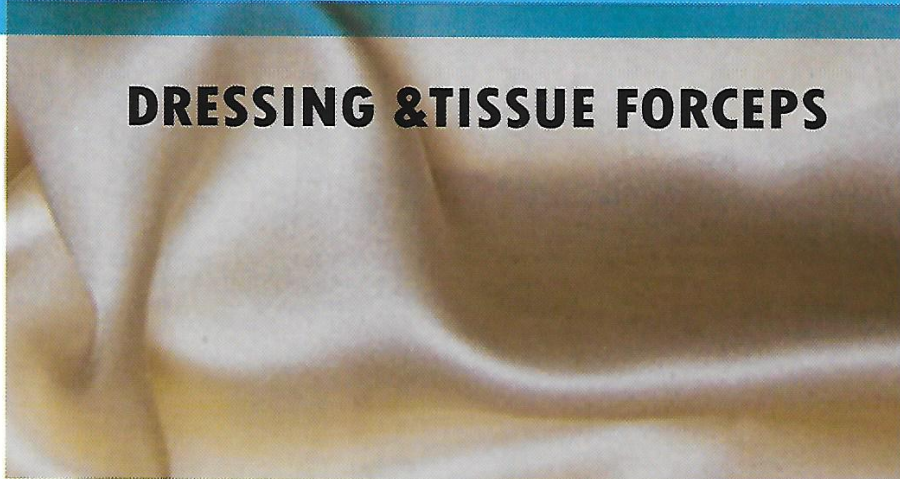



DRESSING FORCEPS, TISSUE FORCEPS

Anatomische pinzetten, chirurgische pinzetten

Pinces à dissection, pinces à griffes

Pinzas de disección, pinzas de disección condientes

Pinze Anatomiche per dissezion, pinze chirurgiche a dentiditopo

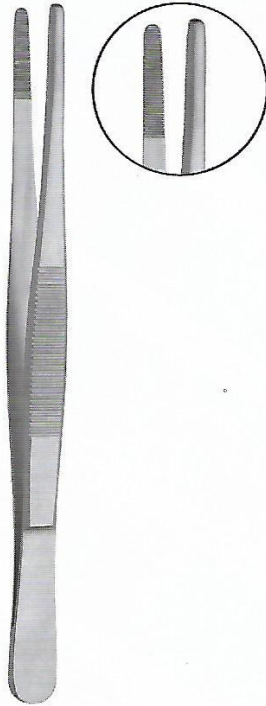

STANDARD
DRESSING
FORCEPS



F5-001
10.5 cm, 4 1/4"
serrated



F5-002
11.5 cm, 4 1/2"
serrated



F5-003
13 cm, 5"
serrated



F5-004
14.5 cm, 5 3/4"
serrated



F5-005
16 cm 6 1/4"
serrated



F5-006
18 cm, 7"
serrated

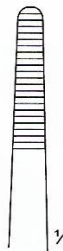

F5-007
20 cm, 8"
serrated



F5-008
25 cm, 10"
serrated



F5-009
30 cm, 12"
serrated

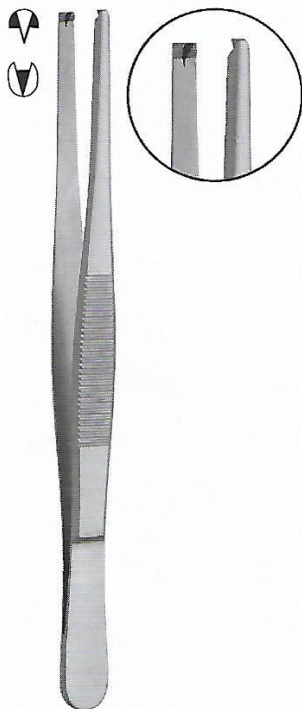

STANDARD TISSUE
FORCEPS 1x2 teeth



F5-010
10.5 cm, 4 1/4"



F5-011
11.5 cm, 4 1/2"



F5-012
13 cm, 5"



F5-013
14.5 cm, 5 3/4"



F5-014
16 cm 6 1/4"



F5-015
18 cm, 7"



F5-016
20 cm, 8"



F5-017
25 cm, 10"



F5-018
30 cm, 12"

TISSUE & DRESSING FORCEPS



Pinzas para tejidos, Pincas à dissection
Pinze per tessuti, Pinze per dissezione

Pincas a fissu, Anatomische pinzetten
Gewebe, Pinzas de disección

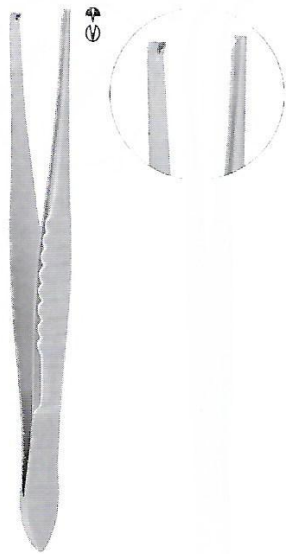

Mod. USA, Tissue Forceps
1x2 teeth

F5-019	10.2 cm, 4"
F5-020	11.4 cm, 4.5"
F5-021	12.7 cm, 5"
F5-022	14.0 cm, 5.5"
F5-023	15.2 cm, 6"
F5-024	17.8 cm, 7"
F5-025	20.3 cm, 8"
F5-026	25.4 cm, 10"
F5-027	30.5 cm, 12"

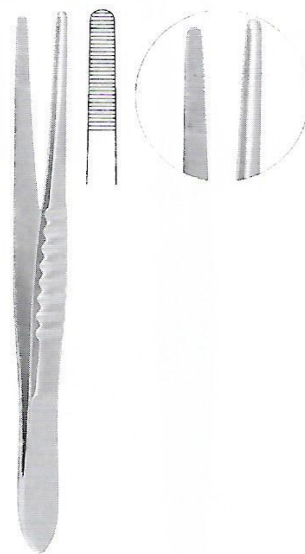

Mod. USA, Dressing Forceps serrated

F5-028	12 cm, 4 3/4"
F5-029	13 cm, 5"
F5-030	14.5 cm, 5 3/4"
F5-031	15.5 cm, 6"
F5-032	18 cm, 7"
F5-033	21 cm, 8 1/4"
F5-034	25 cm, 10"
F5-035	31 cm, 12 1/4"

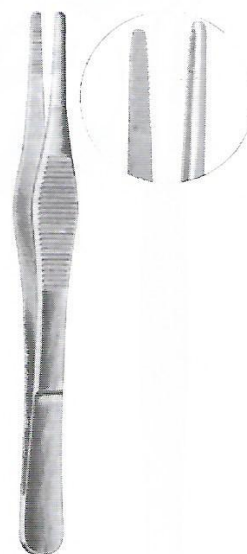

MOD. MARTIN Dressing Forceps

F5-036	12.7 cm, 5"
F5-037	14.0 cm, 5.5"

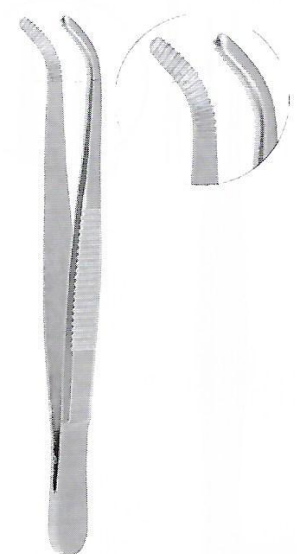

Standard Dressing Forceps

F5-038	11.4 cm, 4.5"
F5-039	12.7 cm, 5"
F5-040	14.0 cm, 5.5"
F5-041	15.2 cm, 6"
F5-042	17.8 cm, 7"
F5-043	20.3 cm, 8"
F5-044	25.4 cm, 10"
F5-045	30.5 cm, 12"

Curved, serrated

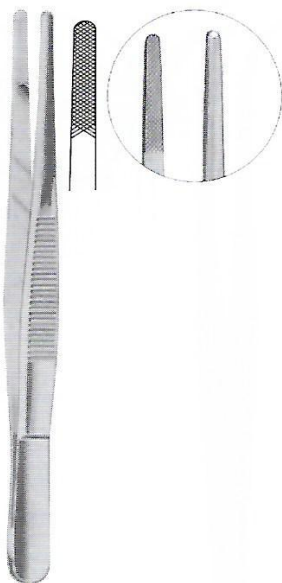

Standard Dressing Forceps wide pattern cross serration

F5-046	11.4 cm, 4.5"
F5-047	12.7 cm, 5"
F5-048	14.0 cm, 5.5"
F5-049	15.2 cm, 6"
F5-050	17.8 cm, 7"
F5-051	20.3 cm, 8"
F5-052	25.4 cm, 10"
F5-053	30.5 cm, 12"



Standard Dressing Forceps Narrow Point

F5-054	12.7 cm, 5"	serrated
F5-055	14 cm, 5.5"	serrated
F5-056	15.20 cm, 6"	serrated
F5-057	17.8 cm, 7"	serrated
F5-058	20.3 cm, 8"	serrated
F5-059	25.4 cm, 10"	serrated
F5-060	30.5 cm, 12"	serrated

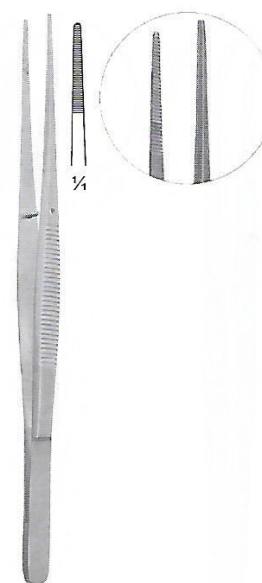

SEMKEN Dressing Forceps straight serrated

F5-061	12.5 cm, 5"
F5-062	15.5 cm, 6"

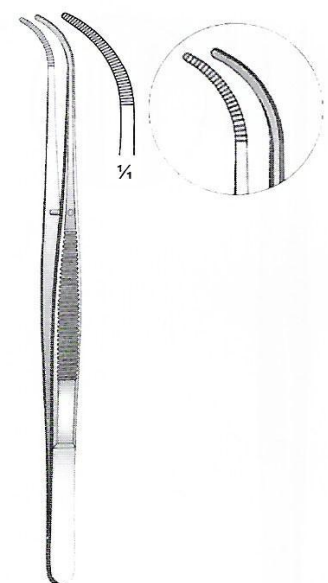

SEMKEN Dressing Forceps curved serrated

F5-063	12.5 cm, 5"
F5-064	15.5 cm, 6"



TISSUE & DRESSING FORCEPS

*Pincas a tissu, Anatomische pinzetten
Gewebe, Pinzas de disección*

*Pinzas para tejidos, Pincas à dissection
Pinze per tessuti, Pinze per dissezione*

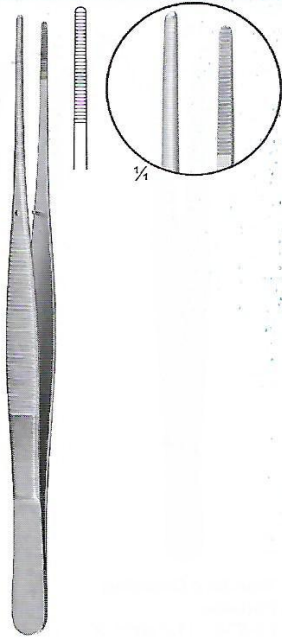

POTTS-SMITH Dressing Forceps
F5-065 17.5 cm, 7"
F5-066 21.0 cm, 8 1/4"
F5-067 25.0 cm, 10"
straight serrated

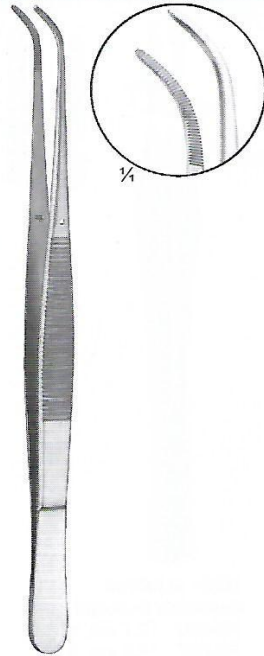

POTTS-SMITH Dressing Forceps
F5-068 17.5 cm, 7"
F5-069 21.0 cm, 8 1/4"
F5-070 25.0 cm, 10"
curved serrated



POTTS-SMITH Tissue Forceps 1x2 teeth
F5-071 17.5 cm, 7"
F5-072 21.0 cm, 8 1/4"
F5-073 25.0 cm, 10"
straight

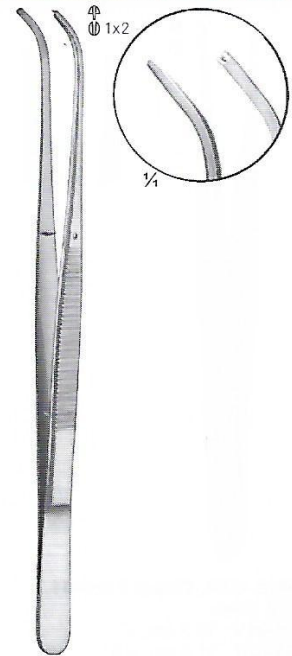

POTTS-SMITH Tissue Forceps 1x2 teeth
F5-074 17.5 cm, 7"
F5-075 21.0 cm, 8 1/4"
F5-076 25.0 cm, 10"
curved

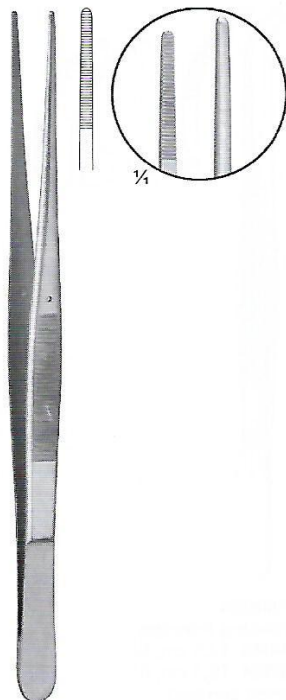

Brophy Dressing Forceps
F5-077 20.0 cm, 8"
straight serrated

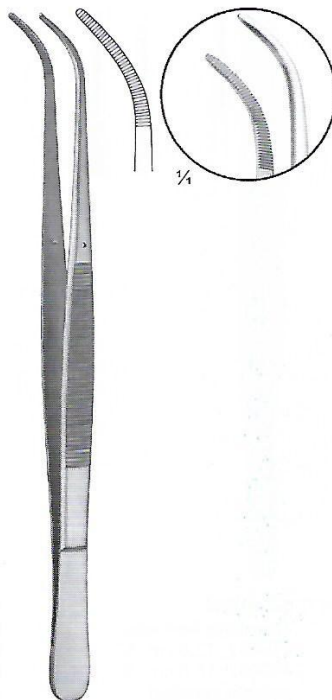

Brophy Dressing Forceps
F5-078 20.0 cm, 8"
curved serrated

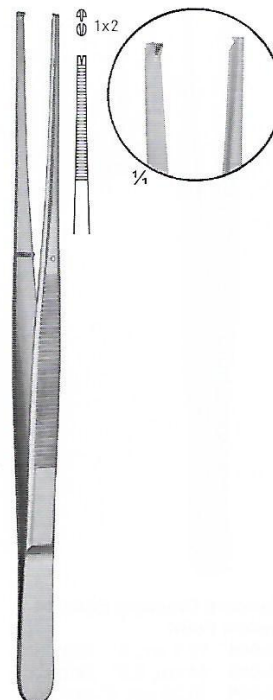

Brophy Tissue Forceps 1x2 teeth
F5-079 20.0 cm, 8"
straight serrated

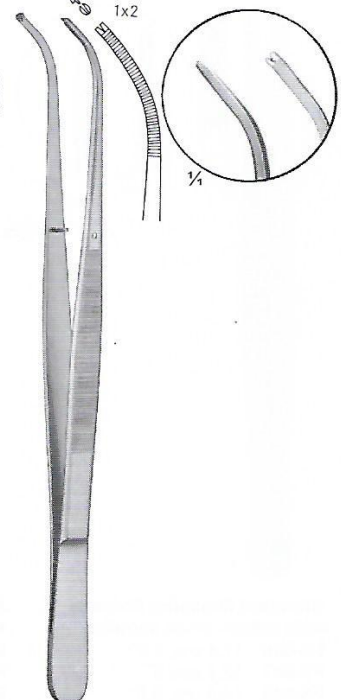

Brophy Tissue Forceps 1x2 teeth
F5-080 20.0 cm, 8"
curved serrated

TISSUE & DRESSING FORCEPS



Pinzas para tejidos, Pincas à dissection
Pinze per tessuti, Pinze per dissezione

Pincas a tissu, Anatomische pinzetten
Gewebe, Pinzas de disección

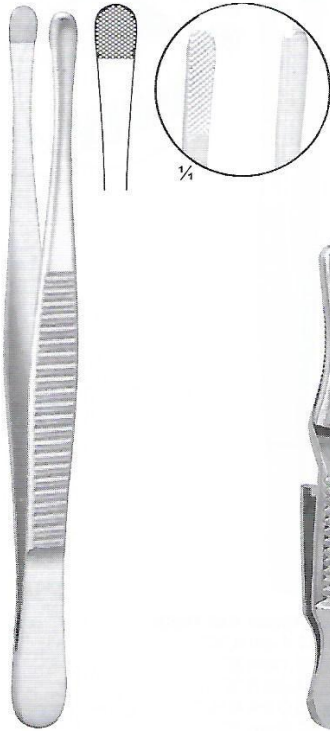

WANGENSTEEN Dressing Forceps
F5-081 23 cm, 9"



Bulldog Straight
F5-081A 4cm
F5-081B 5cm
F5-081C 6cm

Bulldog Curved
F5-081D 4cm
F5-081E 5cm
F5-081F 6cm



Bishop Forceps
F5-081G 8cm

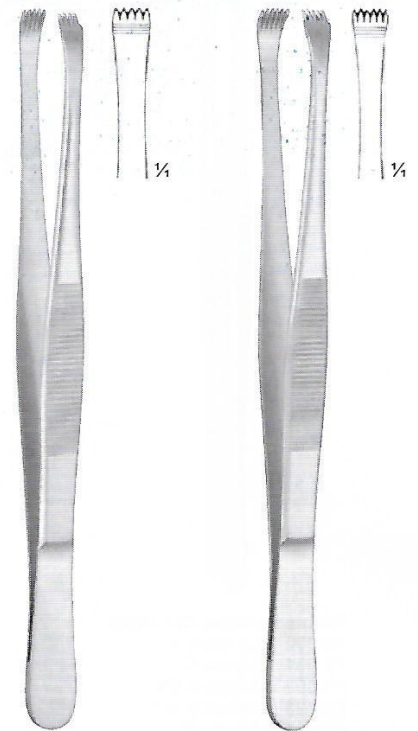

Stone Tissue Forceps
4X5 Teeth
F5-082 15.2 cm, 6"

Lerche Tissue Forceps
5X6 Teeth
F5-083 15 cm, 6"



Adlerkreutz Tissue Forceps
2X3 Teeth
F5-084 15 cm, 6"
F5-085 20 cm, 8"

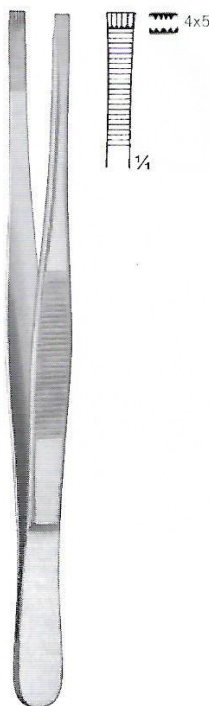

Adlerkreutz Tissue Forceps
4X5 Teeth
F5-086 15 cm, 6"
F5-087 20 cm, 8"

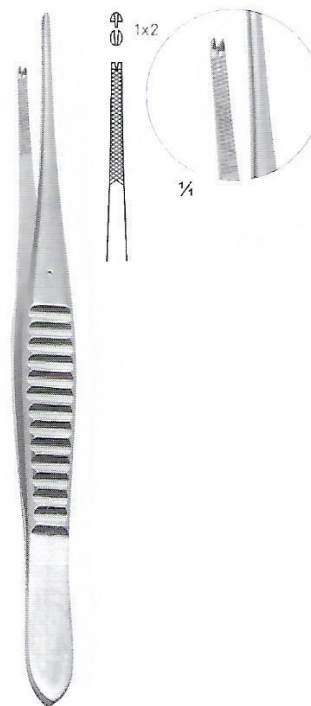

Gillies Tissue Forceps
1X2 Teeth
F5-088 15 cm, 6"
straight serrated



Gillies Tissue Forceps
1X2 Teeth
F5-089 15 cm, 6"
curved serrated



TISSUE & DRESSING FORCEPS

Pinzas para tejidos, Pincas à dissection
Pinze per tessuti, Pinze per dissezione

Pincas a tissu, Anatomische pinzetten
Gewebe, Pinzas de disección

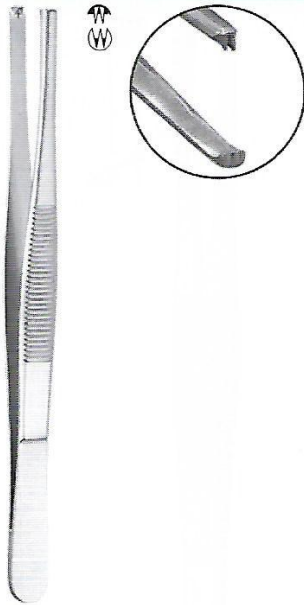

Tissue Forceps 2x3 Teeth
F5-090 11.4 cm 4 1/2"
F5-091 13.0 cm 5"
F5-092 14.5 cm 5 3/4"
F5-093 16.0 cm 6 1/4"
F5-094 17.5 cm 7"
F5-095 20.0 cm 8"
F5-096 25.0 cm 10"
F5-097 30.0 cm 12"

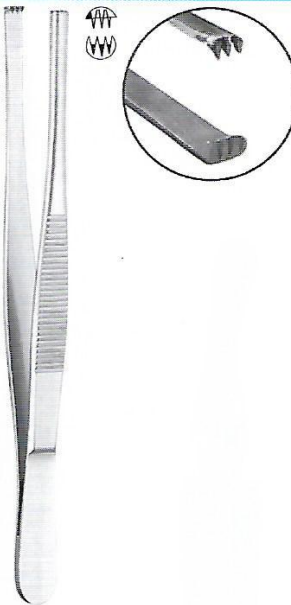

Tissue Forceps 3x4 Teeth
F5-098 11.4 cm 4 1/2"
F5-099 12.7 cm 5"
F5-100 14 cm 5 1/2"
F5-101 15.9 cm 6 1/4"
F5-102 17.8 cm 7"
F5-103 20.3 cm 8"
F5-104 25.4 cm 10"
F5-105 30.5 cm 12"

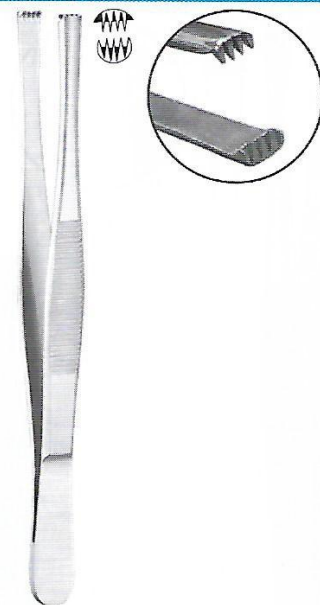

Tissue Forceps 4x5 Teeth
F5-106 11.4 cm 4 1/2"
F5-107 12.7 cm 5"
F5-108 14 cm 5 1/2"
F5-109 15.9 cm 6 1/4"
F5-110 17.8 cm 7"
F5-111 20.3 cm 8"
F5-112 25.4 cm 10"
F5-113 30.5 cm 12"



Iris Tissue Forceps
F5-114 10.2 cm, 4"
1x2 Teeth, Straight



Iris Tissue Forceps
F5-115 10.2 cm, 4"
1x2 Teeth, Half Curved

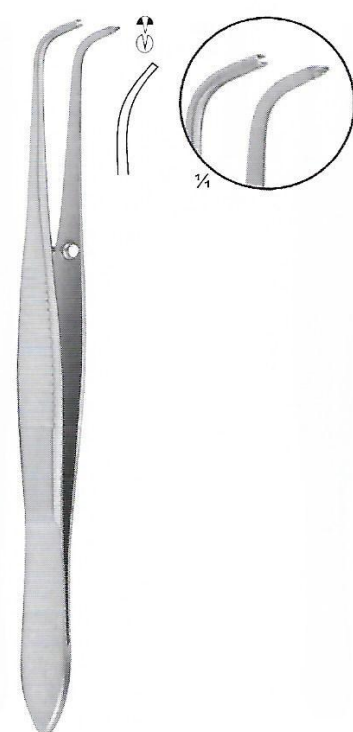

Iris Tissue Forceps
F5-116 10.2 cm, 4"
1x2 Teeth, Full Curved

TISSUE & DRESSING FORCEPS



Pinzas para tejidos, Pincas à dissection
Pinze per tessuti, Pinze per dissezione

Pincas a tissu, Anatomische pinzetten
Gewebe, Pinzas de disección



Waugh Dressing Forceps
F5-117 15.0 cm, 6"
F5-118 18.0 cm, 7"
slightly heavier
non-toothed,
serrated jaws.



Waugh Tissue Forceps
1x2 Teeth
F5-119 15.0 cm, 6"
F5-120 18.0 cm, 7"
as above but one two
tooth on serrated jaws.
Known as Scott.



Leedham Tissue Forceps
1x2 Teeth
F5-121 14.5 cm, 5.75"
F5-122 18.0 cm, 7"
Green Dissecting
Forceps two three
teeth, smooth jaws.

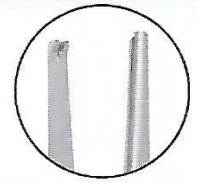

Treves Tissue Forceps
1x2 Teeth
F5-123 12.5 cm, 5"
F5-124 15.0 cm, 6"
F5-125 18.0 cm, 7"
Dissecting Forceps
teeth, on smooth jaws.



Charnley Tissue Forceps
1x2 Teeth
F5-126 14.5 cm, 5 3/4"
F5-127 18.0 cm, 7"
Dissecting Forceps
one into two teeth,
block on jaws.



Ramsay Dissecting Forceps
F5-128 18.0 cm, 7"
serrated jaws.



Ramsay Tissue Forceps
1x2 Teeth
F5-129 18.0 cm, 7"
Dissecting Forceps
one into teeth on
serrated jaws.



**Dissecting Dressing
Forceps**
F5-130 12.5 cm, 5"
F5-131 15.0 cm, 6"
F5-132 18.0 cm, 7"
turn over end,
serrated jaws.



**Dissecting Dressing
Forceps**
F5-133 12.5 cm, 5"
F5-134 15.0 cm, 6"
F5-135 18.0 cm, 7"
F5-136 20.0 cm, 8"
block end, serrated
jaws.



TISSUE & DRESSING FORCEPS

*Pinces a tissu, Anatomische pinzetten
Gewebe, Pinzas de disección*

*Pinzas para tejidos, Pinces à dissection
Pinze per tessuti, Pinze per dissezione*

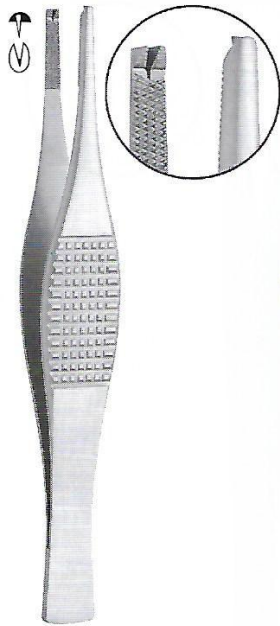

Ferris-Smith Tissue Forceps 1x2 Teeth
F5-137
18 cm, 7"

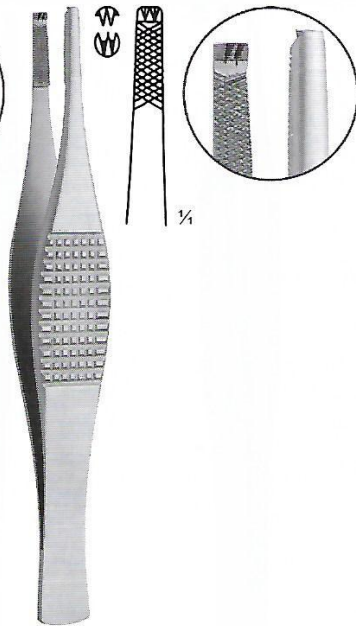

Ferris-Smith Tissue Forceps 2x3 Teeth
F5-138
18 cm, 7"

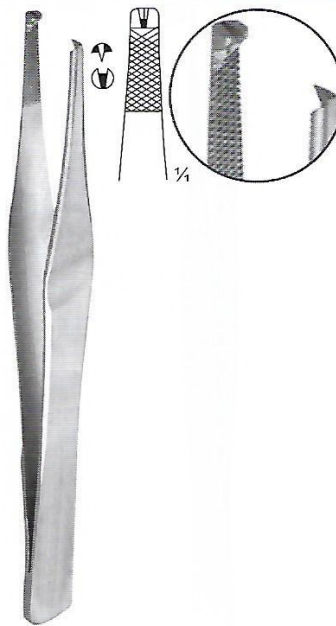

Lane Tissue Forceps 1x2 Teeth
F5-139 12.5cm, 5 1/2"
F5-140 15 cm, 6"
F5-141 17 cm, 6 3/4"
F5-142 18 cm, 7"
F5-143 20 cm, 8"

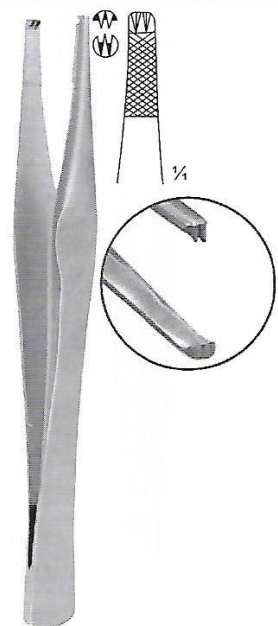

Lane Tissue Forceps 2x3 Teeth
F5-144 12.5cm, 5 1/2"
F5-145 15 cm, 6"
F5-146 17 cm, 6 3/4"
F5-147 18 cm, 7"
F5-148 20 cm, 8"

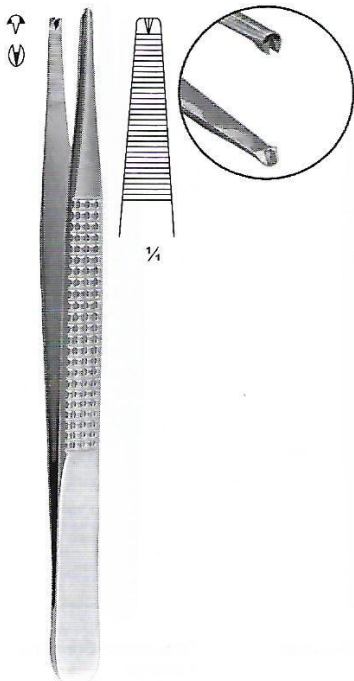

Bonney Tissue Forceps 1x2 Teeth
F5-149
18 cm, 7"

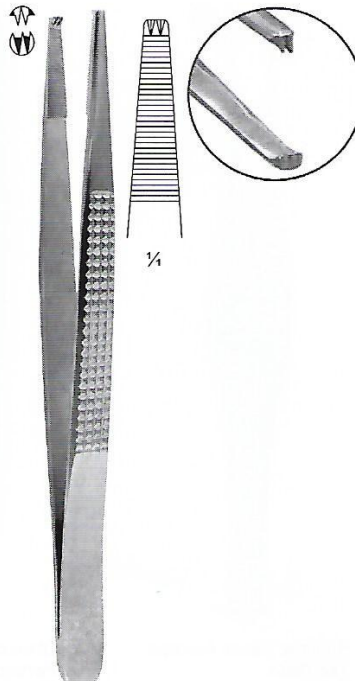

Bonney Tissue Forceps 2x3 Teeth
F5-150
18 cm, 7"



Durante Tissue Grasping Forceps
F5-151 14.5cm, 5 3/4"
F5-152 16 cm, 6 1/4"
F5-153 20 cm, 8"

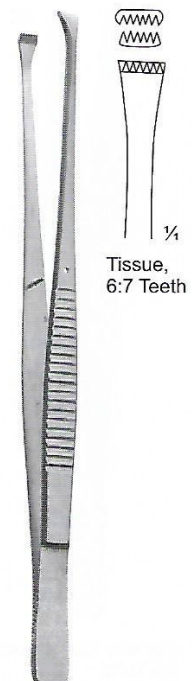

Nelson Tissue Forceps
F5-154 23 cm, 9"
6x7 Teeth

TISSUE & DRESSING FORCEPS



Pinzas para tejidos, Pincas à dissection
Pinze per tessuti, Pinze per dissezione

Pincas a tissu, Anatomische pinzetten
Gewebe, Pinzas de disección

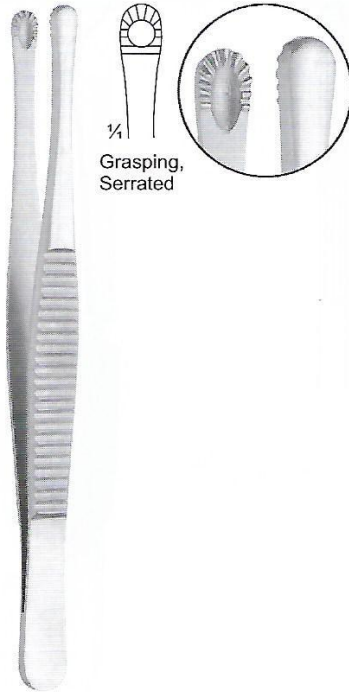

Grasping,
Serrated

**Russian-Modell
Tissue Forceps**
F5-155 15 cm, 6"
F5-156 20 cm, 8"
F5-157 25 cm, 10"



**Singley-Tuttle
Forceps**
F5-158
23 cm, 9"



**Collin-Duval
Forceps**

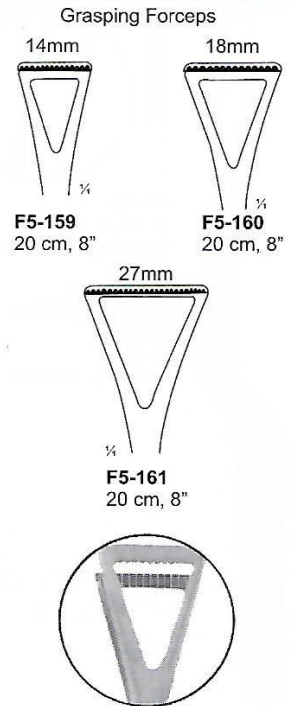

Grasping Forceps

14mm
F5-159
20 cm, 8"

18mm
F5-160
20 cm, 8"

27mm
F5-161
20 cm, 8"



**Stille-Barraya Tissue
Forceps 3x4 Teeth**
F5-162 18 cm, 7"
F5-163 20 cm, 8"
F5-164 25 cm, 10"



**Duehrssen Dressing
Forceps**
F5-165 20 cm, 8"
Serrated

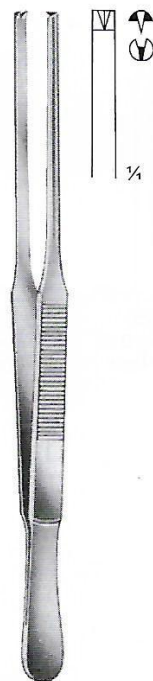

**Duehrssen Tissue
Forceps 1x2 Teeth**
F5-166
20 cm, 8"



**Duehrssen Tissue
Forceps 2x3 Teeth**
F5-167
20 cm, 8"



TISSUE & DRESSING FORCEPS

*Pinzas para tejidos, Pinces à dissection
Pinze per tessuti, Pinze per dissezione*

*Pinces a tissu, Anatomische pinzetten
Gewebe, Pinzas de disección*

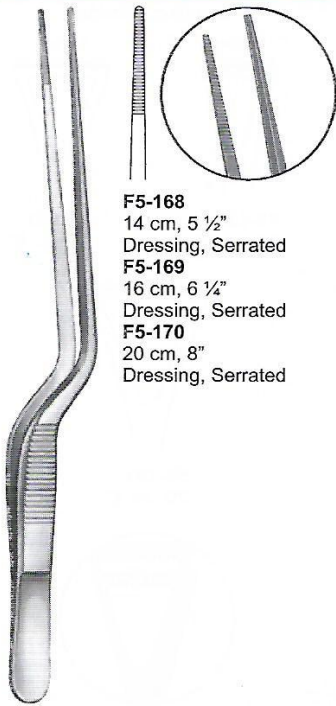

F5-168
14 cm, 5 1/2"
Dressing, Serrated
F5-169
16 cm, 6 1/4"
Dressing, Serrated
F5-170
20 cm, 8"
Dressing, Serrated

**LUCAE / ENT
Dressing Forceps**

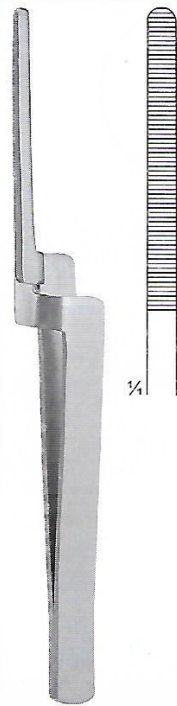

**Paper Dressing
Forceps
F5-171 15 cm, 6"**

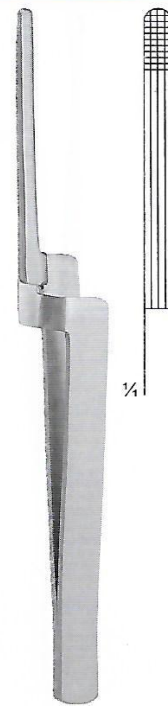

**Paper Dressing
Forceps
F5-172 15 cm, 6"**



**Paper Dressing
Forceps
F5-173 15 cm, 6"
Curved**

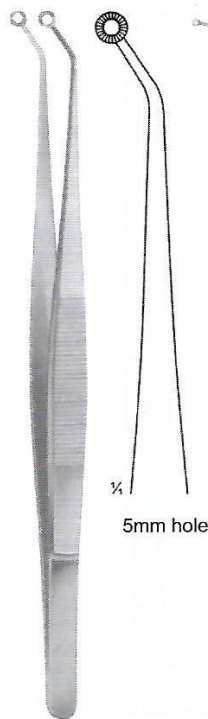

**Hunt Tumor and
Vessel Forceps
F5-174
20 cm, 8"**

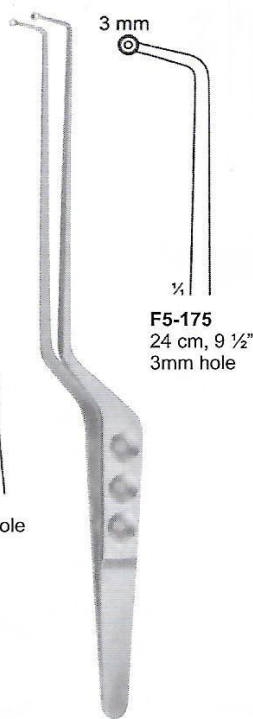

**Samii Forceps
Spoon-Shaped Jaws Left
24 cm, 9 1/2"**

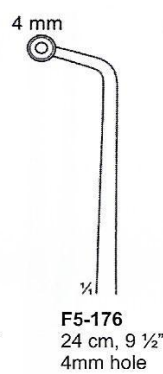

**F5-176
24 cm, 9 1/2"
4mm hole**

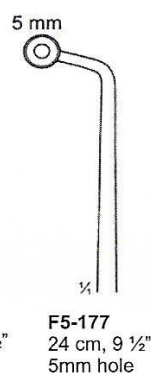

**F5-177
24 cm, 9 1/2"
5mm hole**



**F5-178
24 cm, 9 1/2"
3mm hole**

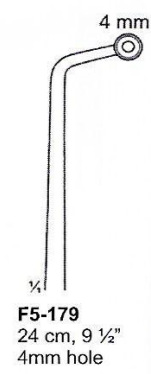

**F5-179
24 cm, 9 1/2"
4mm hole**

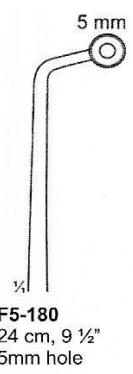

**F5-180
24 cm, 9 1/2"
5mm hole**

**Samii Forceps
Spoon-Shaped Jaws Right
24 cm, 9 1/2"**

TISSUE & DRESSING FORCEPS



Pinces a fissu, Anatomische pinzetten
Gewebe, Pinzas de disección

Pinzas para tejidos, Pinces à dissection
Pinze per tessuti, Pinze per dissezione



F5-181 regular point straight
F5-182 fine point straight
F5-183 mirco point straight
12 cm, 4 3/4" 1x2 Teeth



F5-184 regular point with platform straight
F5-185 fine point with platform straight
F5-186 mirco point with platform straight
12 cm, 4 3/4" 1x2 Teeth



F5-187 regular point curved
F5-188 fine point curved
F5-189 mirco point curved
12 cm, 4 3/4" 1x2 Teeth

F5-190 regular point straight
F5-191 fine point straight
F5-192 mirco point straight
12 cm, 4 3/4" 1x2 Teeth



F5-193 regular point, straight
F5-194 fine point, straight
Forceps, 12cm 4 3/4"
9x9 teeth

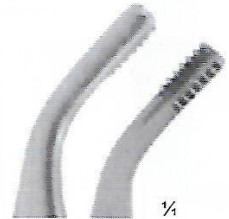

F5-195 regular point, Curved
F5-196 fine point, Curved
Forceps, 12cm 4 3/4"
9x9 teeth

Adson Tissue Forceps
Cuter Print

Adson Brown Tissue



F5-197 regular point straight
F5-198 fine point straight
F5-199 mirco point straight
12 cm, 4 3/4" 1x2 Teeth



F5-200 regular point with platform straight
F5-201 fine point with platform straight
F5-202 mirco point with platform straight
12 cm, 4 3/4" 1x2 Teeth



F5-203 regular point curved
F5-204 fine point curved
F5-205 mirco point curved
12 cm, 4 3/4" 1x2 Teeth

F5-206 regular point curved
F5-207 fine point curved
F5-208 mirco point curved
12 cm, 4 3/4" 1x2 Teeth

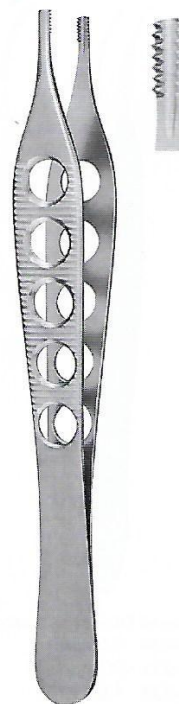
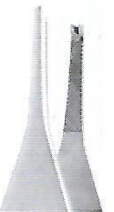

F5-209 regular point, straight
F5-210 fine point, straight
12cm 4 3/4"
7x7 teeth

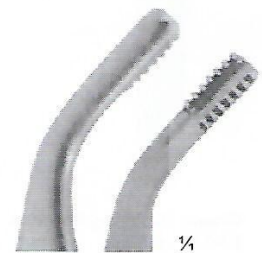
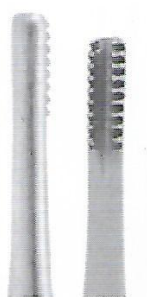

F5-211 regular point, Curved
F5-212 fine point, Curved
12cm 4 3/4"
7x7 teeth

Adson Tissue Forceps
with fenestrated handle

Adson Brown Tissue Forceps
Fenestrated Handle



TISSUE & DRESSING FORCEPS

Pincas a tissu, Anatomische pinzetten
Gewebe, Pinzas de disección

Pinzas para tejidos, Pincas à dissection
Pinze per tessuti, Pinze per dissezione

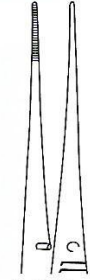

F5-213
7.0 cm, 2 3/4"
F5-214
10.0 cm, 4"
straight
serrated

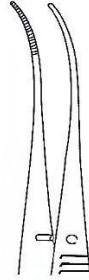

F5-215
7.0 cm, 2 3/4"
F5-216
10.0 cm, 4"
half curved
serrated

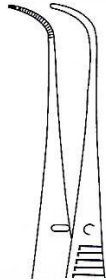

F5-217
7.0 cm, 2 3/4"
F5-218
10.0 cm, 4"
full curved
serrated



F5-225
11.0 cm, 4 1/2"
straight

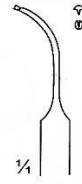

F5-226
11.0 cm, 4 1/2"
Curved

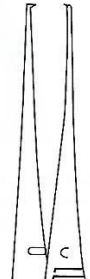

Graefe Forceps

F5-219 1x2 teeth
7.0 cm, 2 3/4"
F5-220 1x2 teeth
10.0 cm, 4"
straight

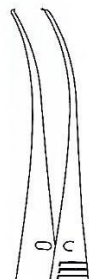

F5-221 1x2 teeth
7.0 cm, 2 3/4"
F5-222 1x2 teeth
10.0 cm, 4"
half curved

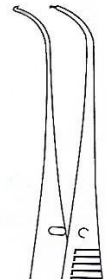

F5-223 1x2 teeth
7.0 cm, 2 3/4"
F5-224 1x2 teeth
10.0 cm, 4"
full curved

Stevens Tissue Forceps
1x2 Teeth

Stevens Tissue Forceps
1x2 Teeth



Graefe Dressing Forceps
F5-227 0.5 mm
F5-228 0.7 mm
F5-229 1.0 mm
7.0 cm, 3"
straight serrated

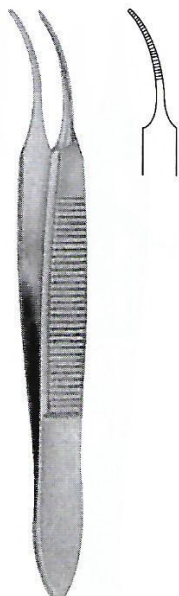

Graefe Dressing Forceps
F5-230 0.5 mm
F5-231 0.7 mm
F5-232 1.0 mm
7.0 cm, 3"
curved serrated



Graefe Tissue Forceps
1x2 Teeth
F5-233 0.5 mm
F5-234 0.7 mm
F5-235 1.0 mm
7.0 cm, 3"
straight



Graefe Tissue Forceps
1x2 Teeth
F5-236 0.5 mm
F5-237 0.7 mm
F5-238 1.0 mm
7.0 cm, 3"
curved



Graefe Fixation Forceps
F5-239
11.2 cm 4 3/8"
standard jaws 4.5mm wide
with fine teeth

JEWELER TYPE, DISSECTING FORCEPS



Chirurgische pinzetten, Uhrmacher-Pinzetten
Pinzas de disección con dientes, Pinzas de relojero

Pinces à dissection à grosses, Pinces d'horloger
Pinze per dissezione con denti, Pinze de orologiaio



Dumont Forceps
F5-240 11.5 cm, 4 ½"
curved



¼
F5-241
10.5 cm, 4"
full curved



F5-242
10.5 cm, 4"
half curved



F5-243
11 cm, 4 ½"



F5-244
11 cm, 4 ½"
fine point



¼
F5-245
11 cm, 4 ½"
extra fine point



F5-246
12 cm, 5"
fine point



F5-247
12 cm, 5"
extra fine point



F5-248
12 cm, 5"



Dumont Forceps
F5-249
style 1, fine point,
12.1 cm 4 ¾"



Dumont Forceps
F5-250
style 2, strong
fine point,
12.1 cm 4 ¾"



Dumont Forceps
F5-251
style 3, narrow
fine point,
12.1 cm 4 ¾"



Dumont Forceps
F5-252
style 3C, narrow
fine point,
11.2 cm 4 ¾"



JEWELER TYPE, DISSECTING FORCEPS

Chirurgische pinzetten, Uhrmacher-Pinzetten

Pinzas de disección con dientes, Pinzas de relojero

Pinces à dissection à grosses, Pinces d'horloger

Pinze per dissezione con denti, Pinze de orologiaio



**Dumont Forceps
F5-253**
style 4, fine point,
11.2cm 4 3/8"



**Dumont Forceps
F5-254**
style 5, super fine
11.2cm point, 4 3/8"



**Dumont Forceps
F5-255**
style 5, micro fine
11.2cm point, 4 3/8"



**Dumont Forceps
F5-256**
style 6, pick up,
11.4 cm 4 1/2"



**Dumont Forceps
F5-257**
style 7, fine curved,
11.4 cm 4 1/2"



**Dumont Forceps
F5-258**
style 7, micro fine
11.4 cm curved, 4 1/2"

CILIA FORCEPS



Cilienpinzetten
Pinzas depilatorias

Pinces à épiler les cils
Pinze depilatoria



Ziegler Cilia Forceps
F5-259
9 cm, 3 1/2"



Douglas Cilia Forceps
F5-260
9 cm, 3 1/2"



Beer Cilia Forceps
F5-261
9 cm, 3 1/2"

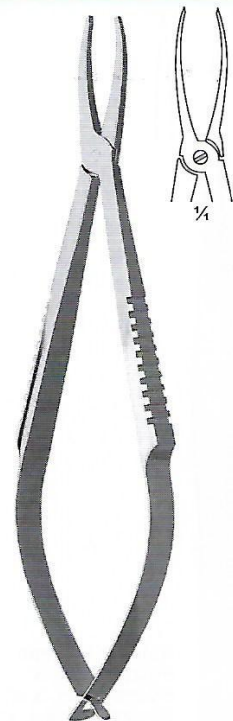

Gradle Cilia Forceps
F5-262
10.5cm, 4"



Kuehne Cilia Forceps
F5-263
10.5cm, 4"

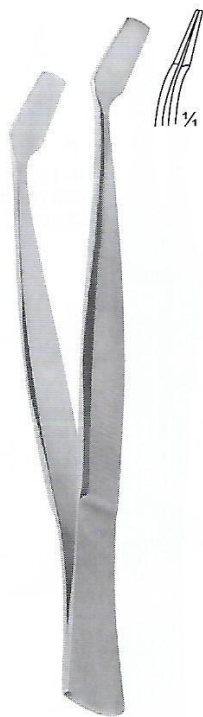

Kuehne Cilia Forceps
F5-264
10.5cm, 4"
angled sideways



Barraquer Cilia Forceps
F5-265
10.5cm, 4"



Littauer Cilia Forceps
F5-266
8.5 cm, 3"



Littauer Cilia Forceps
F5-267
9 cm, 3 1/2"



SPLINTER FORCEPS

Splitterpinzetten
Pinzas Para espinas

Pinces à échardes
Pinze per scheggie



Splinter Forceps
F5-268 8 cm, 3"
F5-269 9 cm, 3 1/2"
F5-270 10.5 cm, 4"
F5-271 11.5 cm, 4 1/2"
F5-272 12.5 cm, 5"
F5-273 14.5 cm, 5 1/2"
Straight Plain

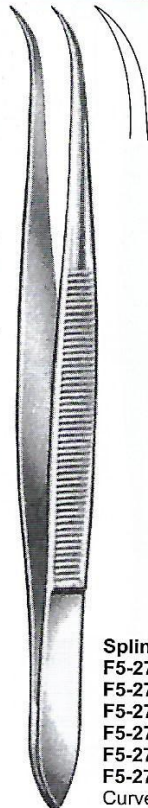

Splinter Forceps
F5-274 8 cm, 3"
F5-275 9 cm, 3 1/2"
F5-276 10.5 cm, 4"
F5-277 11.5 cm, 4 1/2"
F5-278 12.5 cm, 5"
F5-279 14.5 cm, 5 1/2"
Curved Plain



Splinter Forceps
F5-280 8 cm, 3"
F5-281 9 cm, 3 1/2"
F5-282 10.5 cm, 4"
F5-283 11.5 cm, 4 1/2"
F5-284 12.5 cm, 5"
F5-285 14.5 cm, 5 1/2"
Straight serrated

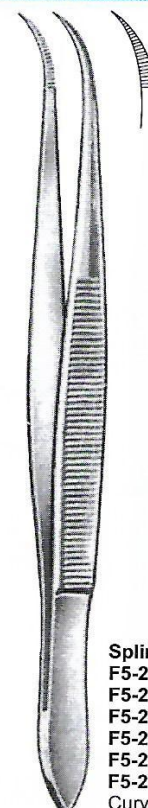

Splinter Forceps
F5-286 8 cm, 3"
F5-287 9 cm, 3 1/2"
F5-288 10.5 cm, 4"
F5-289 11.5 cm, 4 1/2"
F5-290 12.5 cm, 5"
F5-291 14.5 cm, 5 1/2"
Curved serrated



F5-292
7.5 cm, 3"
F5-293
9 cm, 3 1/2"
F5-294
11 cm, 4"
Straight



F5-295
10.5 cm, 4"
Straight



F5-296
10.5 cm, 4"
Curved



F5-297
10.5 cm, 4"
Straight



F5-298
10.5 cm, 4"
Curved

Feilchenfeld Forceps

Hunter Forceps

Hunter Forceps

Carmalt Forceps

Carmalt Forceps

SPLINTER FORCEPS



Splitterpinzetten
Pinzas Para espinas

Pinces à échardes
Pinze per scheggie



Splinter Forceps
F5-299 8.0 cm, 3"
F5-300 9.0 cm, 3 1/2"
F5-301 10.5 cm, 4"
F5-302 11.5 cm, 4 1/2"
F5-303 12.5 cm 5"
F5-304 14.5 cm 5 1/2"
Straight serrated with
guide pin



Splinter Forceps
F5-305 8.0 cm, 3"
F5-306 9.0 cm, 3 1/2"
F5-307 10.5 cm, 4"
F5-308 11.5 cm, 4 1/2"
F5-309 12.5 cm 5"
F5-310 14.5 cm 5 1/2"
Curved serrated with
guide pin



Splinter Forceps
F5-311 8.0 cm, 3"
F5-312 9.0 cm, 3 1/2"
F5-313 10.5 cm, 4"
F5-314 11.5 cm, 4 1/2"
F5-315 12.5 cm 5"
F5-316 14.5 cm 5 1/2"
Straight plain with
guide pin



Splinter Forceps
F5-317 8.0 cm, 3"
F5-318 9.0 cm, 3 1/2"
F5-319 10.5 cm, 4"
F5-320 11.5 cm, 4 1/2"
F5-321 12.5 cm 5"
F5-322 14.5 cm 5 1/2"
Curved plain with
guide pin

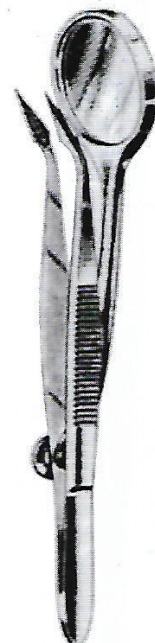

**Stieglitz Forceps
with Magnifying
Mirrors**
F5-323
12.5 cm, 5"

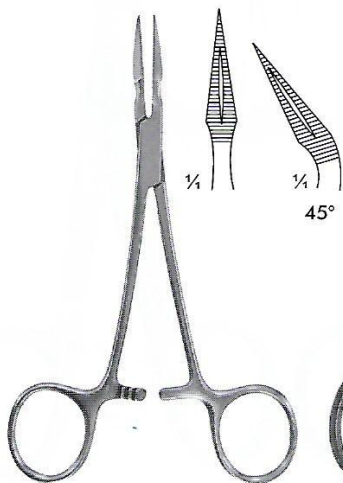

Stieglitz Splinter Forceps
F5-324 14 cm, 5 1/2" Str.
F5-325 14 cm, 5 1/2" 45° Angled

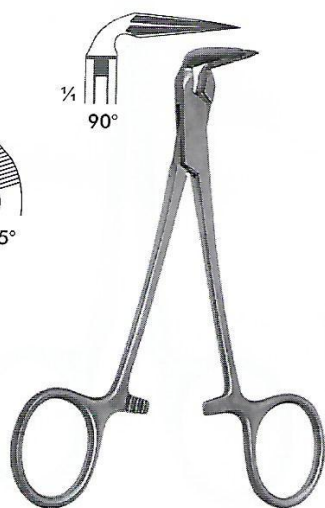

Stieglitz Splinter Forceps
F5-326
14 cm, 5 1/4" 90° Angled



Peet Splinter Forceps
F5-327
11.5 cm, 4 1/2"

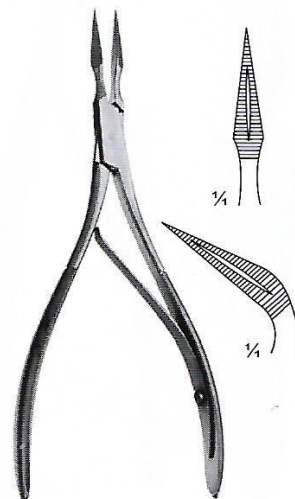

Ralk Splinter Forceps
F5-328 15 cm, 6" Str.
F5-329 15 cm, 6" Cvd.



GENERAL INSTRUMENTS

Allgemeines Instrumentarium
Instrumental general

Instrumentation générale
Strumentario generale



Ochsner Forceps
F5-330
14 cm, 5 1/2"



Lange Tissue Forceps
F5-331
10 cm, 4"

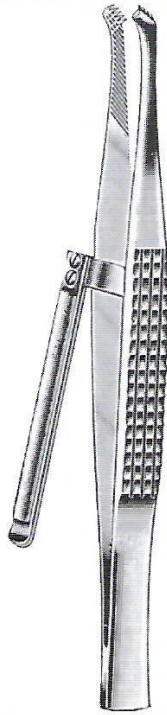

Childe Tissue Forceps
F5-332
18 cm, 7"



Michel Tissue Forceps
F5-333
12 cm, 4 3/4"



Wachenfeldt Tissue Forceps
F5-334
12.5 cm, 5"



HEGENBARTH Tissue Forceps
F5-335
12.5 cm, 5"



Wachenfeldt Tissue Forceps
F5-336
12.5 cm, 5"

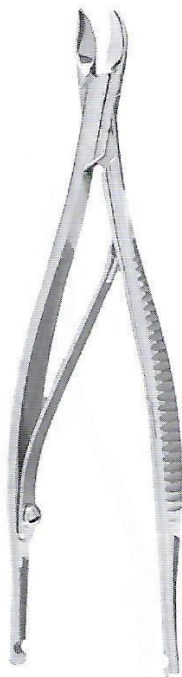

Michel Forceps
F5-337
12 cm, 4 3/4"



Michel Clips
F5-338
sizes: 11mm x 3mm
& 18mm x 3mm.

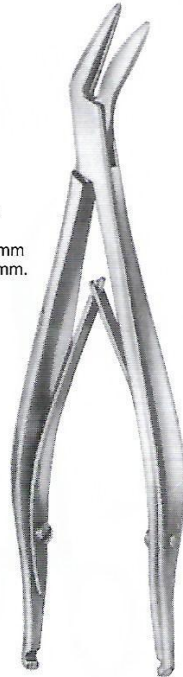

Mod. Michel Forceps
F5-339
12 cm, 4 3/4"

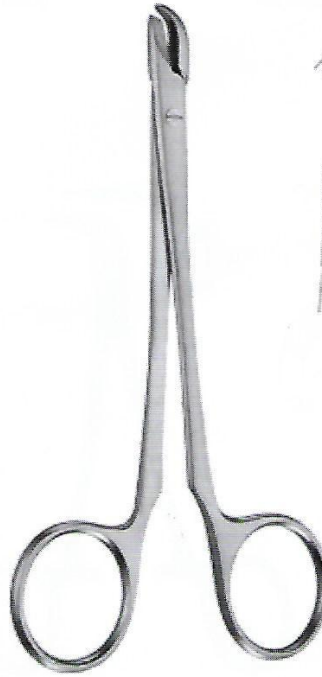

Collin Forceps
F5-340
13 cm, 5"

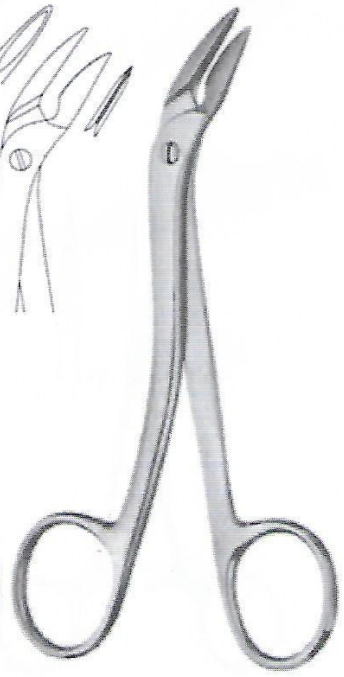

Richter-Heath Forceps
F5-341
14 cm, 5 1/2"

TISSUE & DRESSING FORCEPS T.C



Pinces a tissu, Anatomische pinzetten
Gewebe, Pinzas de disección

Pinzas para tejidos, Pincas à dissection
Pinze per fissuti, Pinze per dissezione

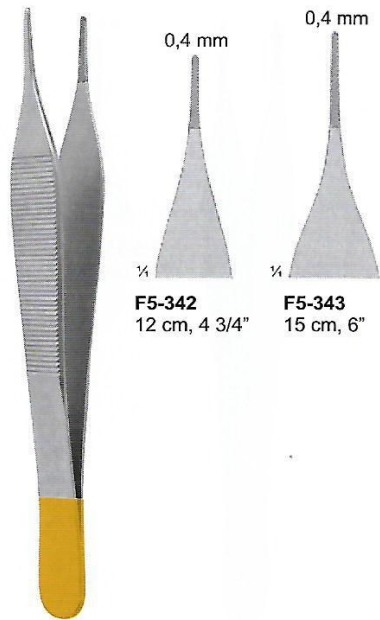

Micro Adson



Adson



Adson

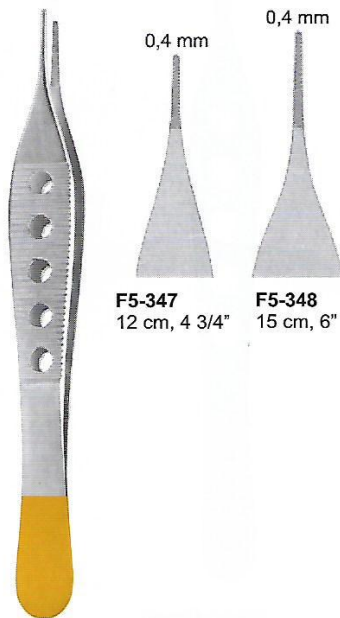

**Micro Adson
Light Weight**

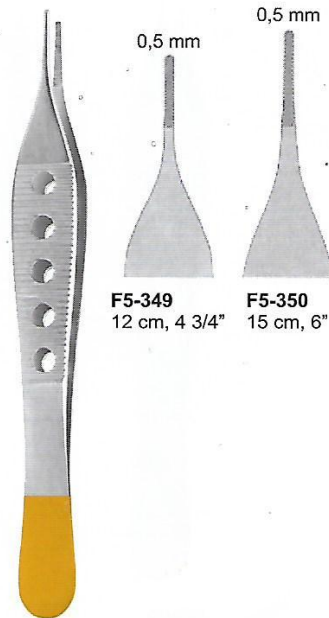

**Adson
Light Weight**

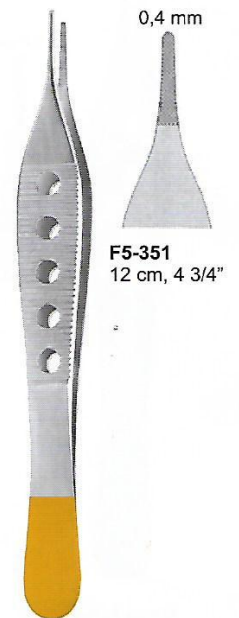

**Adson
Light Weight**



TISSUE & DRESSING FORCEPS T.C

*Pincas a tissu, Anatomische pinzetten
Gewebe, Pinzas de disección*

*Pinzas para tejidos, Pincas à dissection
Pinze per tessuti, Pinze per dissezione*

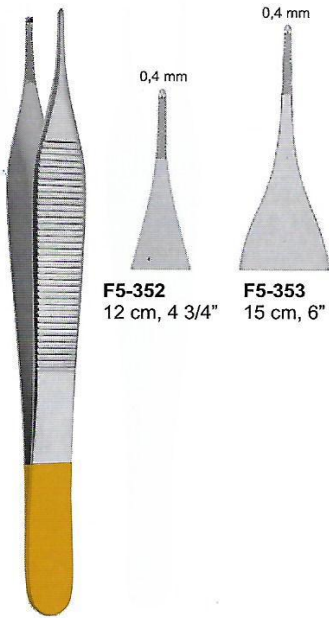

F5-352
12 cm, 4 3/4"

F5-353
15 cm, 6"

Micro Adson Tissue Forceps
1x2 teeth

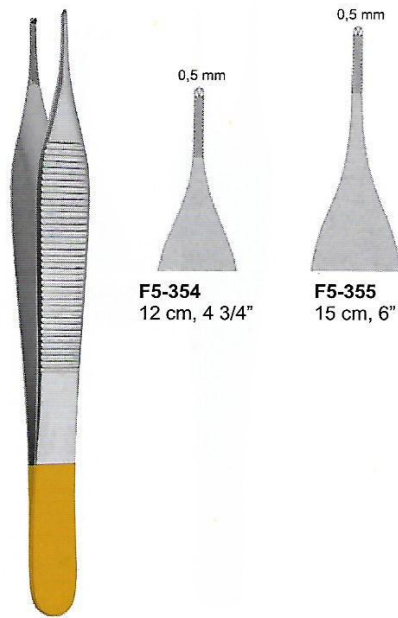

F5-354
12 cm, 4 3/4"

F5-355
15 cm, 6"

Adson Tissue Forceps
1x2 teeth



F5-356
12 cm, 4 3/4"

Adson Tissue Forceps
3x4 teeth

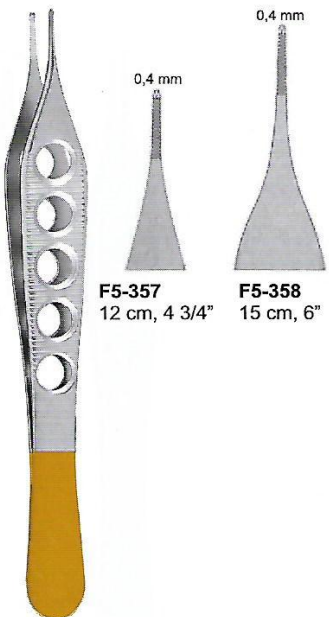

F5-357
12 cm, 4 3/4"

F5-358
15 cm, 6"

Micro Adson Light Weight
1x2 teeth



F5-359
12 cm, 4 3/4"

F5-360
15 cm, 6"

Adson Light Weight
1x2 teeth

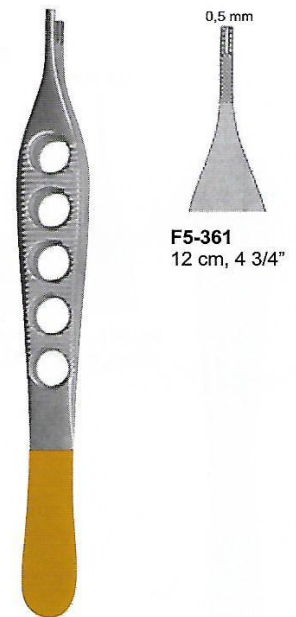

F5-361
12 cm, 4 3/4"

Adson-Brown Light Weight
3x4 teeth

TISSUE & DRESSING FORCEPS T.C



Pinces a tissu, Anatomische pinzetten
Gewebe, Pinzas de disección

Pinzas para tejidos, Pinces à dissection
Pinze per tessuti, Pinze per dissezione

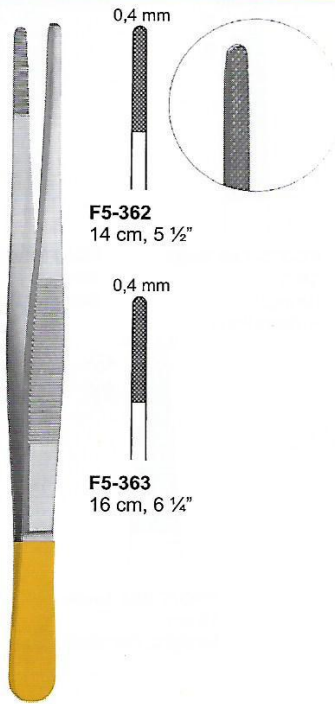

T.C Standard Dressing Forceps



T.C Cushing Tissue Forceps
 F5-364 17.8 cm, 7"



T.C Cushing Dressing Forceps
 F5-365
 18 cm, 7" Cross Serrated

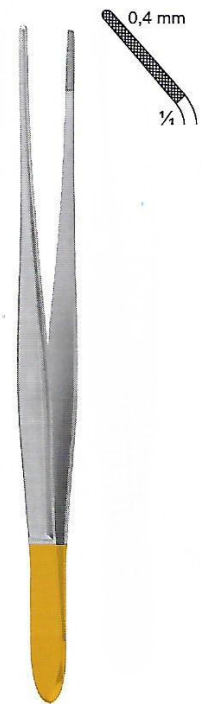

T.C Cushing Dressing Forceps
 F5-366 18 cm, 7"



T.C Dissecting Tissue Forceps
 F5-367 18 cm, 7"



T.C Resano Dressing Forceps
 F5-368
 25 cm, 10"

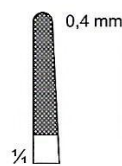

T.C Cushing Dressing Forceps
 F5-369
 19 cm, 7 1/2"



TISSUE & DRESSING FORCEPS T.C

*Pinces a tissu, Anatomische pinzetten
Gewebe, Pinzas de disección*

*Pinzas para tejidos, Pinces à dissection
Pinze per tessuti, Pinze per dissezione*

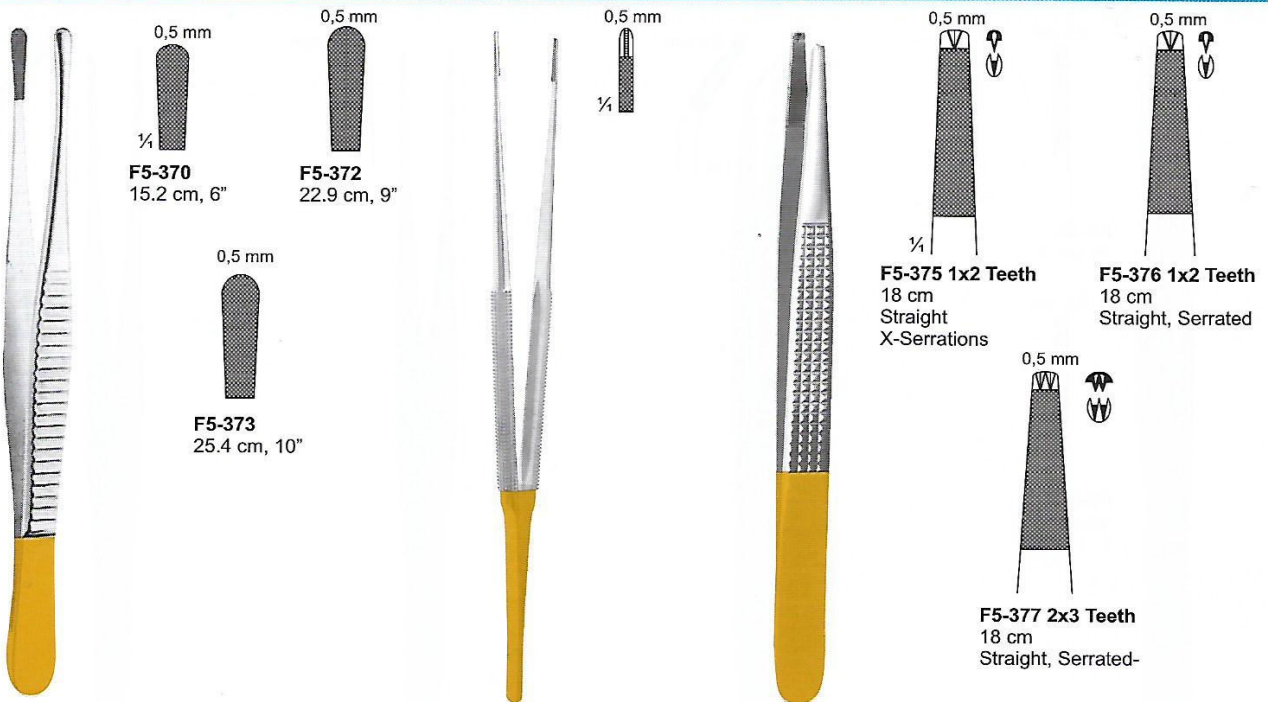

Wangenstein Dressing Forceps T.C.

T.C DeBakey Micro Needle Tissue Forceps F5-374
18.4 cm, 7"

T.C Bonney Dissecting & Tissue Forceps



T.C POTTS-SMITH Dressing Forceps
F5-378 15 cm, 6"
F5-379 18 cm, 7"
F5-380 20 cm, 8"
F5-381 23 cm, 9"
F5-382 25 cm, 10"



T.C POTTS-SMITH Dressing Forceps
F5-383 16 cm, 6 ½"
F5-384 18 cm, 7"
F5-385 21 cm, 8 ½"
F5-386 24 cm, 9 ½"
F5-387 26 cm, 10 ½"



T.C Evans Pelvic Needle Dressing Forceps F5-388
25.4 cm, 10"

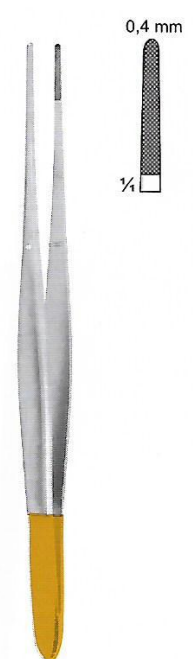

T.C Evans Dressing Forceps F5-389
25 cm, 10"

DRESSING FORCEPS T.C.



Anatomische pinzetten
Pinzas de disección

Pinces à dissection
Pinze per dissezione



T.C. Mc Indoe Dressing Forceps
F5-390
15.0 cm 6"

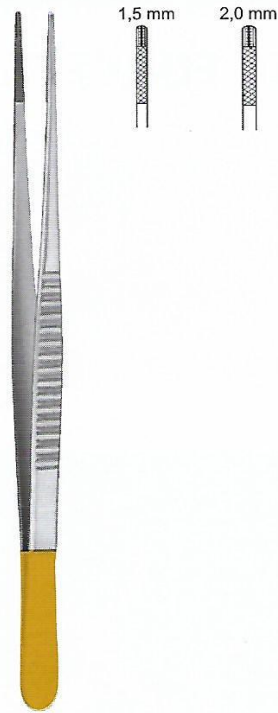

T.C. De Bakay Dressing Forceps
F5-391 15.0 cm 6"
F5-392 19.0 cm 7 1/2"
F5-393 24.0 cm 9 1/2"



T.C. Gillies Tissue Forceps
F5-394
15.0 cm 6"



SEMKEN
with dissector end

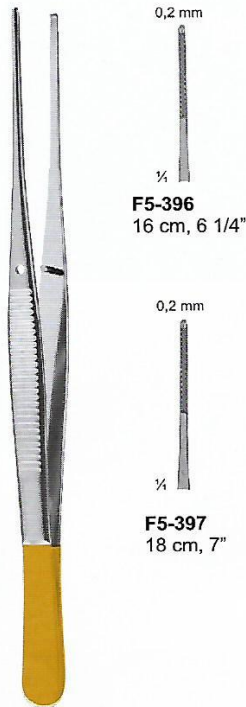

SEMKEN
1x2 teeth

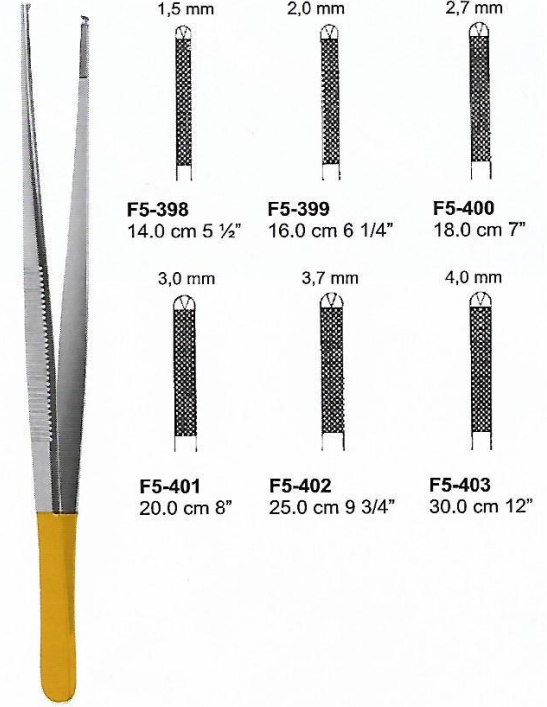

T.C. Oehler Tissue Forceps



HAEMOSTATIC FORCEPS

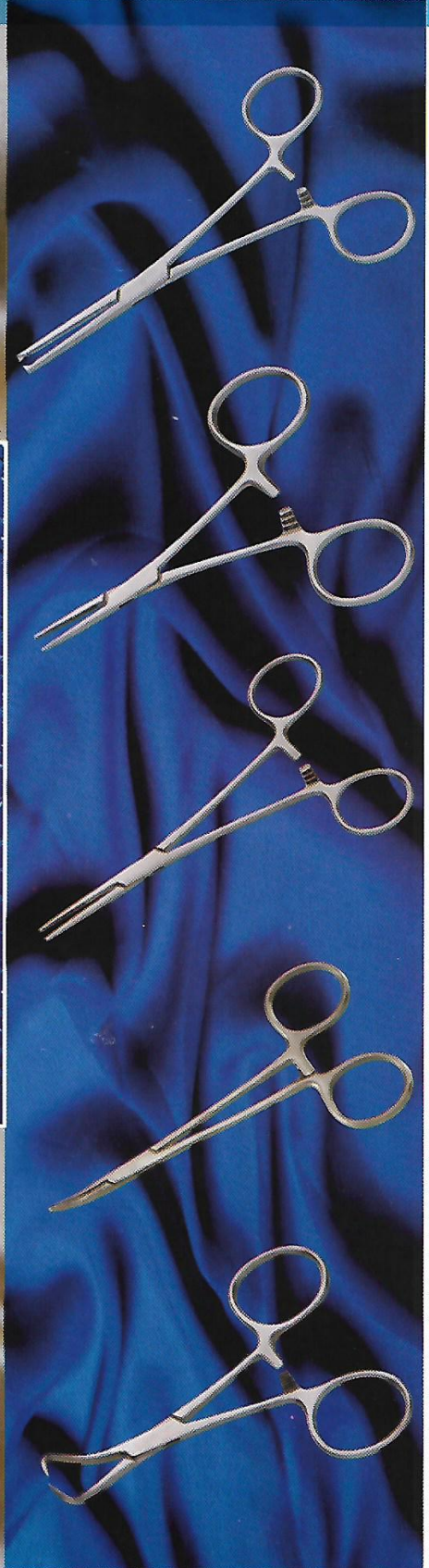
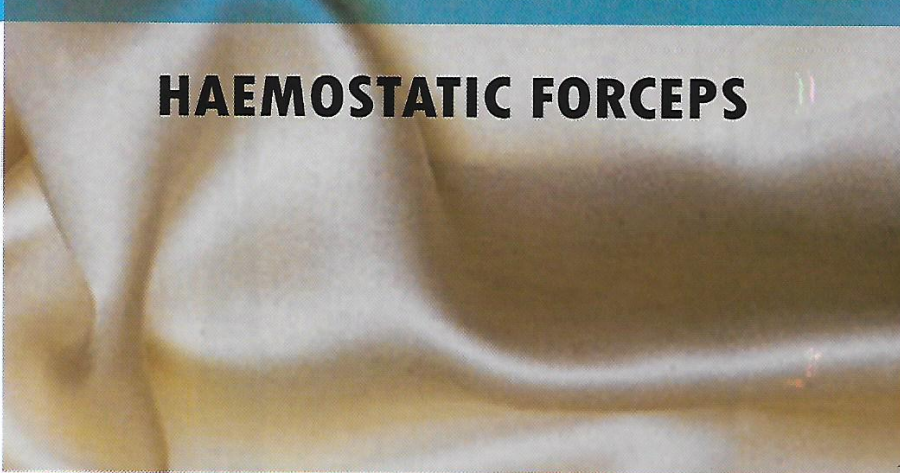

HAEMOSTATIC FORCEPS



Arterienklemmen
Pincas Hemostatiques

Pinzas Hemostaticas
Pinze Emostatiche



F6-001
11.3 cm, 4 1/2"
straight, serrated



F6-002
11.3 cm, 4 1/2",
curved, serrated



F6-003
11.3 cm, 4 1/2", straight
Haemostatic tissue
(rat tooth 1x2 teeth)



F6-004
11.3 cm, 4 1/2", curved
Haemostatic tissue
(rat tooth 1x2 teeth)



Mosquito Haemostatic Forceps



F6-005 12.5 cm, 5"
F6-006 20 cm, 8"
straight



F6-007 12.5 cm, 5"
F6-008 20 cm, 8"
curved



F6-009 12.5 cm, 5"
F6-010 20 cm, 8"
straight Left Handed



F6-011 12.5 cm, 5"
F6-012 20 cm, 8"
curved Left Handed



Halsted-Mosquito
Haemostatic Forceps

Halsted-Mosquito
Haemostatic Forceps



HAEMOSTATIC FORCEPS

Arterienklemmen
Pinces Hemostatiques

Pinzas Hemostaticas
Pinze Emostatiche

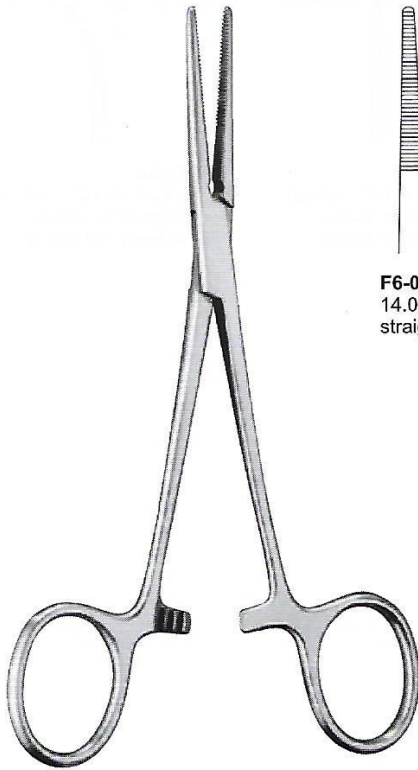

Kelly Haemostatic Forceps



F6-013
14.0 cm, 5 1/2"
straight



F6-014
14.0 cm, 5 1/2"
curved



F6-015
Kelly Haemostatic Fine
point Forceps 14.0 cm
5 1/2", straight



F6-016
Kelly Haemostatic Fine
point Forceps 14.0 cm
5 1/2", curved

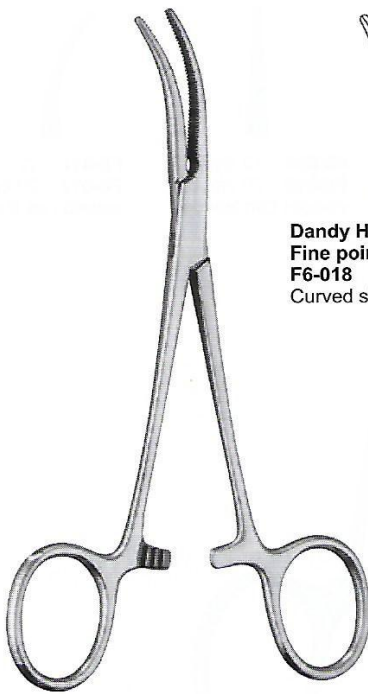

Dandy Haemostatic Forceps
F6-017 14.0 cm, 5 1/2"
Curved sideways



**Dandy Haemostatic
Fine point Forceps**
F6-018 14.0 cm, 5 1/2"
Curved sideways

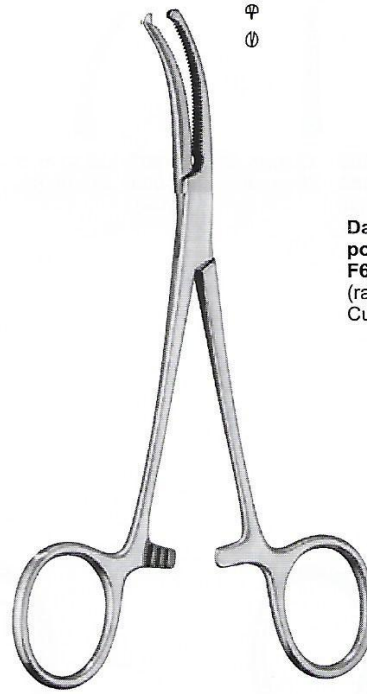

**Dandy Haemostatic
Tissue Forceps**
F6-019 14.0 cm, 5 1/2"
(rat tooth 1x2 teeth)
Curved sideways



**Dandy Haemostatic Fine
point Tissue Forceps**
F6-020 14.0 cm, 5 1/2"
(rat tooth 1x2 teeth)
Curved sideways

HAEMOSTATIC FORCEPS



Arterienklemmen
Pinces Hemostatiques

Pinzas Hemostaticas
Pinze Emostatiche

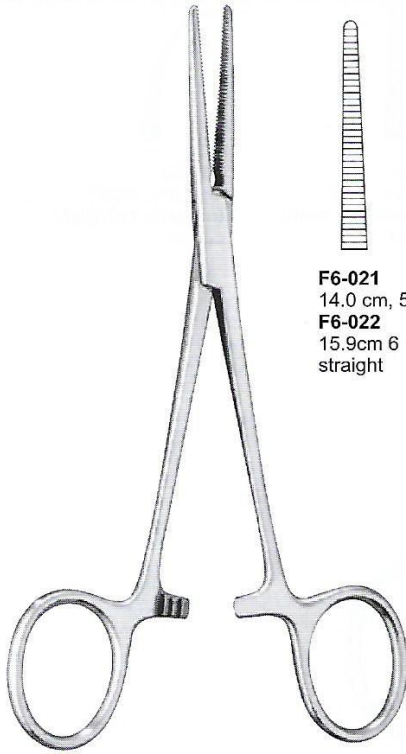

Crile Haemostatic Forceps



F6-021
14.0 cm, 5 1/2"
F6-022
15.9cm 6 1/4"
straight



F6-023
14.0 cm, 5 1/2"
F6-024
15.9cm 6 1/4"
curved

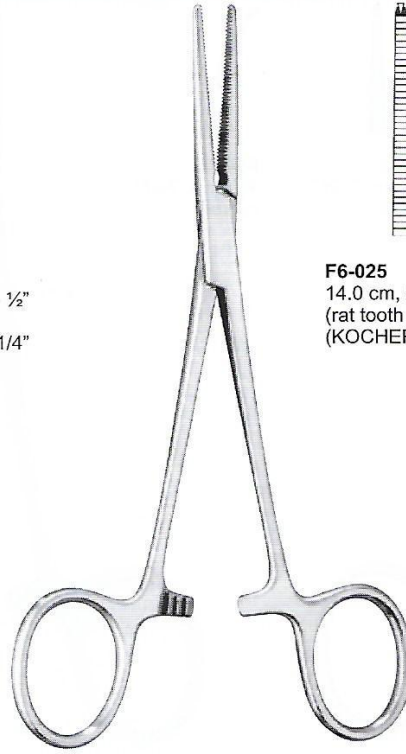

Crile Haemostatic
Tissue Forceps



F6-025
14.0 cm, 5 1/2"
(rat tooth 1x2 teeth)
(KOCHER) straight



F6-026
14.0 cm, 5 1/2"
(rat tooth 1x2 teeth)
(KOCHER) curved

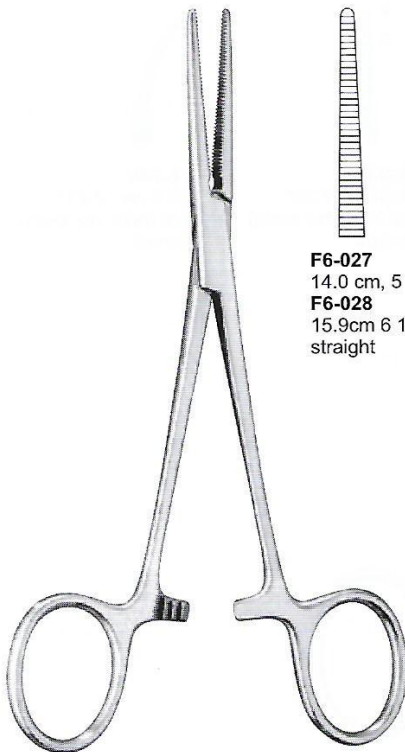

Crile Haemostatic
Fine Point Forceps



F6-027
14.0 cm, 5 1/2"
F6-028
15.9cm 6 1/4"
straight



F6-029
14.0 cm, 5 1/2"
F6-030
15.9cm 6 1/4"
curved

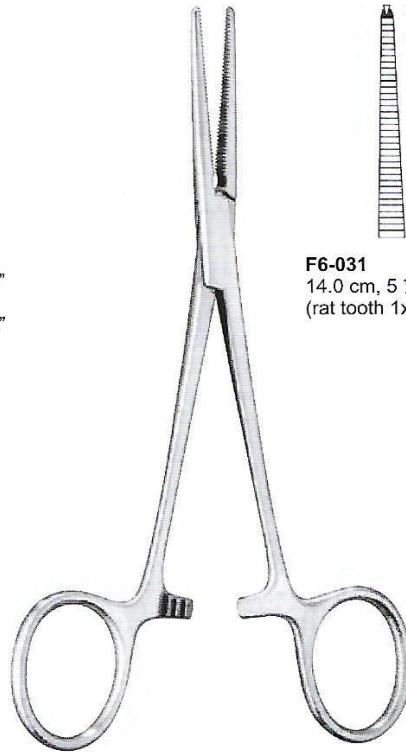

Crile Haemostatic Fine
Point Tissue Forceps



F6-031
14.0 cm, 5 1/2" straight
(rat tooth 1x2 teeth)

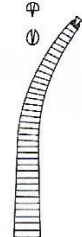

F6-032
14.0 cm, 5 1/2" curved
(rat tooth 1x2 teeth)



HAEMOSTATIC FORCEPS

Arterienklemmen
Pinces Hemostatiques

Pinzas Hemostaticas
Pinze Emostatiche



F6-033
18.5 cm, 7.25"
straight



F6-034
18.5 cm, 7.25"
curved

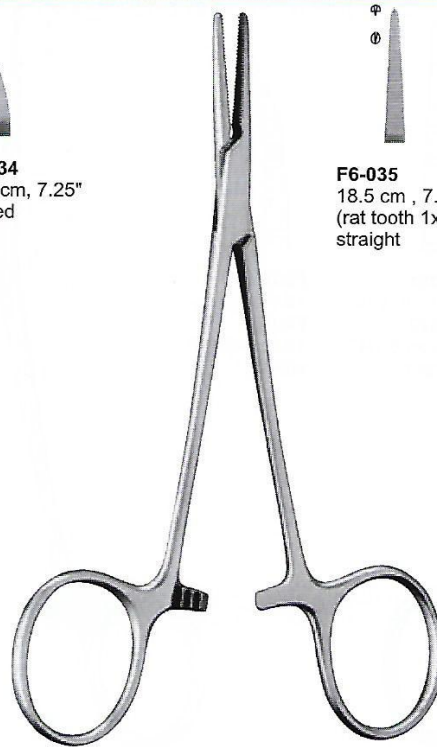

F6-035
18.5 cm, 7.25"
(rat tooth 1x2 teeth)
straight

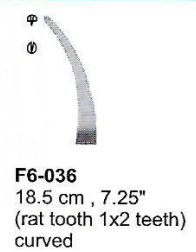

F6-036
18.5 cm, 7.25"
(rat tooth 1x2 teeth)
curved

Halsted Haemostatic Forceps

Halsted Haemostatic
Tissue Forceps



F6-037
18.5 cm, 7.25"
straight



F6-038
18.5 cm, 7.25"
curved

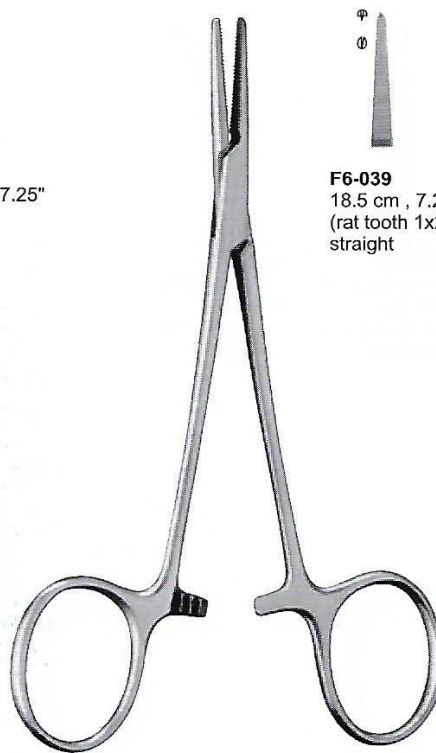

F6-039
18.5 cm, 7.25"
(rat tooth 1x2 teeth)
straight

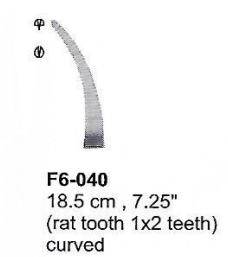

F6-040
18.5 cm, 7.25"
(rat tooth 1x2 teeth)
curved

Halsted Haemostatic
Fine point Forceps

Halsted Haemostatic Fine
Point Tissue Forceps

HAEMOSTATIC FORCEPS



Arterienklemmen
Pinces Hemostatiques

Pinzas Hemostaticas
Pinze Emostatiche



Packer Mosquito Forceps
F6-041 5", 12.7cm
curved, flat jaws



Coller Haemostatic Forceps



F6-042 14 cm, 5 1/2"
F6-043 16 cm, 6 1/4"
Straight, serrated

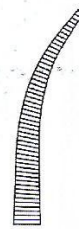

F6-044 14 cm, 5 1/2"
F6-045 16 cm, 6 1/4"
Curved, serrated

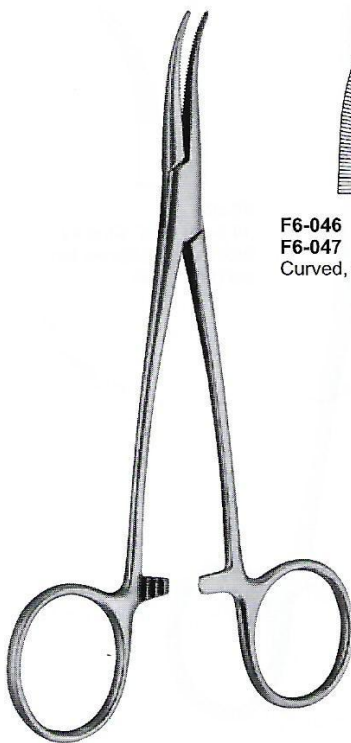

Christophe Haemostatic Forceps



F6-046 13.0 cm, 5"
F6-047 15.0 cm, 6"
Curved, Serrated

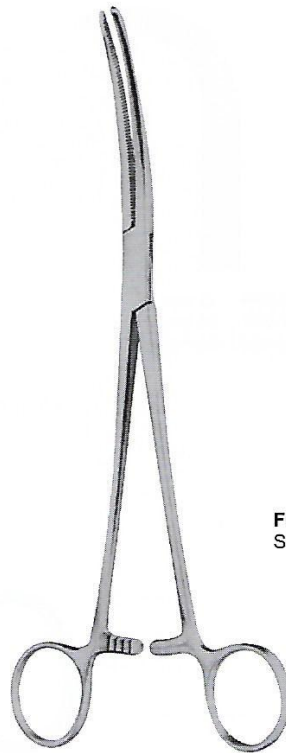

Saroot Haemostatic Forceps



F6-048 24 cm, 9 1/2"
Straight, Serrated

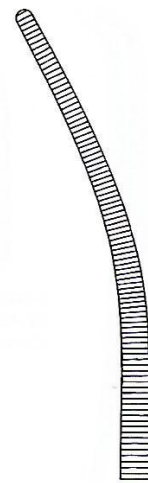

F6-049 24 cm, 9 1/2"
Curved Serrated



HAEMOSTATIC FORCEPS

Arterienklemmen
Pinces Hemostatiques

Pinzas Hemostaticas
Pinze Emostatiche

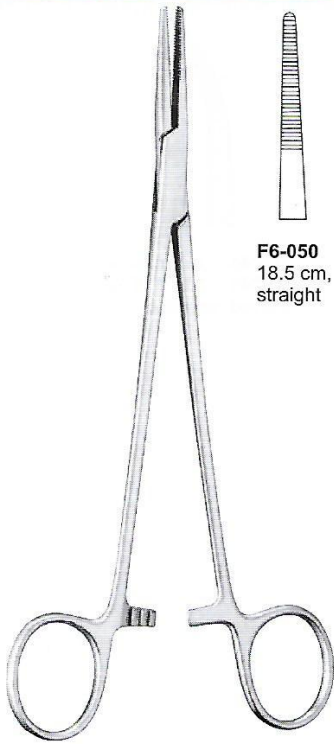

Adson Haemostatic Fine point Forceps

F6-050
18.5 cm, 7 1/4"
straight



F6-051
18.5 cm, 7 1/4"
curved



Adson Haemostatic Tissue Forceps

F6-052
18.5 cm, 7 1/4" straight
(rat tooth 1x2 teeth)



F6-053
18.5 cm, 7 1/4" Curved
(rat tooth 1x2 teeth)

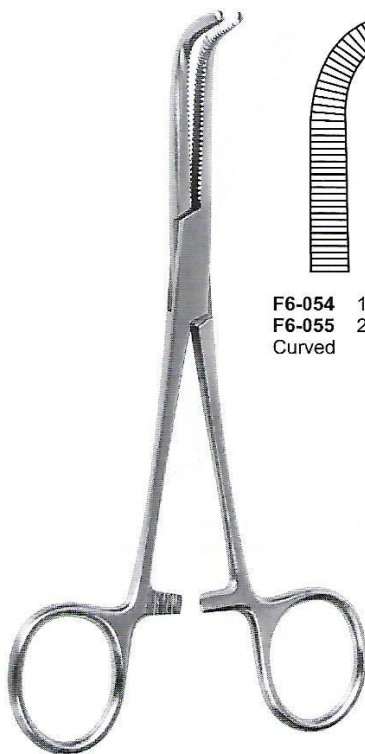
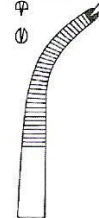

O'Shaughnessy Haemostatic Forceps

F6-054 15 cm, 6"
F6-055 20 cm, 8"
Curved

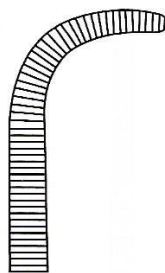

F6-056 15 cm, 6"
F6-057 20 cm, 8"
Curved Fine Point

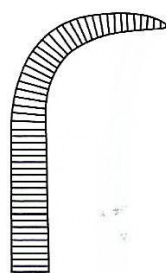

Cairns Haemostatic Forceps

F6-058
14.5 cm, 5 3/4" Straight,
box joint, as above but
curved on flat.

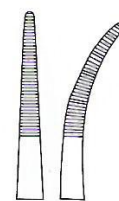

HAEMOSTATIC FORCEPS



Arterienklemmen
Pinces Hemostatiques

Pinzas Hemostaticas
Pinze Emostatiche

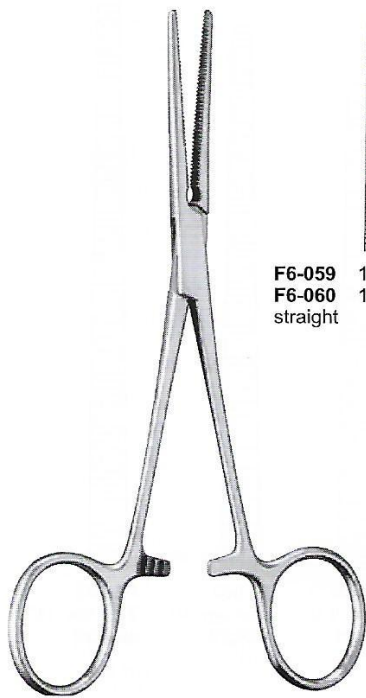

**Pean Haemostatic Forceps
Slender Type**

F6-059 13.0 cm, 5"
F6-060 14.0 cm, 5 1/2"
straight

F6-061 13.0 cm, 5"
F6-062 14.0 cm, 5 1/2"
curved

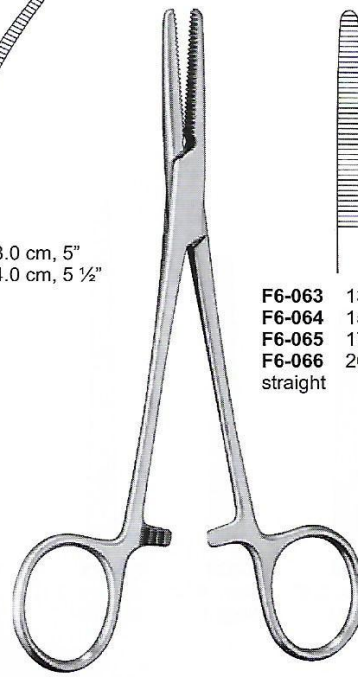

**Spencer-Wells Haemostatic Forceps
Slender Type**

F6-063 13.0 cm, 5"
F6-064 15.0 cm, 6"
F6-065 17.5 cm, 7"
F6-066 20 cm, 8"
straight

F6-067 13.0 cm, 5"
F6-068 15.0 cm, 6"
F6-069 17.5 cm, 7"
F6-070 20 cm, 8"
curved



**Kocher Haemostatic
Forceps Strong Pattern**

F6-071
14.5cm, 5 3/4"
Straight



**Kocher Haemostatic Forceps
1x2 teeth**

F6-072 13cm, 5"
F6-073 14cm, 5 1/2"
straight

F6-074 13cm, 5"
F6-075 14cm, 5 1/2"
curved









HAEMOSTATIC FORCEPS



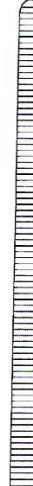

Arterienklemmen
Pinces Hemostatiques

Pinzas Hemostaticas
Pinze Emostatiche

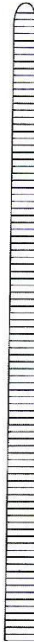
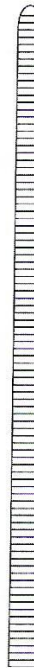
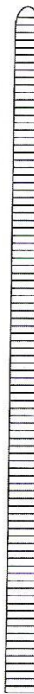
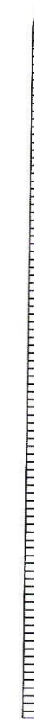

Rochester-Pean
Haemostatic Forceps
Straight

- 
F6-076
14 cm, 5.5"
straight
- 
F6-077
16cm, 6 ¼"
straight
- 
F6-078
18.5cm, 7 ¼"
straight
- 
F6-079
20cm, 8"
straight
- 
F6-080
22.5cm, 9"
straight
- 
F6-081
24cm, 9 ¾"
straight
- 
F6-082
25.4 cm, 10"
straight
- 
F6-083
27.9 cm, 11"
straight

- 
F6-084
30.5 cm,
12"
straight
- 
F6-085
35.6 cm,
14"
straight
- 
F6-086
40.64 cm,
16"
straight
- 
F6-087
45.72 cm,
18"
straight
- 
F6-088
50.8 cm,
20"
straight
- 
F6-089
55.88 cm,
22"
straight
- 
F6-090
60.96 cm,
24"
straight

HAEMOSTATIC FORCEPS

Arterienklemmen
Pincas Hemostaticas

Pinzas Hemostaticas
Pinze Emostatiche

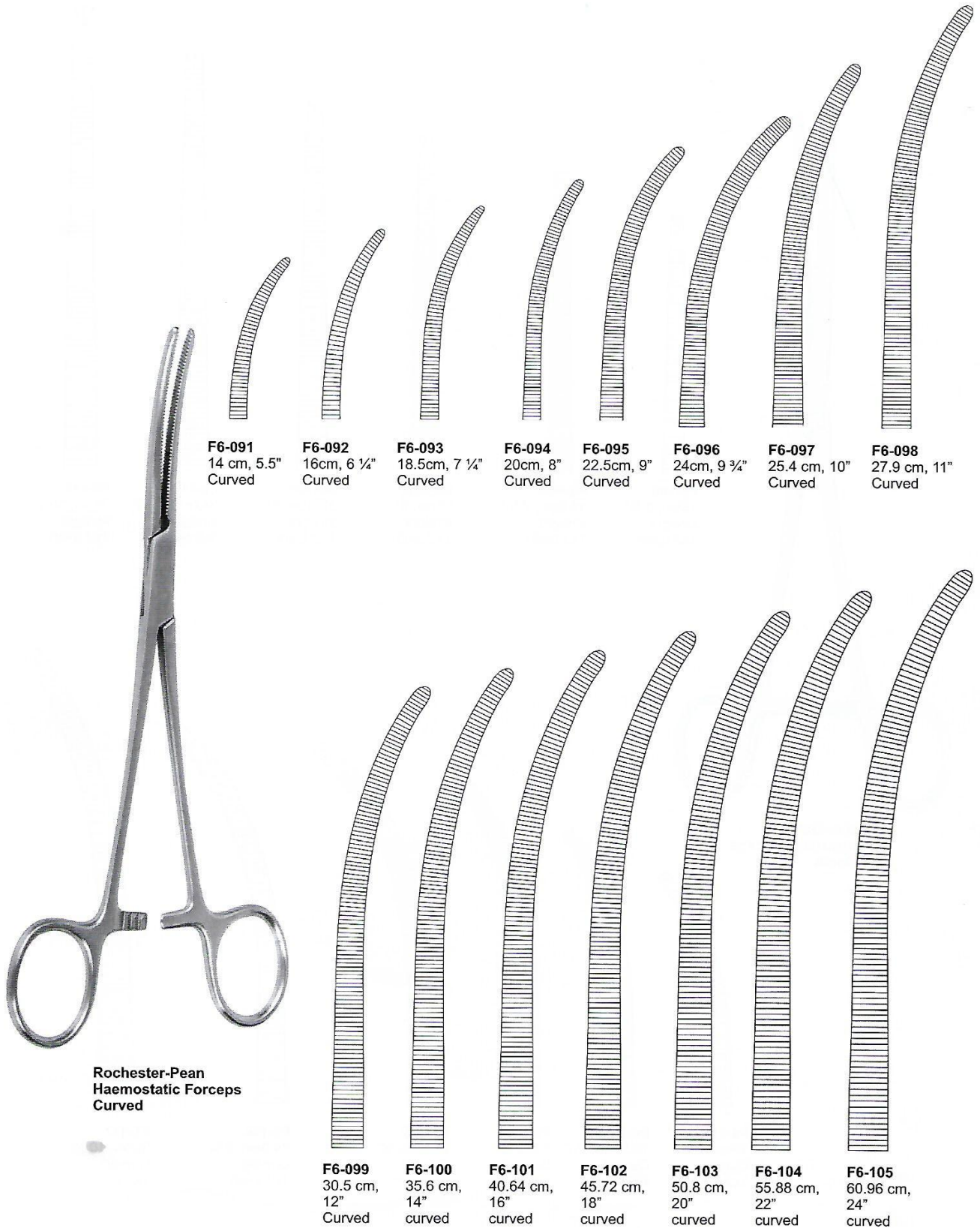

F6-091
14 cm, 5.5"
Curved

F6-092
16cm, 6 ¼"
Curved

F6-093
18.5cm, 7 ¼"
Curved

F6-094
20cm, 8"
Curved

F6-095
22.5cm, 9"
Curved

F6-096
24cm, 9 ¾"
Curved

F6-097
25.4 cm, 10"
Curved

F6-098
27.9 cm, 11"
Curved

**Rochester-Pean
Haemostatic Forceps
Curved**

F6-099
30.5 cm,
12"
Curved

F6-100
35.6 cm,
14"
curved

F6-101
40.64 cm,
16"
curved

F6-102
45.72 cm,
18"
curved

F6-103
50.8 cm,
20"
curved

F6-104
55.88 cm,
22"
curved

F6-105
60.96 cm,
24"
curved



HAEMOSTATIC FORCEPS

Arterienklemmen
Pinces Hemostatiques

Pinzas Hemostaticas
Pinze Emostatiche

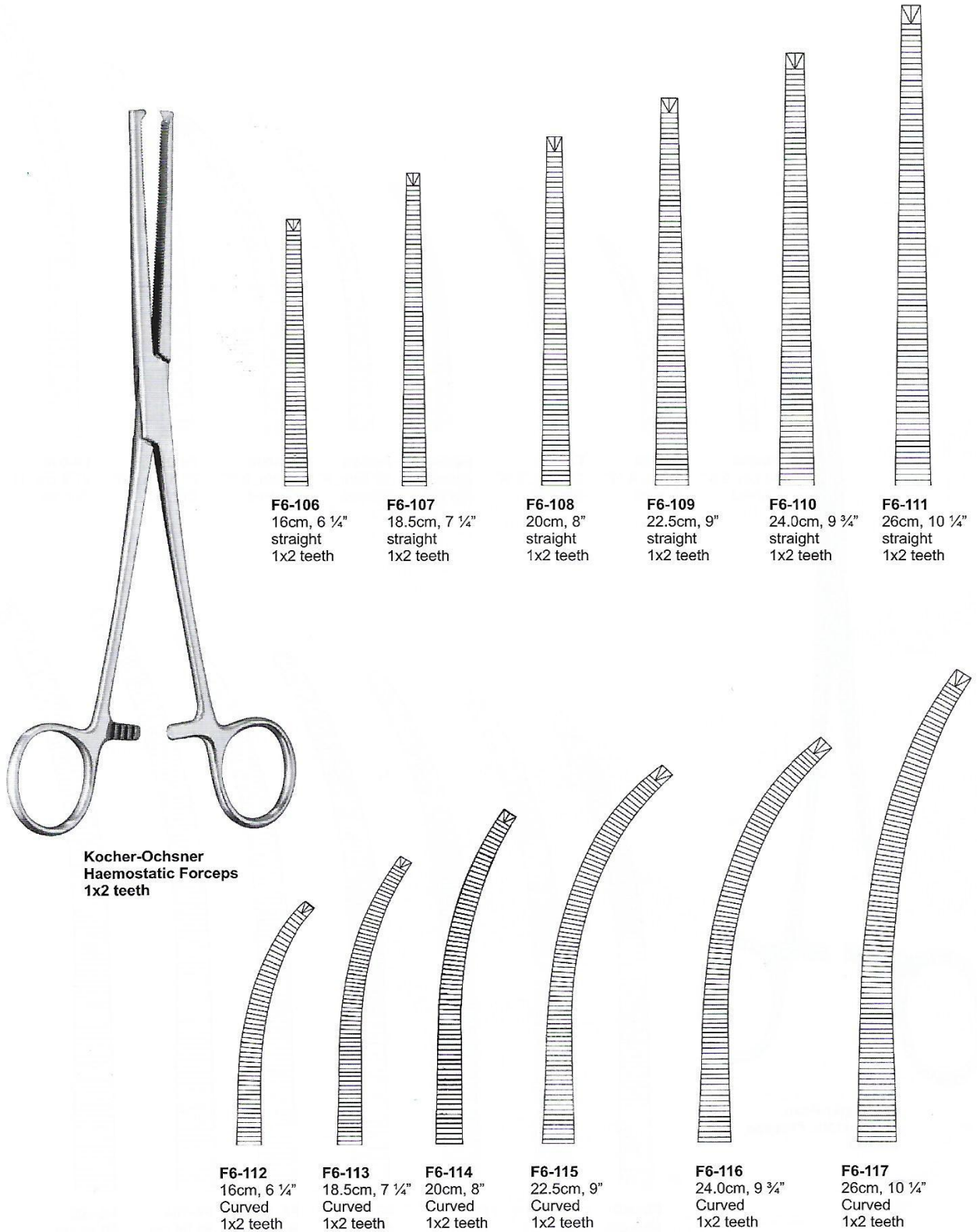

HAEMOSTATIC FORCEPS



Arterienklemmen
Pinces Hemostatiques

Pinzas Hemostaticas
Pinze Emostatiche

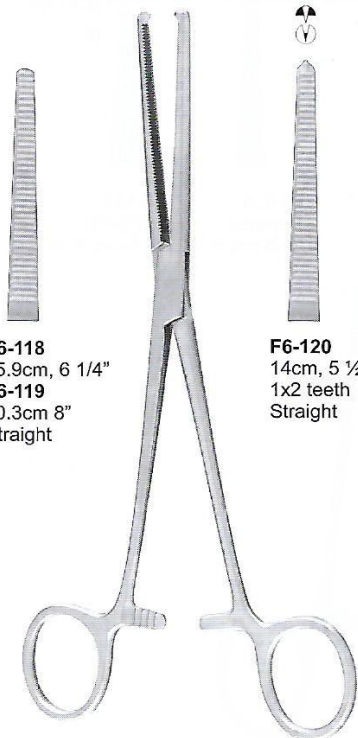

F6-118
15.9cm, 6 1/4"
F6-119
20.3cm 8"
Straight



F6-120
14cm, 5 1/2"
1x2 teeth
Straight



F6-121
14cm, 5 1/2"
1x2 teeth
Curved

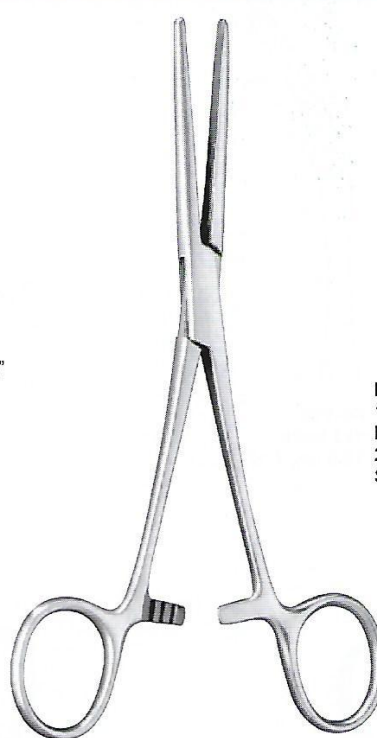

F6-122
16 cm, 6 1/4"
F6-123
20 cm, 8"
Straight



F6-124
16 cm, 6 1/4"
F6-125
20 cm, 8"
Curved

Rochester-Ochsner
Haemostatic Forceps

Rochester-Carmalt
Haemostatic Forceps

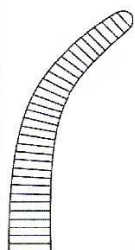
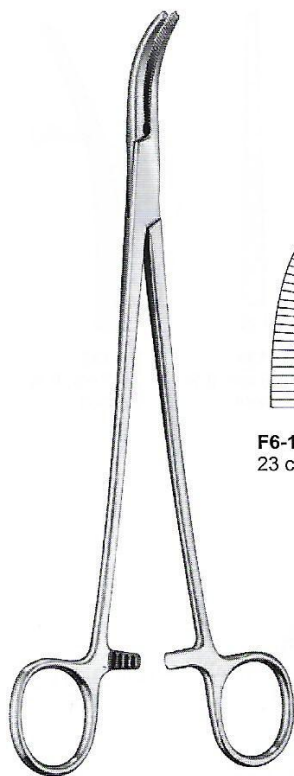

F6-126
23 cm, 9"

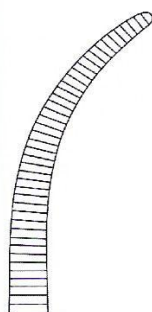

F6-127
24 cm, 9 3/4"

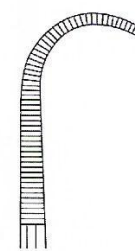
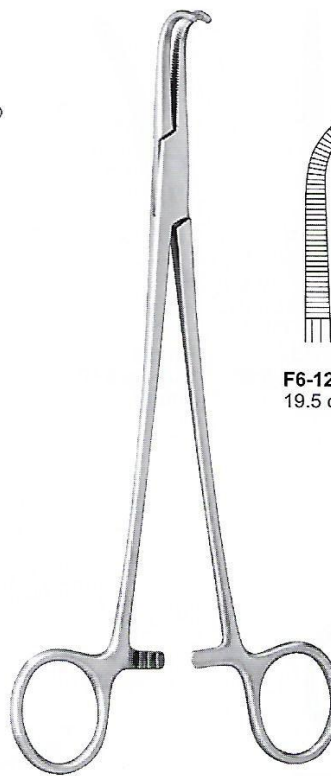

F6-128
19.5 cm, 7 3/4"



F6-129
19.5 cm, 7 3/4"

Moynihan Haemostatic Forceps

Negus Haemostatic Forceps



HAEMOSTATIC FORCEPS

Arterienklemmen
Pincas Hemostatiques

Pinzas Hemostaticas
Pinze Emostatiche

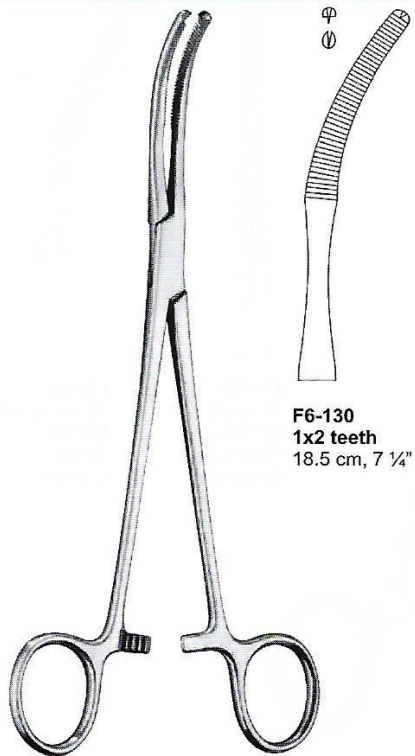

F6-130
1x2 teeth
18.5 cm, 7 1/4"

Mikulicz Haemostatic Tissue Forceps



F6-131
Serrated
21.5 cm, 8 1/2"

F6-132
1x2 teeth
21.5 cm, 8 1/2"

Halsted Haemostatic Forceps



F6-133
24.5 cm, 9 3/4"
straight

F6-134
24.5 cm, 9 3/4"
Curved

Bengolea Haemostatic Forceps

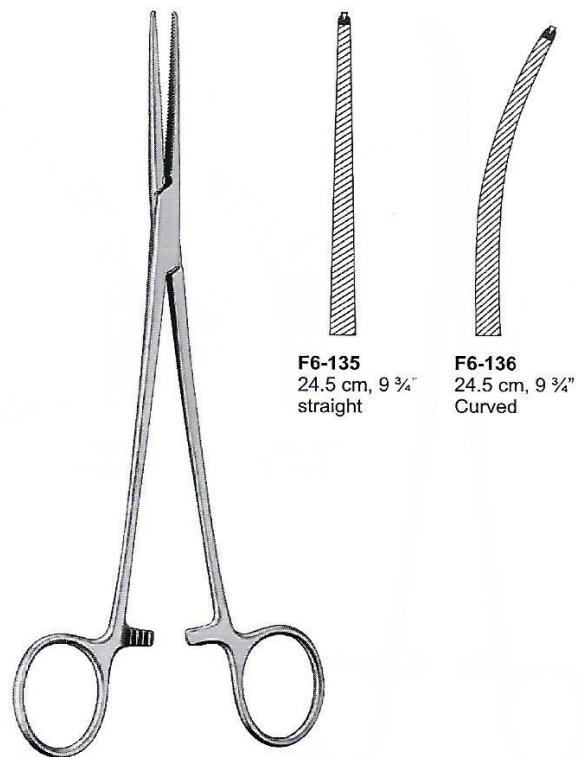

F6-135
24.5 cm, 9 3/4"
straight

F6-136
24.5 cm, 9 3/4"
Curved

Bengolea Haemostatic Tissue Forceps
(rat tooth 1x2 teeth)

HAEMOSTATIC FORCEPS



Arterienklemmen
Pincas Hemostatiques

Pinzas Hemostaticas
Pinze Emostatiche



- F6-137 14 cm, 5 1/2"
- F6-138 16.5 cm, 6 1/2"
- F6-139 19 cm, 7 1/2"
- F6-140 21.5 cm, 8 1/2"
- F6-141 24 cm, 9 1/2"

Mixer-O'Shaugnessy
Haemostatic Forceps



- F6-142 14 cm, 5 1/2"
- F6-143 16.5 cm, 6 1/2"
- F6-144 19 cm, 7 1/2"
- F6-145 21.5 cm, 8 1/2"
- F6-146 24 cm, 9 1/2"
- Fine Point

Mixer-O'Shaugnessy
Haemostatic Forceps

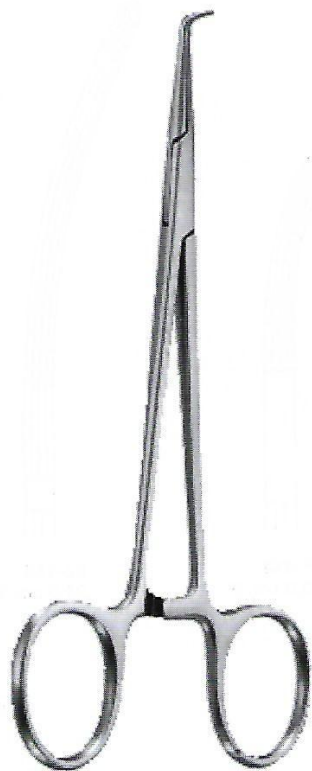

- Mixer-O'Shaugnessy
Haemostatic Forceps**
- F6-147 14cm, 5 1/2"
 - F6-148 16.5cm, 6 1/2"
 - F6-149 19cm, 7 1/2"
 - F6-150 21.5cm, 8 1/2"
 - F6-151 24cm, 9 1/2"
 - micro point

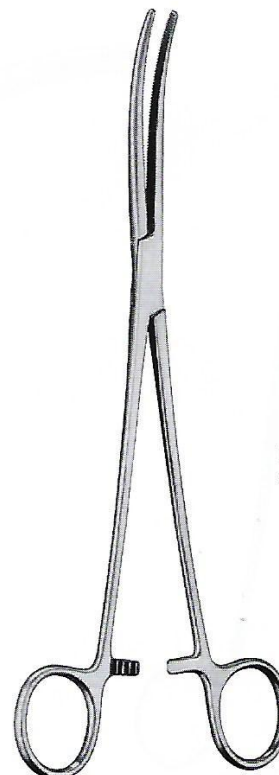

- F6-152
24.5 cm, 9 3/4"

Craford Haemostatic Forceps



HAEMOSTATIC FORCEPS

Arterienklemmen

Pinces Hemostatiques

Pinzas Hemostaticas

Pinze Emostatiche



Herrick Haemostatic Forceps
F6-153 23.0 cm, 9"

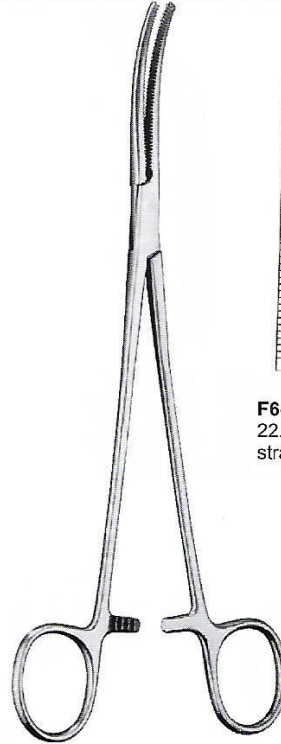
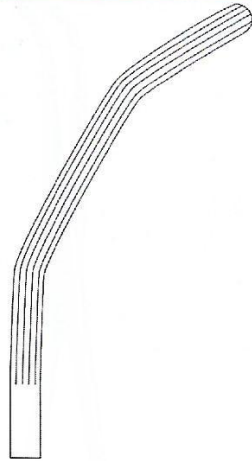

Roberts Haemostatic Forceps



F6-154
22.0 cm, 8 3/4"
straight

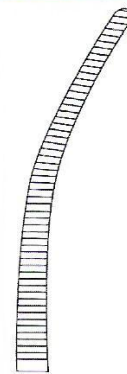

F6-155
22.0 cm, 8 3/4"
Curved



**Crafoord-Sellors
Haemostatic Forceps**

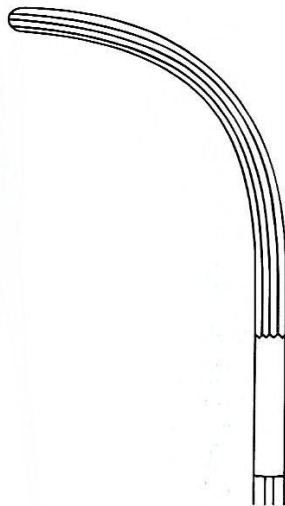

F6-156
22.0 cm, 8 3/4"

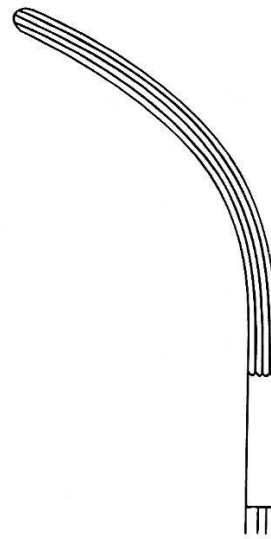

F6-157
23.0 cm, 9"



F6-158
24.0 cm, 9 1/2"

HAEMOSTATIC FORCEPS



Arterienklemmen
Pincas Hemostatiques

Pinzas Hemostaticas
Pinze Emostatiche

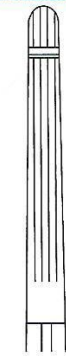

F6-159
20 cm, 8"
Straight,
Serrated

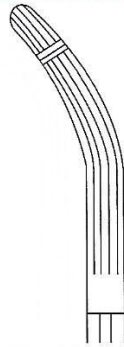

F6-160
20 cm, 8"
Slight Curve,
Serrated



F6-161 21 cm, 8 1/4"
Straight, Cross Serrated
F6-162 21 cm, 8 1/4"
Slight curved, Cross
Serrated

**Heaney / Ballantine
Haemostatic Forceps**

**Heaney / Rezak
Haemostatic Forceps**

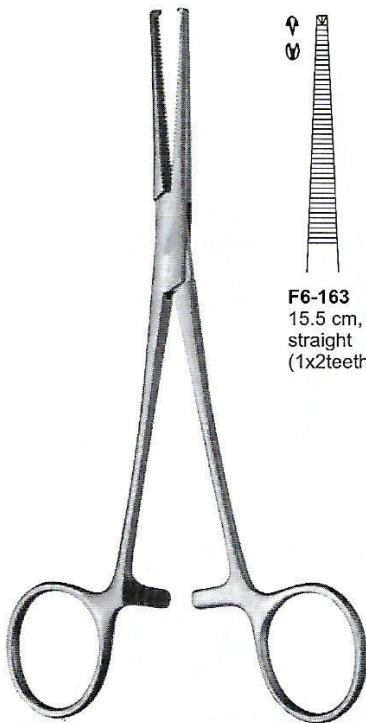

F6-163
15.5 cm, 6"
straight
(1x2teeth)



F6-164
15.5 cm, 6"
Curved
(1x2teeth)

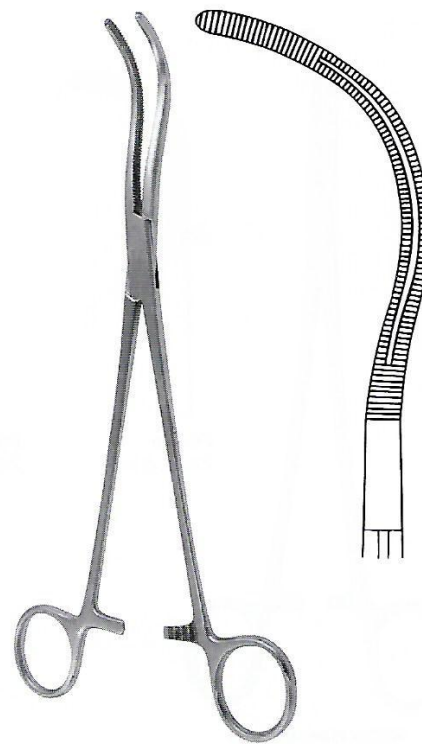

**Dixon-Lovelace
Haemostatic Tissue Forceps**

Stille Haemostatic Forceps
F6-165 23 cm, 9"



HAEMOSTATIC FORCEPS

Arterienklemmen
Pinces Hemostatiques

Pinzas Hemostaticas
Pinze Emostatiche

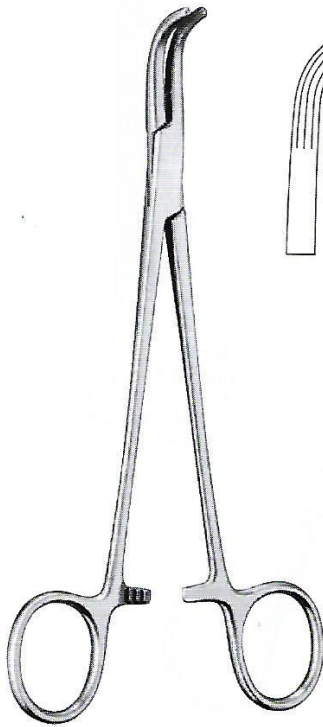

Lower Haemostatic Forceps
F6-166 18cm, 7"

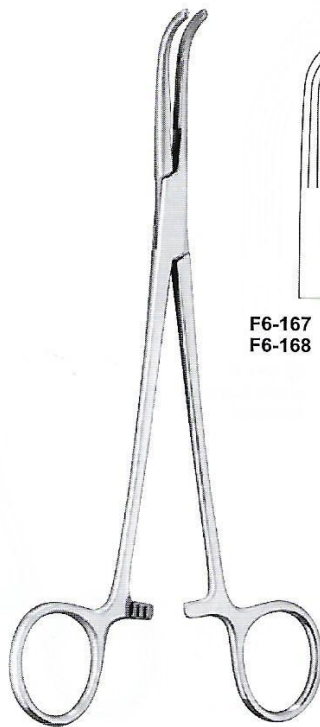

Lahey (Sweet) Haemostatic Forceps

F6-167 19cm, 1/2"
F6-168 22cm, 8 3/4"



Desjardins Haemostatic Forceps
F6-169 22cm, 8 3/4"

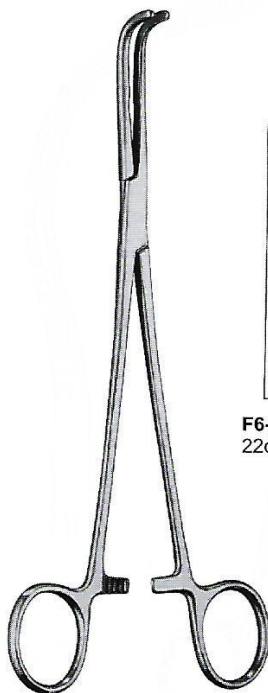

Mixer Haemostatic Gall Duct Forceps

F6-170
22cm, 8 3/4"

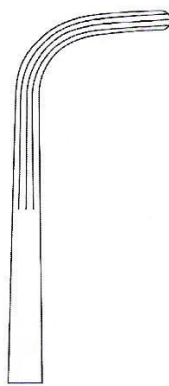

F6-171
25cm, 10"

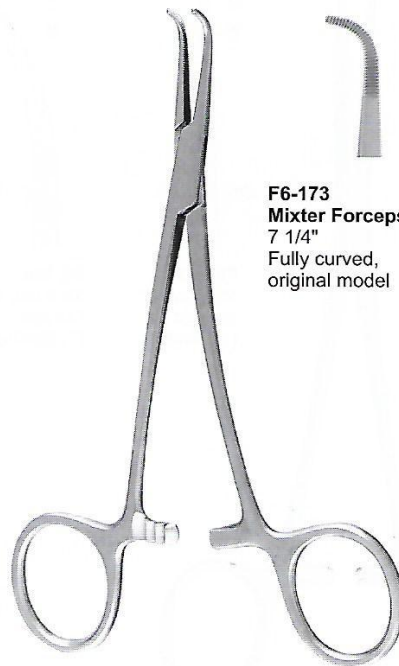

Mixer Forceps, Lee Modif
F6-172 13.3 cm , 5.25"
Curved jaws and angled shanks, delicate

F6-173
Mixer Forceps, 18.4 cm
7 1/4"
Fully curved, original model

HAEMOSTATIC FORCEPS



Arterienklemmen
Pincas Hemostatiques

Pinzas Hemostaticas
Pinze Emostatiche

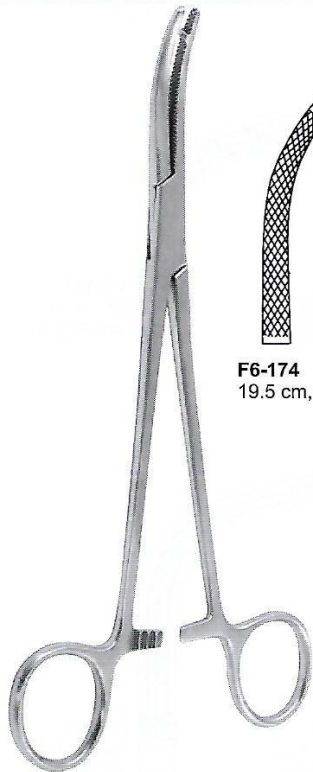

Heaney Haemostatic Forceps

F6-174
19.5 cm, 7 1/2"

F6-175
21.5 cm, 8 1/2"

F6-176
24 cm, 9 1/2"

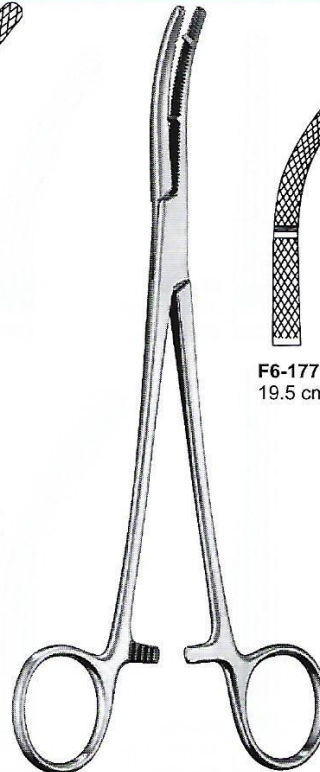

Heaney Modif. Haemostatic Forceps

F6-177
19.5 cm, 7 1/2"

F6-178
21.5 cm, 8 1/2"

F6-179
24 cm, 9 1/2"

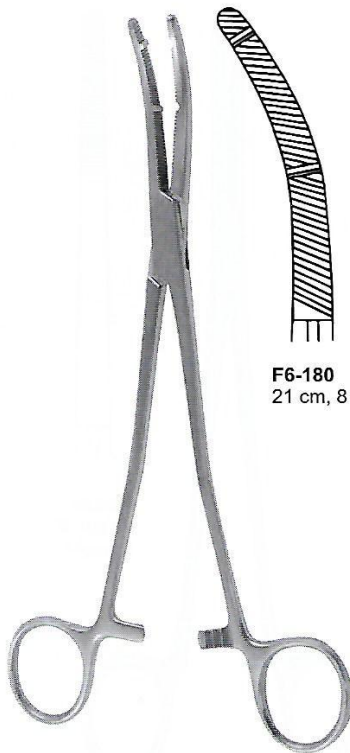

Heaney-Kanter
Haemostatic Forceps

F6-180
21 cm, 8 1/4"

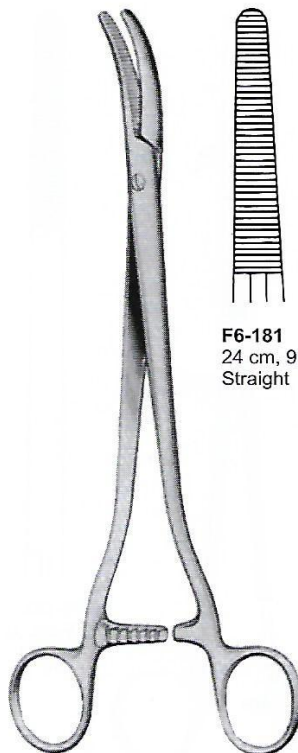

Segond-Landau
Haemostatic Forceps

F6-181
24 cm, 9 1/2"
Straight

F6-182
24 cm, 9 1/2"
Curved



Schindler Haemostatic Tissue
Forceps

F6-183
1x2 teeth
20 cm, 8"



HAEMOSTATIC FORCEPS

Arterienklemmen
Pinces Hemostatiques

Pinzas Hemostaticas
Pinze Emostatiche



Parametrium Haemostatic Forceps

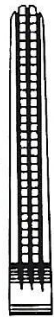

F6-184
21 cm, 8 1/4"
Straight



F6-185
21 cm, 8 1/4"
25° Angled

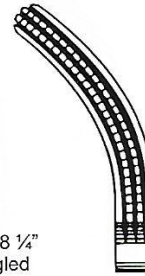

F6-186
21 cm, 8 1/4"
45° Angled

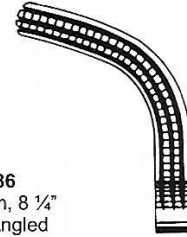

F6-187
21 cm, 8 1/4"
90° Angled

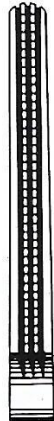

F6-188
24 cm, 9 1/2"
Straight



F6-189
24 cm, 9 1/2"
25° Angled

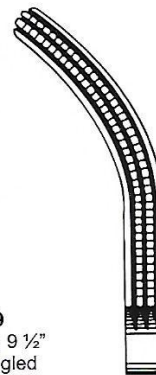

F6-190
24 cm, 9 1/2"
45° Angled

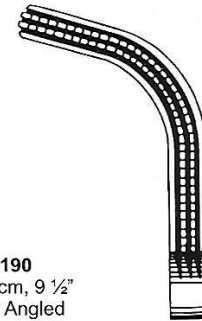

F6-191
24 cm, 9 1/2"
90° Angled

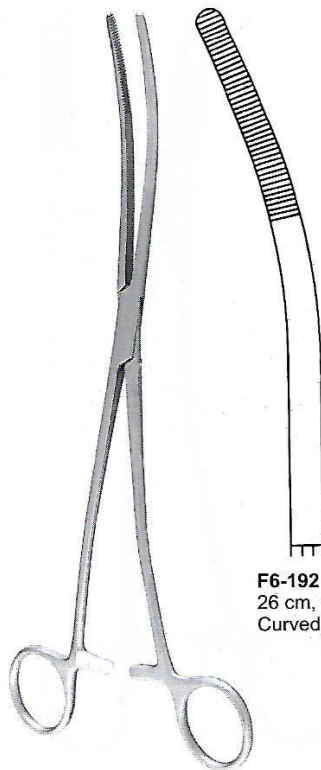

F6-192
26 cm, 10 1/4"
Curved, Serrated

Bozemann Haemostatic Forceps

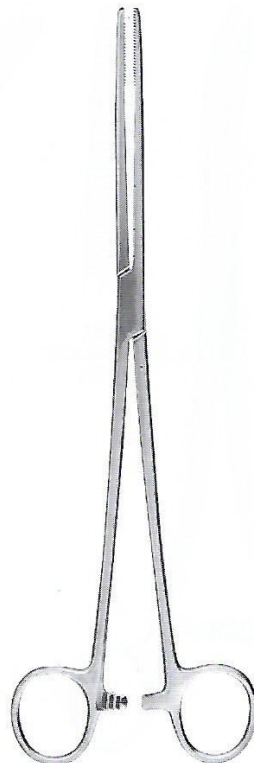

F6-193
26 cm, 10 1/4"
Straight

Bozemann Haemostatic Forceps

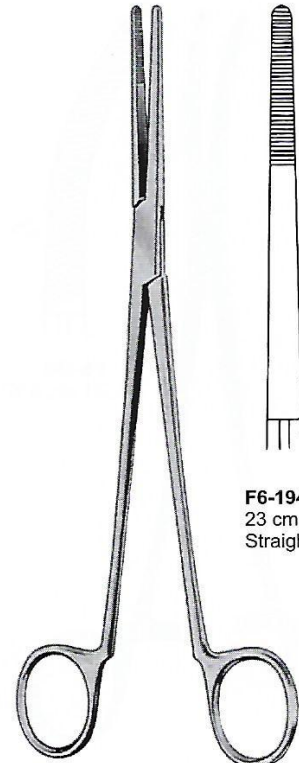

F6-194
23 cm, 9"
Straight

Westermark Haemostatic Forceps

HAEMOSTATIC FORCEPS



Arterienklemmen
Pincas Hemostaticas

Pinzas Hemostaticas
Pinze Emostatiche



F6-195
1x2 teeth
21.5 cm, 8 1/2"
Straight

Phaneuf Haemostatic Tissue Forceps

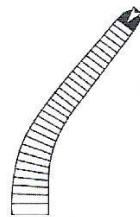
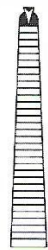

F6-196
1x2 teeth
21.5 cm, 8 1/2"
Hard Curved



F6-197
1x2 teeth
19.0 cm, 7 1/2"
Curved

Long Haemostatic Tissue Forceps



F6-198
1x2 teeth
19.0 cm, 7 1/2"
Straight



F6-199
1x2 teeth
14 cm, 5 1/2"

Baby-Mikulicz Haemostatic Tissue Forceps

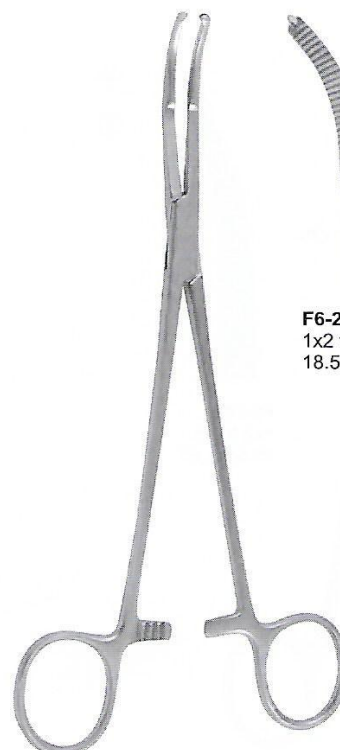

F6-200
1x2 teeth
18.5cm, 7 1/4"

Mikulicz Haemostatic Tissue Forceps





HAEMOSTATIC FORCEPS

Arterienklemmen
Pincas Hemostatiques

Pinzas Hemostaticas
Pinze Emostatiche



F6-201
1x2 teeth
20.5cm, 8"

Mikulicz Haemostatic Tissue Forceps



F6-202
1x2 teeth
20.5cm, 8"

Mikulicz Haemostatic Tissue Forceps



F6-203
1x2 teeth
20.5cm, 8"

Mikulicz Haemostatic Tissue Forceps



F6-204
1x2 teeth
20.5cm, 8"

Faure Haemostatic Tissue Forceps

HAEMOSTATIC FORCEPS



Arterienklemmen
Pinces Hemostatiques

Pinzas Hemostaticas
Pinze Emostatiche

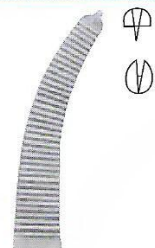

F6-205
1x2 teeth
23.5cm, 9 1/4"

**Wertheim Haemostatic
Tissue Forceps**

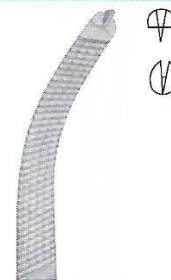
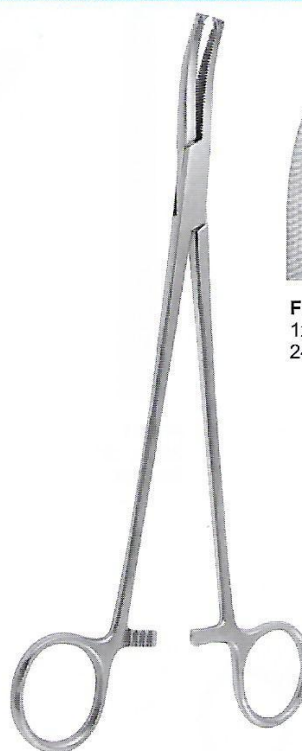

F6-206
1x2 teeth
24.5cm, 9 3/4"

**Wertheim Haemostatic
Tissue Forceps**



F6-207
22.5cm, 9"
Straight



F6-208
22.5cm, 9"
25° Angled

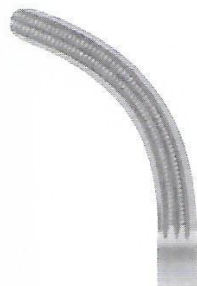

F6-209
21.5cm, 8 1/2"
45° Angled

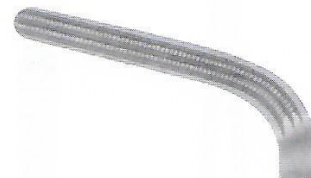

F6-210
20.5cm, 8"
90° Angled

**Heaney Atraumata
Hysterectomy Forceps**



HAEMOSTATIC FORCEPS

Arterienklemmen
Pinces Hemostatiques

Pinzas Hemostaticas
Pinze Emostatiche



Wertheim Parametrium Clamps



F6-211
25cm, 10"
Straight



F6-212
24.5cm, 9 3/4"
25° Angled

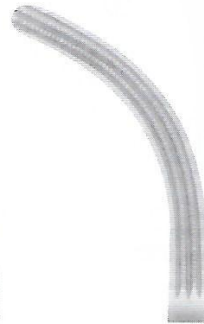

F6-213
24cm, 9 1/2"
45° Angled

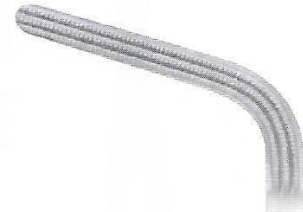

F6-214
22cm, 8 3/4"
90° Angled



Wertheim Hysterectomy Forceps



F6-215
25.5cm, 10"



Wertheim Parametrium Clamp



F6-216
26cm, 10 1/4"



Gemini Mixer Hemostatic Forceps

F6-217 5 1/2"
F6-218 7"
full curve, delicate

HAEMOSTATIC FORCEPS



Arterienklemmen
Pinces Hemostatiques

Pinzas Hemostaticas
Pinze Emostatiche



Dick Haemostatic Forceps

F6-219
25.5cm, 10"



F6-220
26.5cm, 10 1/2"



F6-221
27.5cm, 10 3/4"

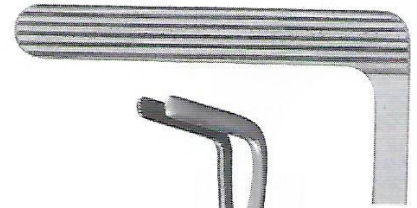
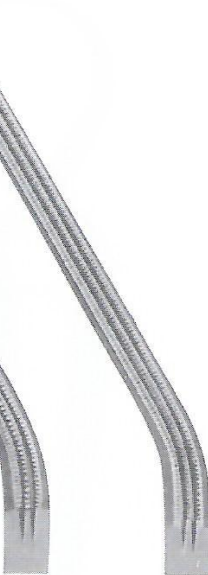

F6-222
21.5cm, 8 1/2"



Wertheim-Cullen
Haemostatic Forceps



Wertheim-Cullen Haemostatic
Forceps
23cm, 9"

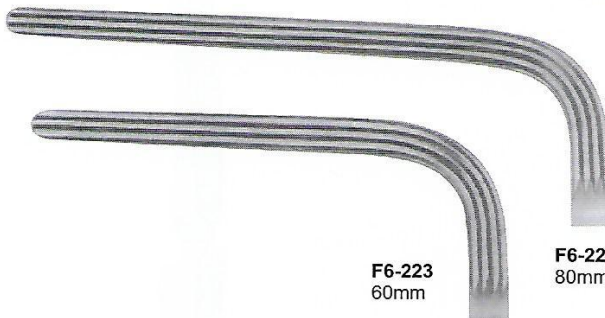

F6-223
60mm

F6-224
80mm



F6-225
25cm, 10"

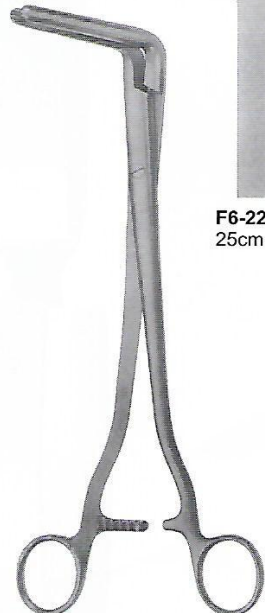

Wertheim Haemostatic Forceps



TOWEL FORCEPS

Tuchklemmen | Pincés à champs
Pinzas de campo | Pinze fissatele



**Jones / Perforating
Towel Forceps**
F6-226 9 cm, 3 1/2"
Slight Curve



**Engl. Modell
Towel Forceps**
F6-227
9 cm, 3 1/2"



**Schaedel Towel
Forceps**
F6-228
9 cm, 3 1/2"



**Thomson-Walker's
Penile Clamps**
F6-229 9 cm, 3 1/2"
Cross-Action model.



Doyen Towel Forceps
F6-230 18 cm, 7"

TOWEL FORCEPS



Tuchklemmen | Pincès à champs
Pinzas de campo | Pinze fissatele

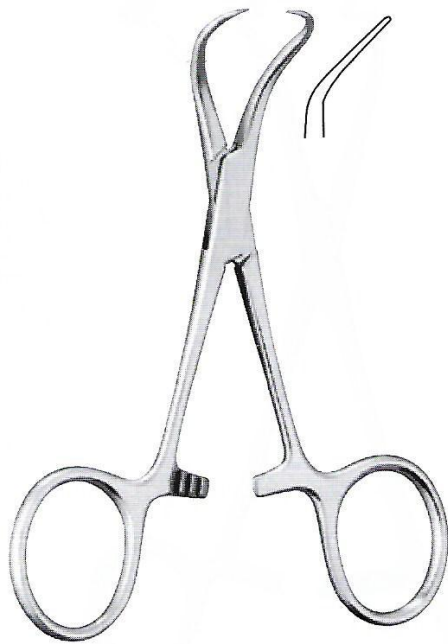

Backhaus Towel Forceps
F6-231 8 cm, 3"
F6-232 11 cm, 4 1/2"
F6-233 13 cm, 5"
F6-234 15 cm, 5 3/4"
Curved



Backhaus Clip Towel Forceps
F6-235 11 cm, 4 1/2"
with clip for tubing or cable



Roeder Towel Forceps
F6-236 13 cm, 5"
F6-237 15 cm, 6"
Curved, Serrated



Lorna Towel Forceps
F6-238 9.0 cm, 3 1/2"
F6-239 11.4 cm, 4 1/2"
F6-240 13.5 cm, 5 1/4"



Ball & Socket Towel Forceps
F6-241 13 cm, 5"
Non-perforating



Tohoku Towel Forceps
F6-242 10cm, 4"
F6-243 13cm, 5"
Non-Perforating



HAEMOSTATIC FORCEPS

Arterienklemmen
Pincers Hemostatiques

Pinzas Hemostaticas
Pinze Emostatiche



Non-Perforating Towel Forceps
F6-244 11 cm, 4 1/2"
F6-245 13 cm, 5"



Peers-Bertman Towel Forceps
F6-246 14.5 cm, 5 3/4"
Serrated



Bernhard Towel Forceps
F6-247
16.5 cm, 6 1/2"

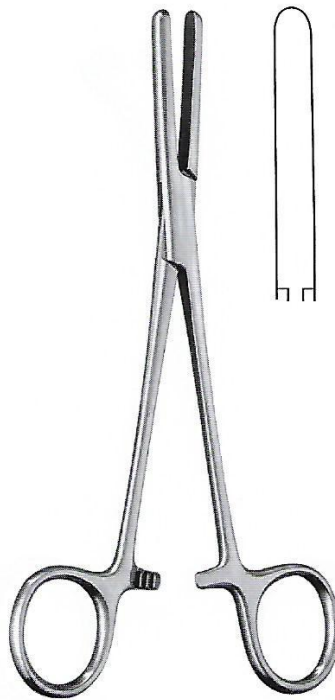

Presbyterian Tubing Clamp
F6-248 16.5 cm, 6 1/2"
F6-249 18 cm, 7"
Straight, Smooth



Tubing Clamp
F6-250 18 cm, 7"
F6-251 20 cm, 8"
Cross Serrated

HAEMOSTATIC FORCEPS



Arterienklemmen

Pinzas Hemostaticas

Pinces Hemostatiques

Pinze Emostatiche

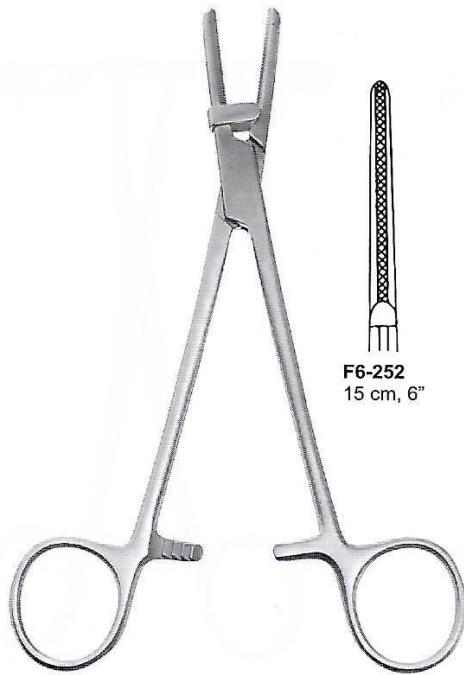

**Tubing Clamp with Protector,
Cross Serrated**

F6-252
15 cm, 6"



F6-253
18 cm, 7"



F6-254
20 cm, 8"



Klinikum Berlin Tubing Clamp

F6-255 14.5 cm, 5 3/4"
with long ratchet

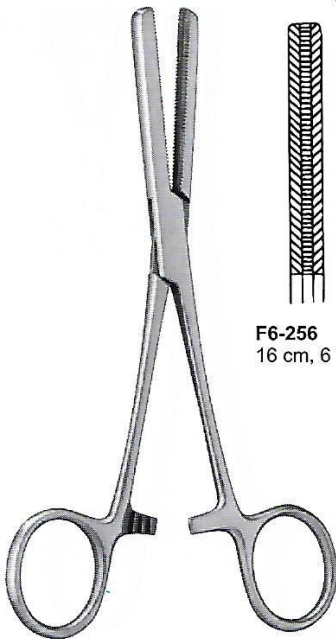

Fergusson Tubing Clamp

F6-256
16 cm, 6 1/4"



F6-257
20 cm, 8"

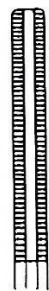

F6-258
16 cm, 6 1/4"



F6-259
20 cm, 8"

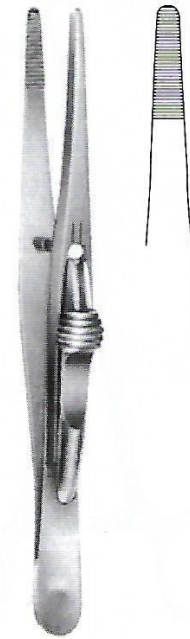
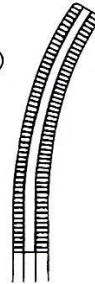

Fricke Artery Forceps
F6-260 13cm, 5 1/4"



HAEMOSTATIC FORCEPS

Arterienklemmen
Pinces Hemostatiques

Pinzas Hemostaticas
Pinze Emostatiche

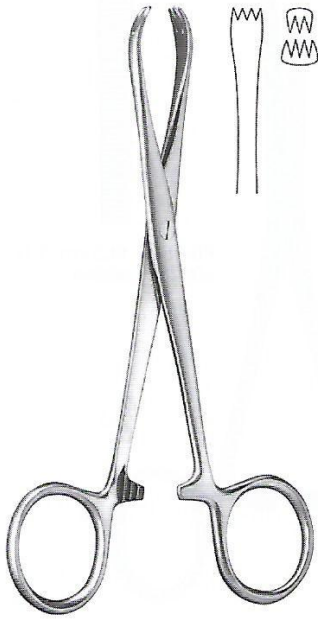

Tuffier Haemostatic Forceps
F6-261 13.0 cm, 5"

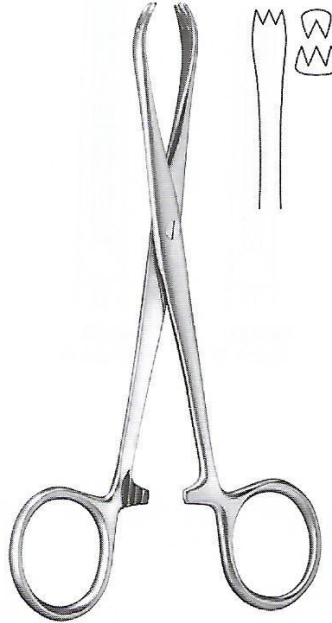

Chaput Haemostatic Forceps
F6-262 13.0 cm, 5"



Martel Haemostatic Forceps
F6-263 14.0 cm, 5 1/2"

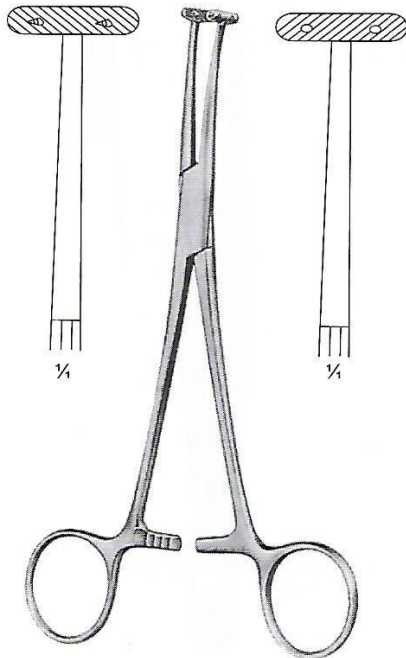

Willet-Martel Haemostatic Forceps
F6-264 19.0 cm, 7 1/2"



Pratt Haemostatic Forceps
F6-265 15 cm, 4 3/4"

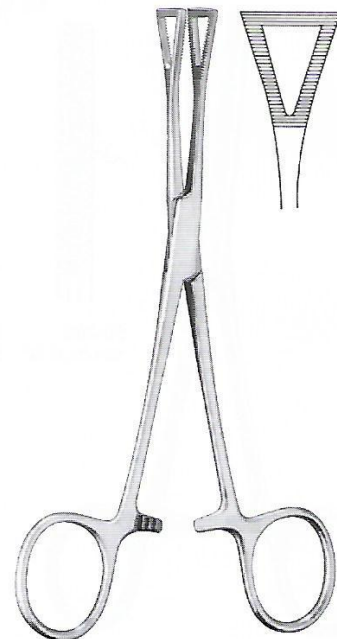

Pennington / Siezing Haemostatic Forceps
F6-266 15.5 cm, 6"
F6-267 20 cm, 8"
Straight

HAEMOSTATIC FORCEPS



Arterienklemmen
Pincas Hemostatiques

Pinzas Hemostaticas
Pinze Emostatiche

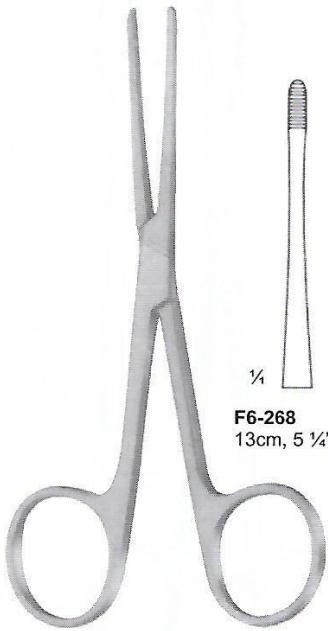

F6-268
13cm, 5 1/4"

Lister Sinus Forceps



F6-269
15.5cm, 6"



F6-270
17.5cm, 7"

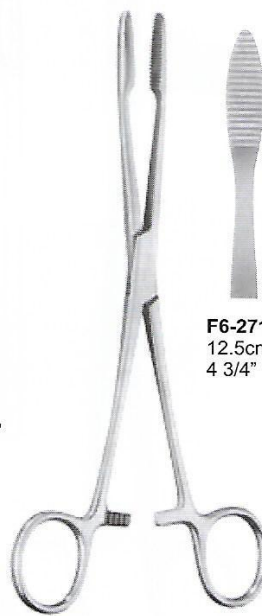

F6-271
12.5cm,
4 3/4"

**Collin Dressing
Haemostatic Forceps**



F6-272
14cm, 5 1/2"

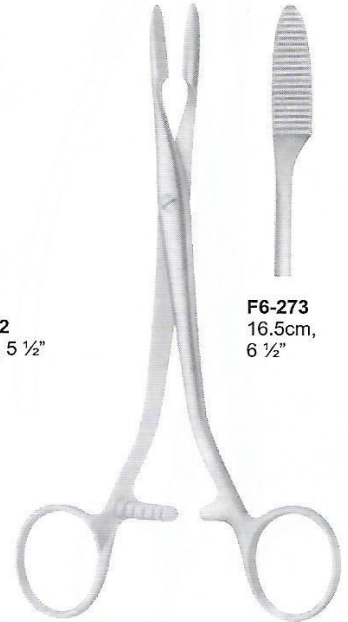

F6-273
16.5cm,
6 1/2"

**Colling Dressing
Haemostatic Forceps**



F6-274
18.5cm,
7 1/4"

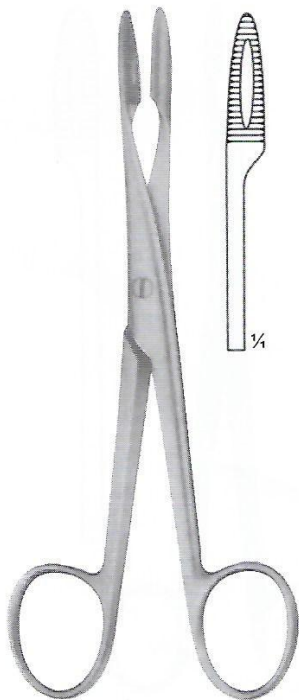

Gross Maier Dressing Forceps
F6-275 14.5cm, 5 3/4" straight
Without Ratchet

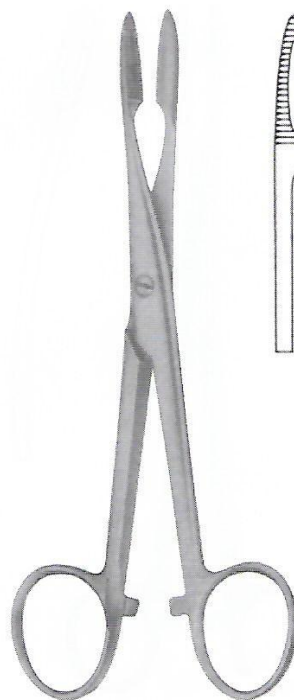

Gross Maier Dressing Forceps
F6-276 14.5cm, 5 3/4" straight
With Ratchet

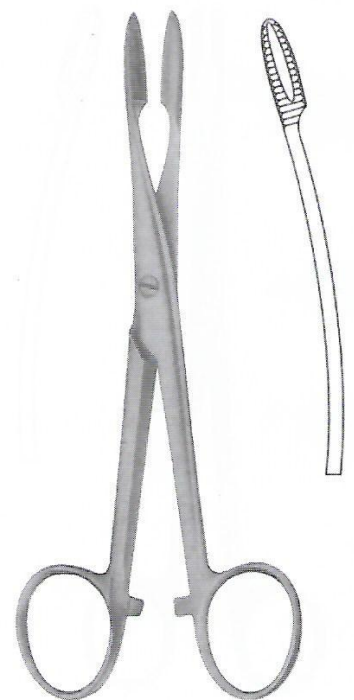

Gross Maier Dressing Forceps
F6-277 14.5cm, 5 3/4" curved
With Ratchet



HAEMOSTATIC FORCEPS

Arterienklemmen
Pincas Hemostatiques

Pinzas Hemostaticas
Pinze Emostatiche

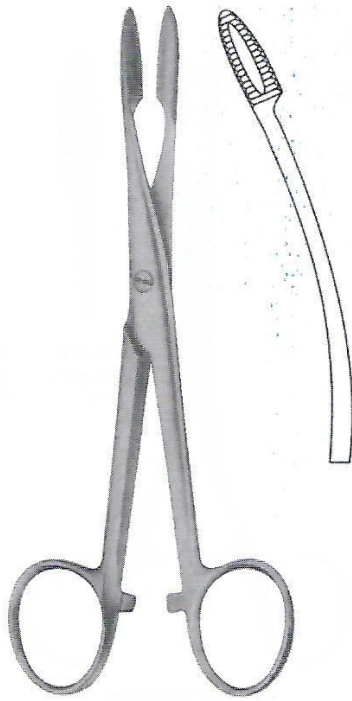

Gross Maier Dressing Forceps
F6-278 14.5cm, 5 3/4" curved
With Ratchet

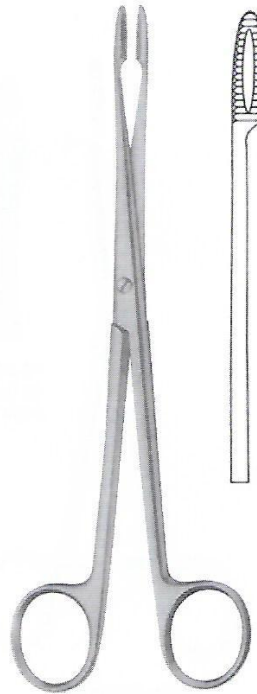

**Gross Maier Dressing
Sponge & Dressing Forceps**
F6-279 20.5 cm, 8" straight
Without Ratchet

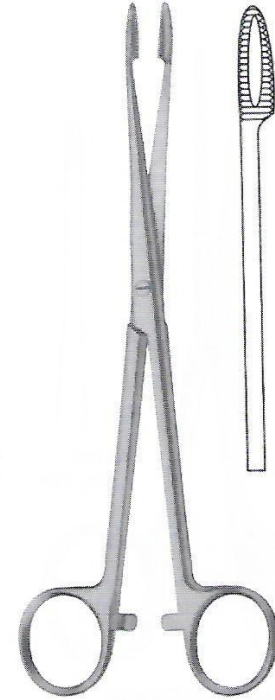

**Gross Maier Dressing
Sponge & Dressing Forceps**
F6-280 17.8 cm, 7" straight
With Ratchet

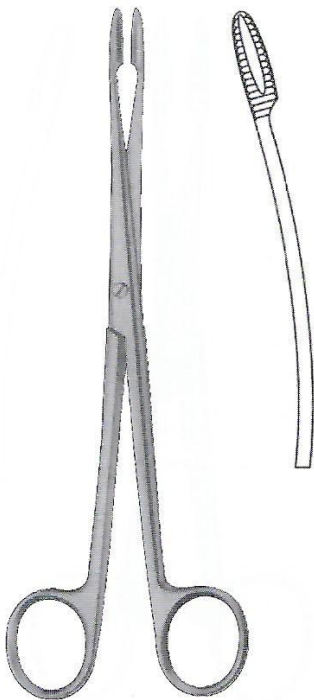

**Gross Maier Dressing
Sponge & Dressing Forceps**
F6-281 20.5 cm, 8" curved
Without Ratchet
(bullet holding forceps)

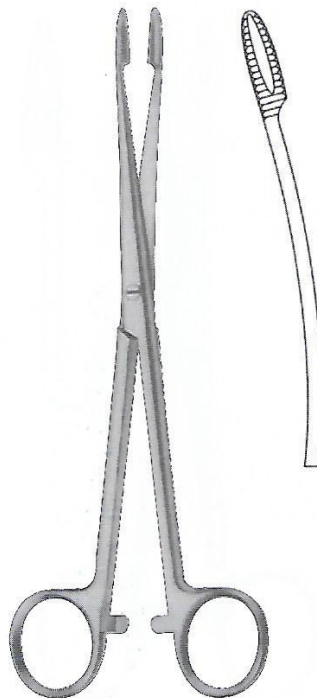

**Gross Maier Dressing
Sponge & Dressing Forceps**
F6-282 17.8 cm, 7" curved
With Ratchet

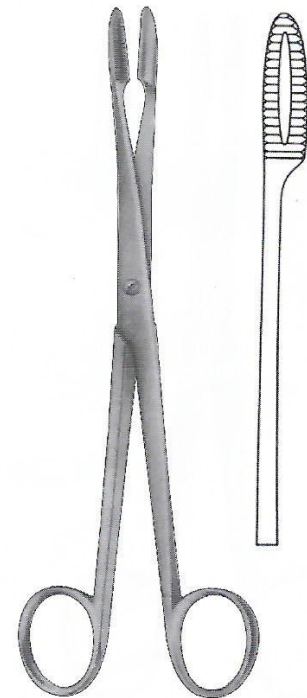

Gross Maier Dressing Forceps
F6-283 26.5cm, 10 1/2" straight
Without Ratchet
(bullet holding forceps)

HAEMOSTATIC FORCEPS



Arterienklemmen
Pinces Hemostatiques

Pinzas Hemostaticas
Pinze Emostatiche

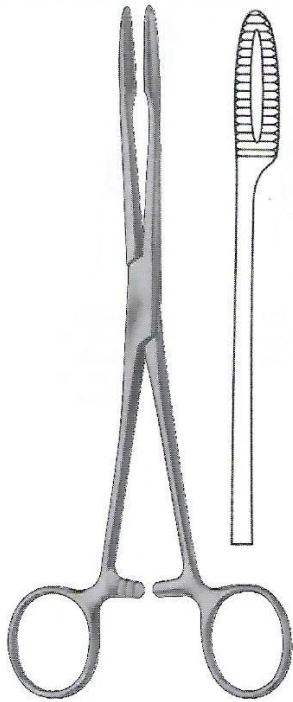

Gross Maier Dressing Forceps
F6-284 26.5cm, 10 1/2" straight
With Ratchet
(bullet holding forceps)

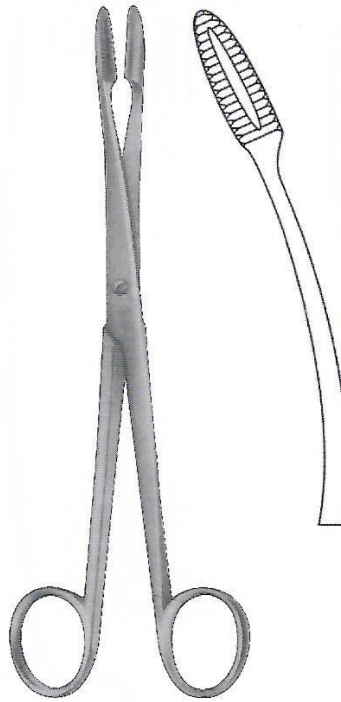

Gross Maier Dressing Forceps
F6-285 26.5cm, 10 1/2" curved
Without Ratchet
(bullet holding forceps)

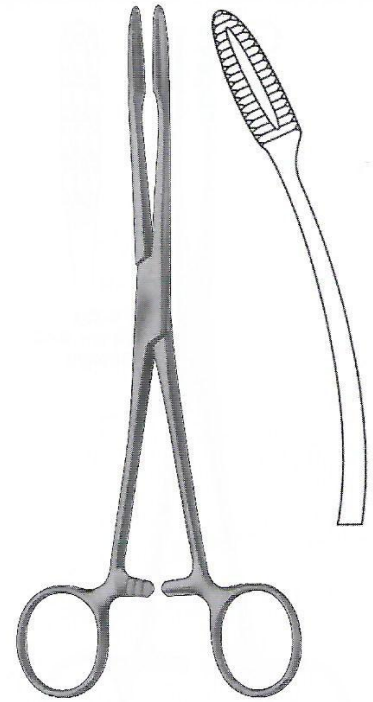

Gross Maier Dressing Forceps
F6-286 26.5cm, 10 1/2" curved
With Ratchet
(bullet holding forceps)

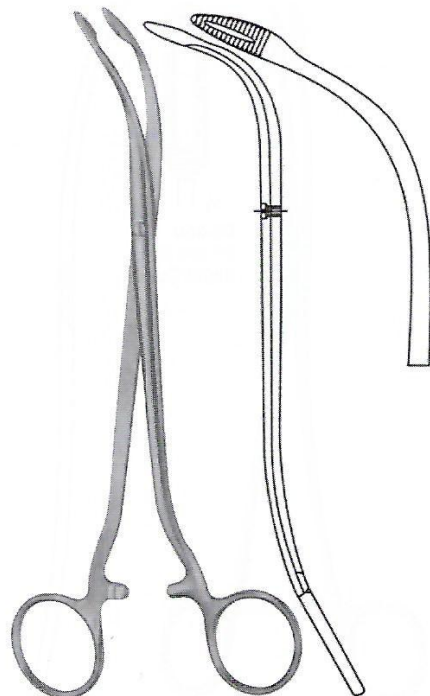

Duplay Sponge & Dressing Forceps
F6-287 19cm, 7 1/2"
Slight Curve

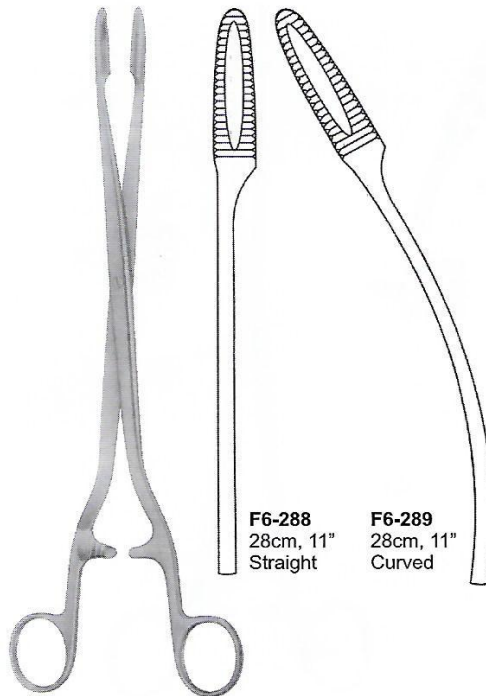

F6-288
28cm, 11"
Straight

F6-289
28cm, 11"
Curved

Sims-Maier Sponge & Dressing Forceps

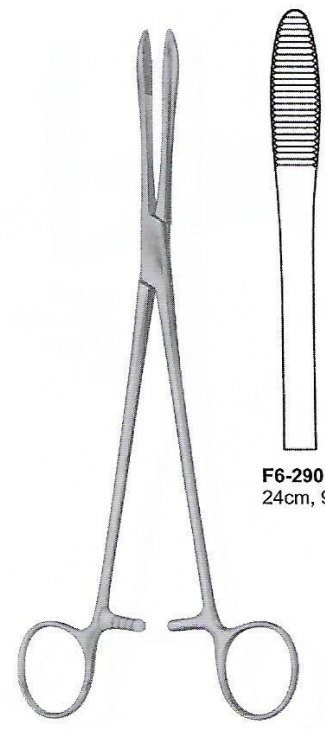

F6-290
24cm, 9 1/2"

Collin Sponge & Dressing Forceps



HAEMOSTATIC FORCEPS

Arterienklemmen
Pinces Hemostatiques

Pinzas Hemostaticas
Pinze Emostatiche

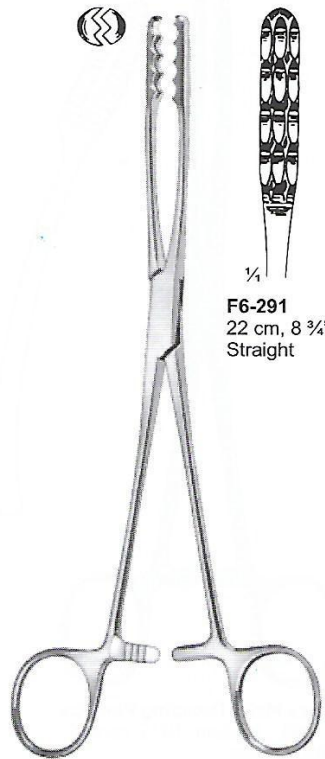

F6-291
22 cm, 8 3/4"
Straight

Ulrich Sponge Forceps



F6-292
25 cm, 10"
F6-293
27 cm, 11"
Straight

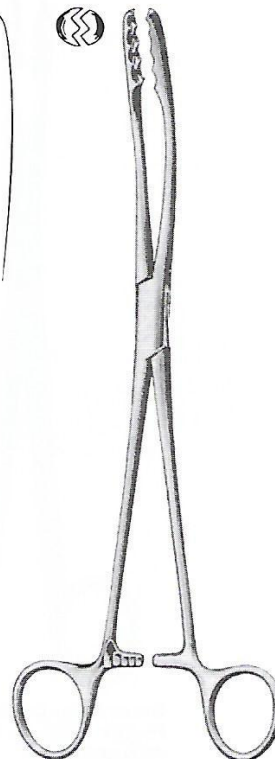
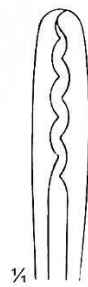

F6-294
22 cm, 8 3/4"
Curved

Ulrich Sponge Forceps



F6-295
25 cm, 10"
F6-296
27 cm, 11"
Curved



F6-297
22cm, 9 3/4"
Straight

Aesculap Sponge &
Dressing Forceps



F6-298
22cm, 9 3/4"
Curved

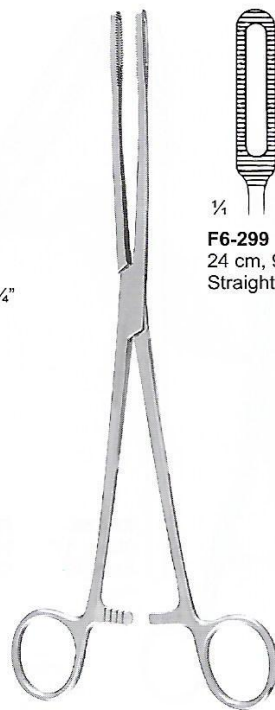

F6-299
24 cm, 9 1/2"
Straight

Fletcher Sponge Forceps

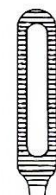

F6-300
24 cm, 9 1/2"
Slight Curve

Fletcher Sponge Forceps

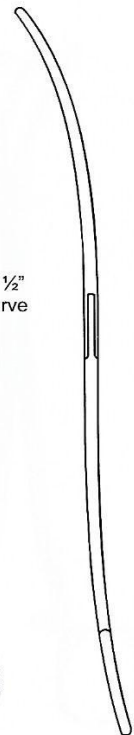

HAEMOSTATIC FORCEPS



Arterienklemmen
Pinces Hemostatiques

Pinzas Hemostaticas
Pinze Emostatiche

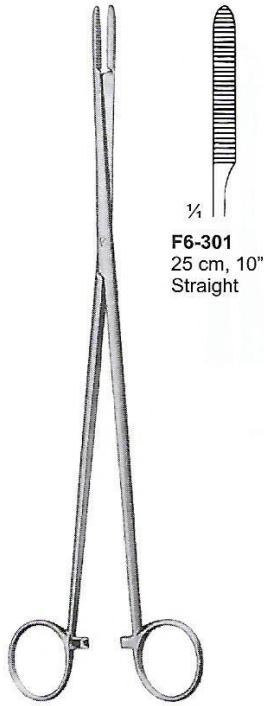

F6-301
25 cm, 10"
Straight

Pelkmann Sponge Forceps

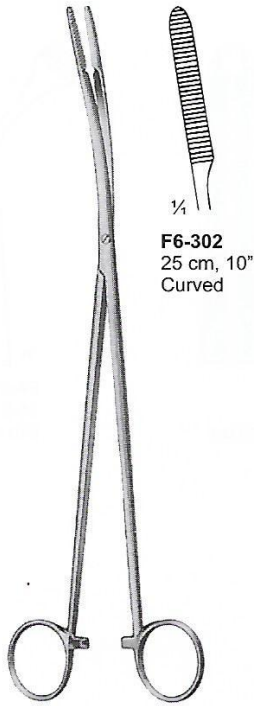

F6-302
25 cm, 10"
Curved

Pelkmann Sponge Forceps

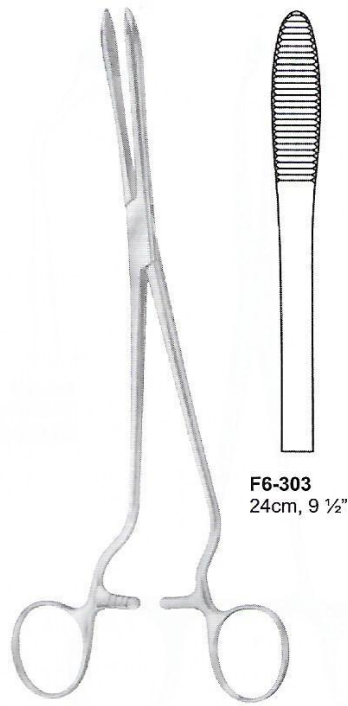

F6-303
24cm, 9 1/2"

Cheron Forceps
Handles Laterally
Angled

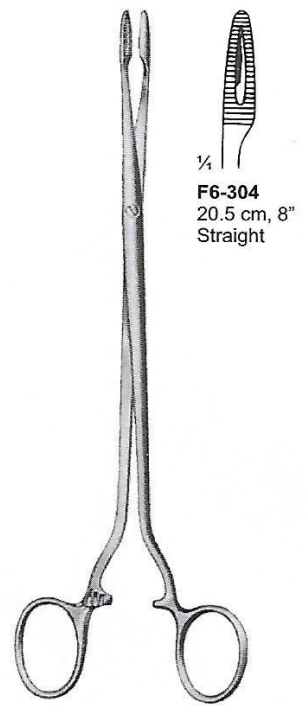

F6-304
20.5 cm, 8"
Straight

Duplay Sponge Forceps

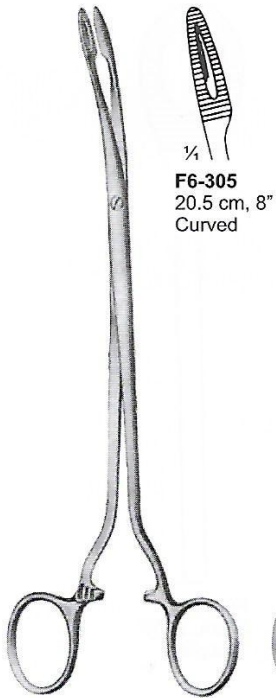

F6-305
20.5 cm, 8"
Curved

Duplay Sponge Forceps



**Heywood Smith
Sponge Forceps**
F6-306 25 cm, 10"

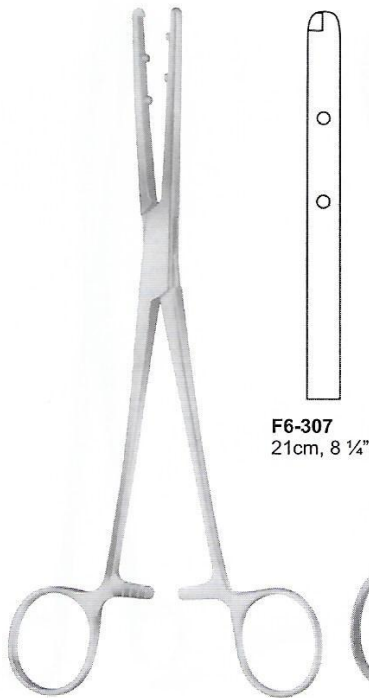

F6-307
21cm, 8 1/4"

**Emmet Sponge &
Dressing Forceps**

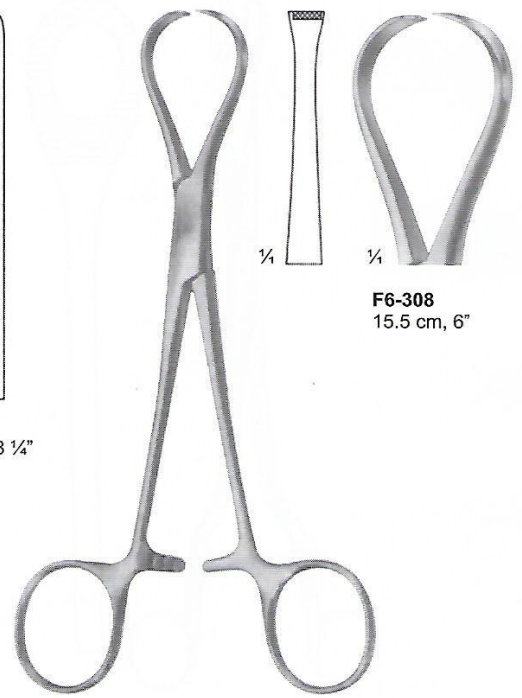

F6-308
15.5 cm, 6"

Tendon Seizing Forceps



HAEMOSTATIC FORCEPS

Arterienklemmen
Pinces Hemostatiques

Pinzas Hemostaticas
Pinze Emostatiche



Herz Tendon Seizing Forceps

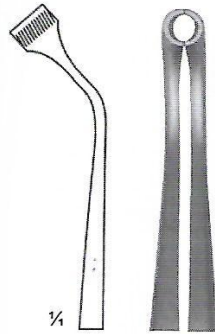

F6-309
15.5 cm, 6"
coarse serration

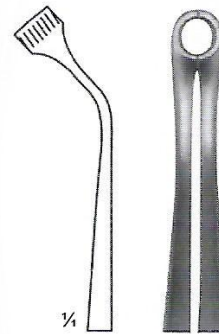

F6-310
15.5 cm, 6"
fine serrations

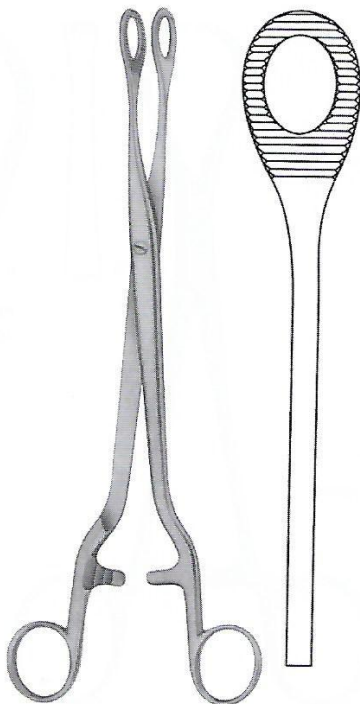

**Noto Sponge &
Dressing Forceps**
F6-311 28cm, 11"

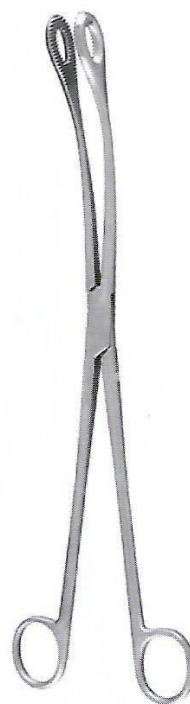

**Kelly Sponge &
Dressing Forceps**

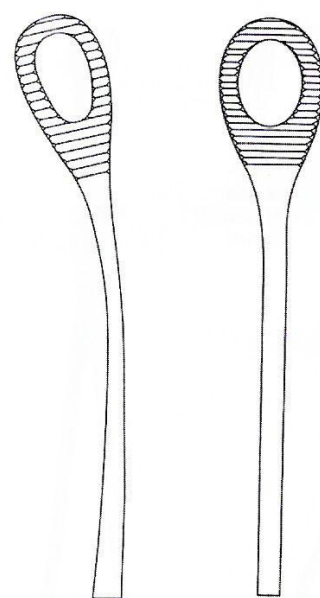

F6-312
32cm, 12 1/2"
Curved

F6-313
32cm, 12 1/2"
Straight

HAEMOSTATIC FORCEPS



Arterienklemmen
Pinces Hemostatiques

Pinzas Hemostaticas
Pinze Emostatiche

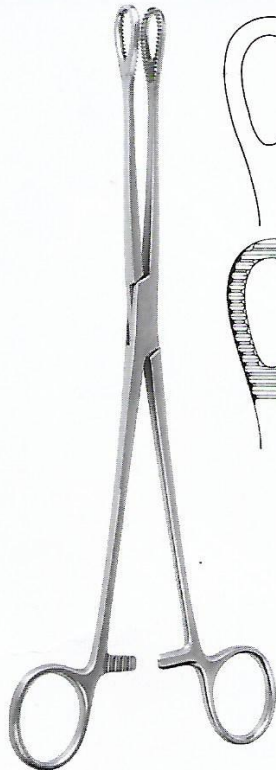

Foerster-Ballenger Sponge Forceps
& (bullet holding forceps)

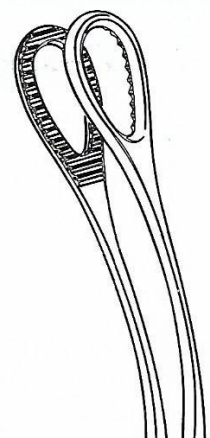
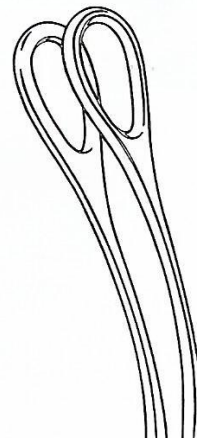
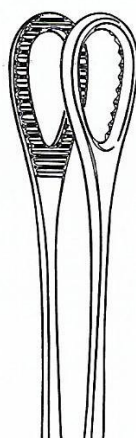
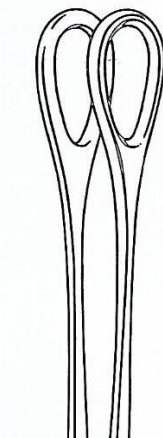

F6-314 18cm, 7"
F6-315 20.3cm, 8"
F6-316 24.1cm, 9.5"
Straight Smooth

F6-317 18cm, 7"
F6-318 20.3cm, 8"
F6-319 24.1cm, 9.5"
Straight Serrated

F6-320 18cm, 7"
F6-321 20.3cm, 8"
F6-322 24.4cm, 9.5"
Curved Smooth

F6-323 18cm, 7"
F6-324 20.3cm, 8"
F6-325 24.1cm, 9.5"
Curved Serrated

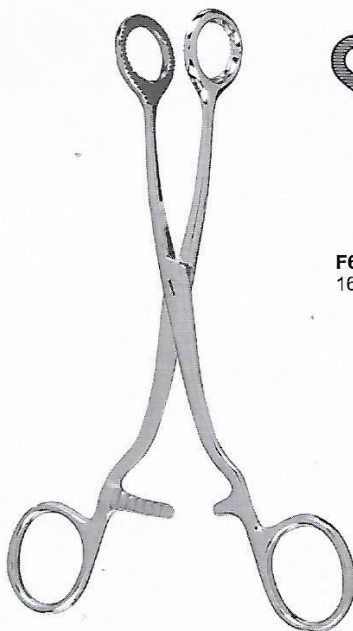

Collin Sponge & Dressing Forceps



F6-326
16cm, 6 1/4"



F6-327
16cm, 6 1/4"



F6-328
17cm, 6 3/4"

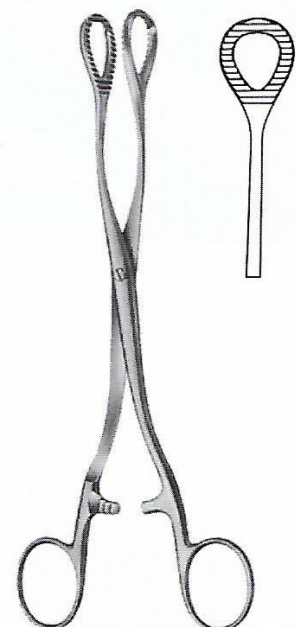

Heywood-Smith Sponge & Dressing Forceps
F6-329 20cm, 8"



NEEDLE HOLDERS

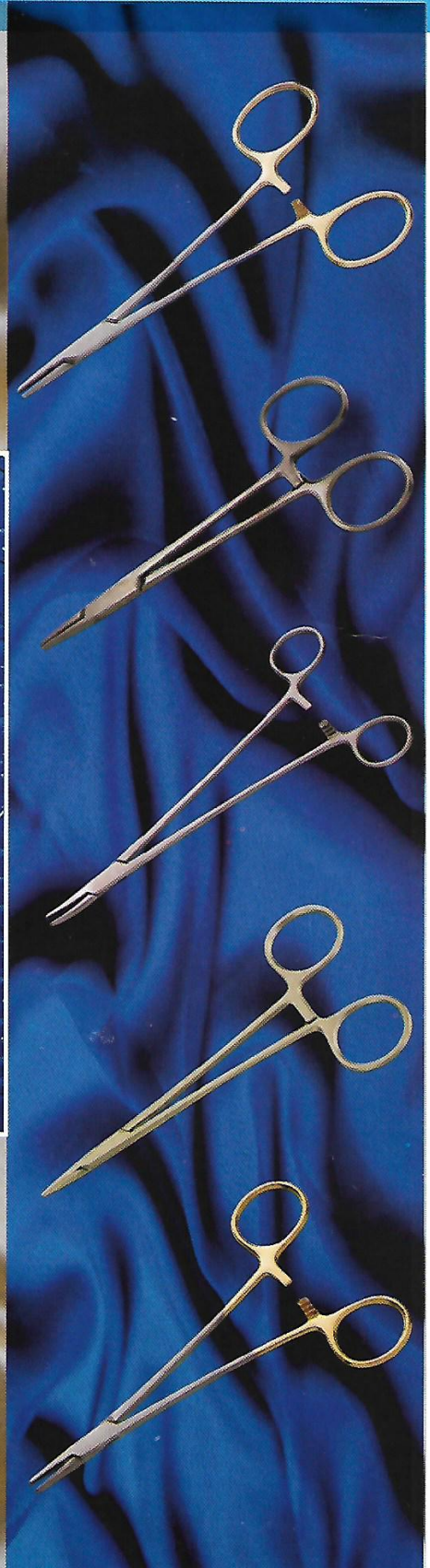
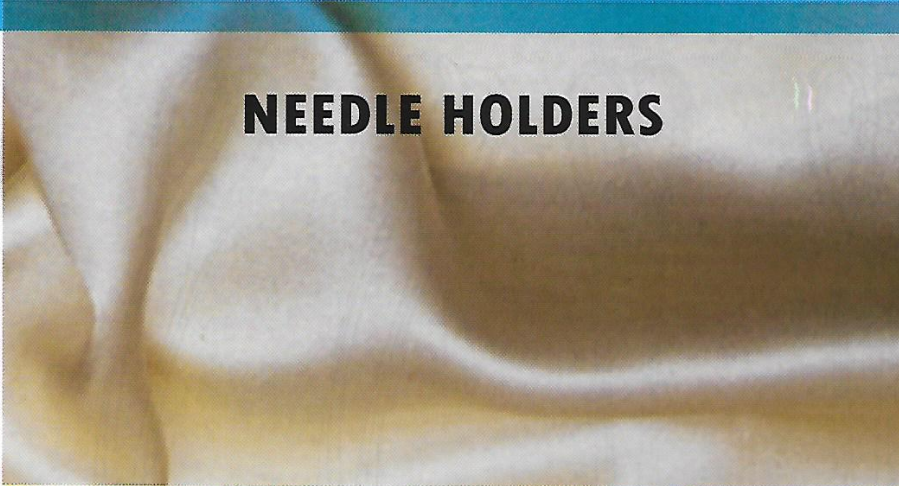

NEEDLE HOLDERS



Nadelhalter | Porta-agujas
 Prote-aiguilles | Porta aghi

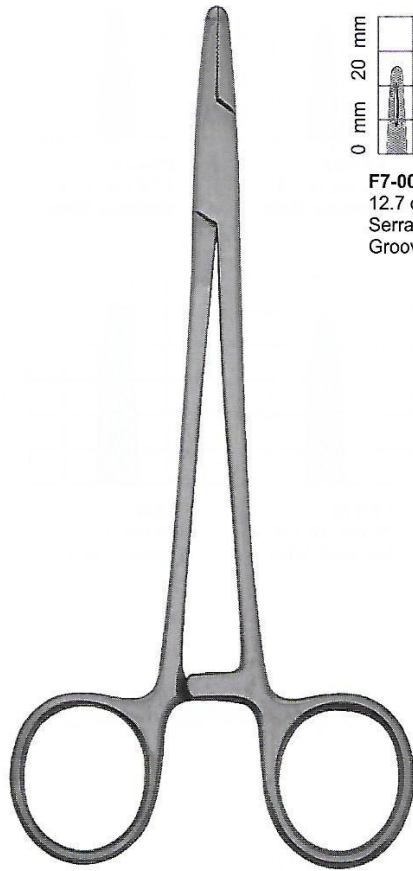

Mayo-Hegar
Needle Holders

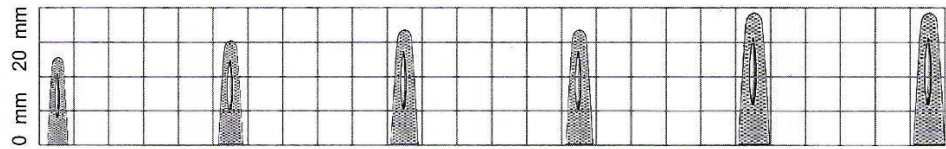

- | | | | | | |
|------------------------------------------------------|--------------------------------------------------------|------------------------------------------------------|---------------------------------------------------------------------|----------------------------------------------------------|-------------------------------------------------------------------------|
| F7-001
12.7 cm, 5"
Serrated-
Grooved | F7-002
14 cm, 5 1/2"
Serrated-
Grooved | F7-003
15.2 cm, 6"
Serrated-
Grooved | F7-004
15.2 cm, 6"
Serrated-
Grooved
left handed | F7-005
17.8 cm, 6 1/4"
Serrated-
Grooved | F7-006
17.8 cm, 6 1/4"
Serrated-
Grooved
left handed |
|------------------------------------------------------|--------------------------------------------------------|------------------------------------------------------|---------------------------------------------------------------------|----------------------------------------------------------|-------------------------------------------------------------------------|

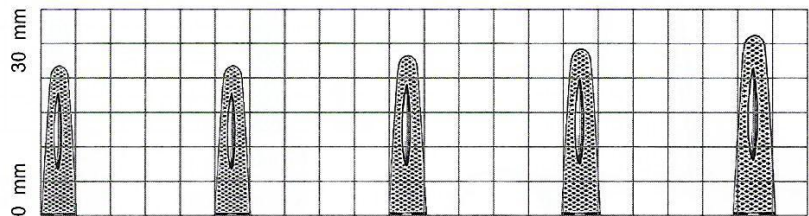

- | | | | | |
|------------------------------------------------------|---------------------------------------------------------------------|----------------------------------------------------------|---------------------------------------------------------|-------------------------------------------------------|
| F7-007
20.3 cm, 8"
Serrated-
Grooved | F7-008
20.3 cm, 8"
Serrated-
Grooved
left handed | F7-009
24.8 cm, 9 3/4"
Serrated-
Grooved | F7-010
26 cm, 10 1/4"
Serrated-
Grooved | F7-011
30.5 cm, 12"
Serrated-
Grooved |
|------------------------------------------------------|---------------------------------------------------------------------|----------------------------------------------------------|---------------------------------------------------------|-------------------------------------------------------|

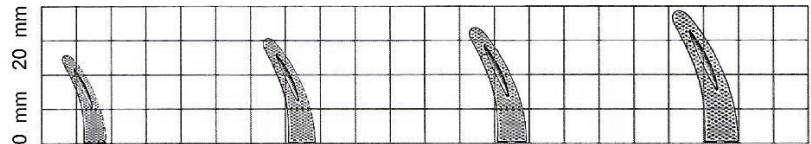

- | | | | |
|----------------------------------------------------------------|------------------------------------------------------------------|--------------------------------------------------------------------|----------------------------------------------------------------|
| F7-012
12.7 cm, 5"
Serrated-
Grooved
Curved | F7-013
14 cm, 5 1/2"
Serrated-
Grooved
Curved | F7-014
15.2 cm, 6 1/4"
Serrated-
Grooved
Curved | F7-015
17.8 cm, 7"
Serrated-
Grooved
Curved |
|----------------------------------------------------------------|------------------------------------------------------------------|--------------------------------------------------------------------|----------------------------------------------------------------|

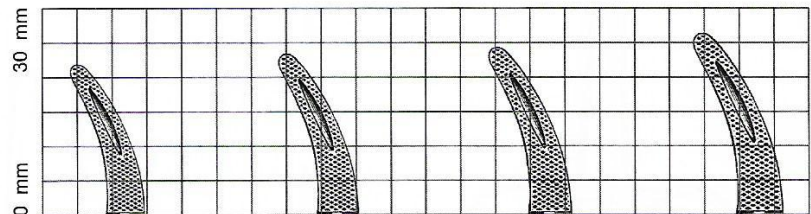

- | | | | |
|----------------------------------------------------------------|--------------------------------------------------------------------|-------------------------------------------------------------------|-----------------------------------------------------------------|
| F7-016
20.3 cm, 8"
Serrated-
Grooved
Curved | F7-017
24.8 cm, 9 3/4"
Serrated-
Grooved
Curved | F7-018
26 cm, 10 1/4"
Serrated-
Grooved
Curved | F7-019
30.5 cm, 12"
Serrated-
Grooved
Curved |
|----------------------------------------------------------------|--------------------------------------------------------------------|-------------------------------------------------------------------|-----------------------------------------------------------------|



NEEDLE HOLDERS

Nadelhalter | Porta-agujas

Prote-aiguilles | Porta aghi



BAUMGARTNER
Needle Holder

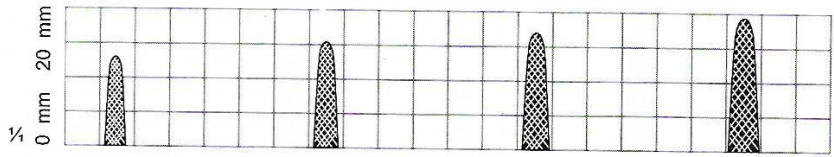

F7-020
12.7 cm, 5"
Serrated-Solid

F7-021
14 cm, 5 1/2"
Serrated-Solid

F7-022
16 cm, 6 1/4"
Serrated-Solid

F7-023
17.8 cm, 7"
Serrated-Solid

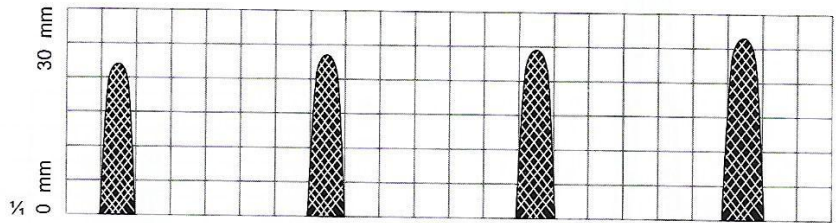

F7-024
20.3 cm, 8"
Serrated-Solid

F7-025
24.8 cm, 9 3/4"
Serrated-Solid

F7-026
26 cm, 10 1/4"
Serrated-Solid

F7-027
30.5 cm, 12"
Serrated-Solid

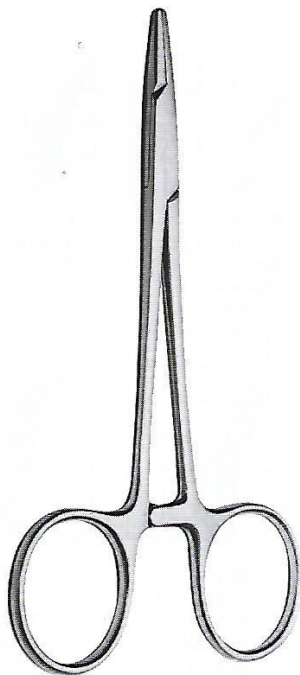

WEBSTER
Needle Holder

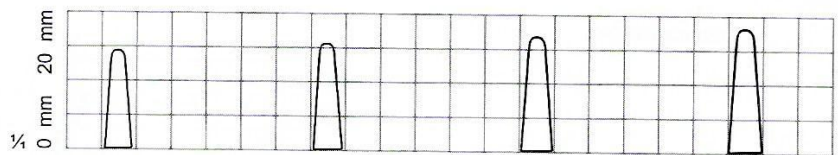

F7-028
11.4 cm, 4 1/2"
Smooth

F7-029
12 cm, 4 3/4"
Smooth

F7-030
12.7 cm, 5"
Smooth

F7-031
13.3 cm, 5 1/4"
Smooth

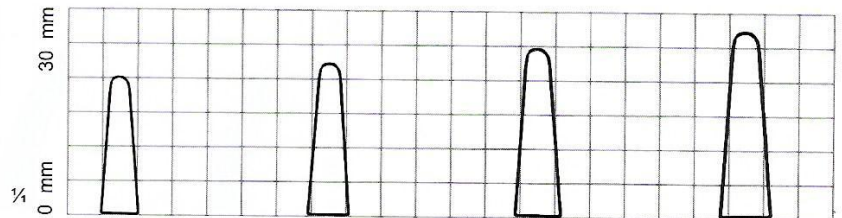

F7-032
14 cm, 5 1/2"
Smooth

F7-033
15.2 cm, 6"
Smooth

F7-034
17.8 cm, 7"
Smooth

F7-035
20.3 cm, 8"
Smooth

NEEDLE HOLDERS



Nadelhalter | Porta-agujas
 Prote-aiguilles | Porta aghi



BROWN
Needle Holder

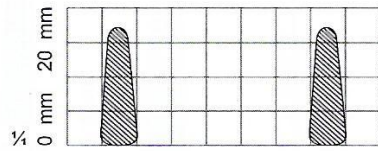

F7-036
13.3 cm, 5 1/4"
Serrated-Solid

F7-037
19.1 cm, 7 1/2"
Serrated-Solid



BABY CRILE-WOOD
Needle Holder

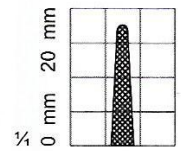

F7-038
15 cm, 6"

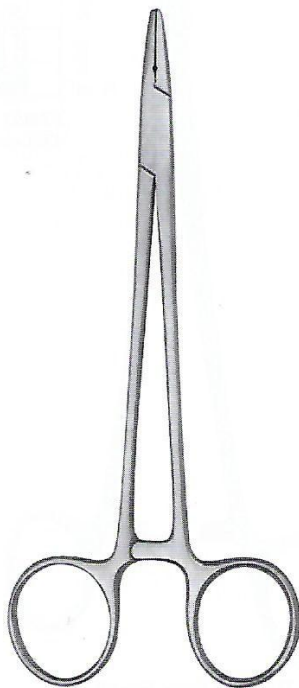

CRILE-WOOD
Needle Holder

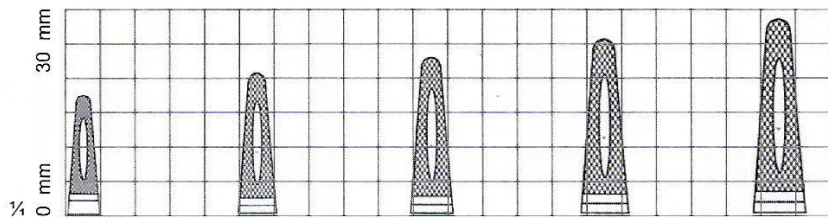

F7-039
15.2 cm, 6"
grooved serrated

F7-040
17.8 cm, 7"
grooved serrated

F7-041
20.3 cm, 8"
grooved serrate

F7-042
22.3 cm, 8 3/4"
grooved serrated

F7-043
25.4 cm, 10"
grooved serrated

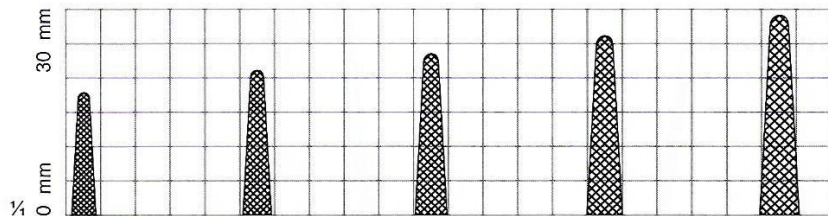

F7-044
15.2 cm, 6"
solid serrated

F7-045
17.8 cm, 7"
solid serrated

F7-046
20.3 cm, 8"
solid serrated

F7-047
22.3 cm, 8 3/4"
solid serrated

F7-048
25.4 cm, 10"
solid serrated



NEEDLE HOLDERS

Nadelhalter | Porta-agujas
Prote-aiguilles | Porta aghi

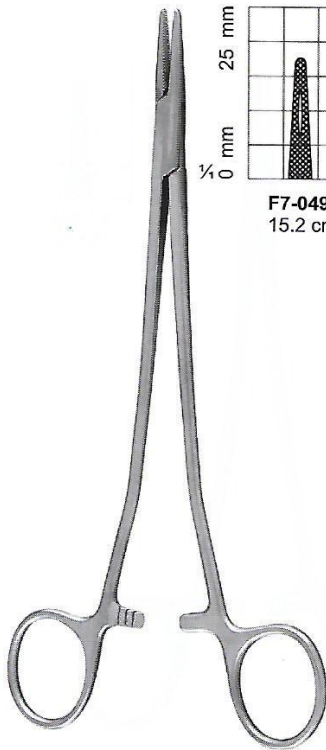

Sarot Needle Holders

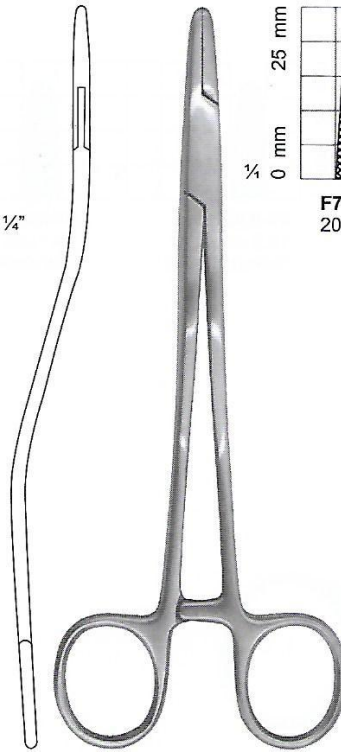
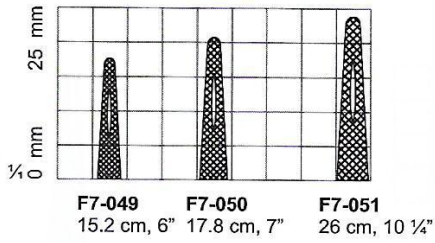

Bozemann Needle Holders

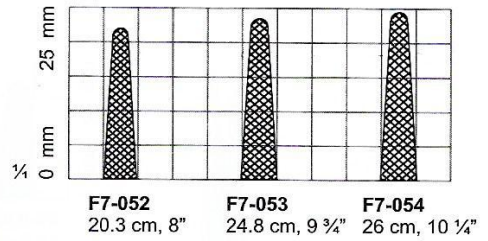

Jameson Needle Holders

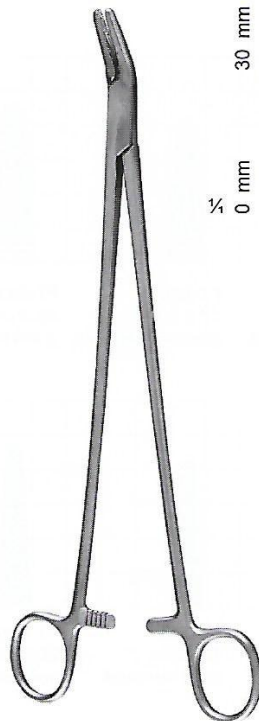
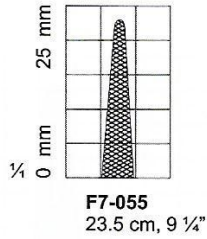

Finocchietto Needle Holders

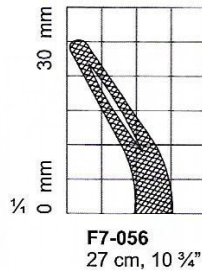

Mass. General Hospital
Needle Holders

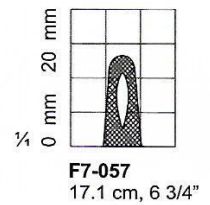

NEEDLE HOLDERS

Nadelhalter | Porta-agujas
 Prote-aiguilles | Porta aghi



F7-058
 17.8 cm, 7"

Adson Needle Holders



F7-059
 18 cm, 7"

New Orleans Needle Holders

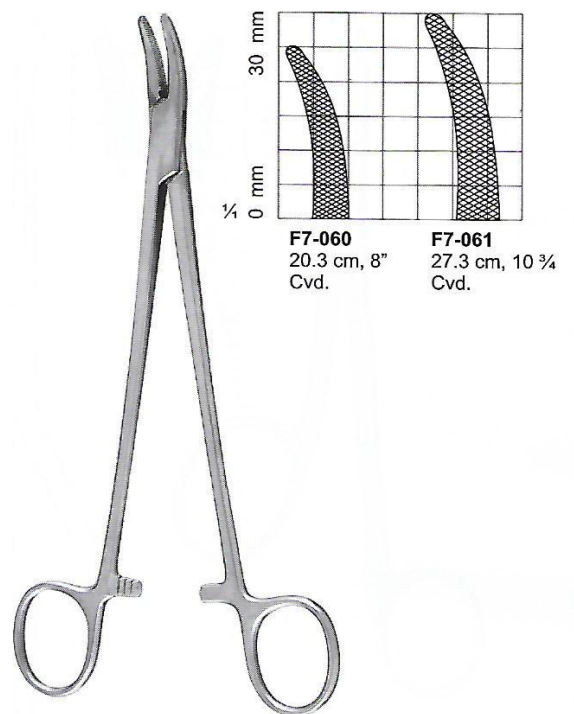

F7-060
 20.3 cm, 8"
 Cvd.

F7-061
 27.3 cm, 10 1/4"
 Cvd.

Heaney Needle Holders
 07-165

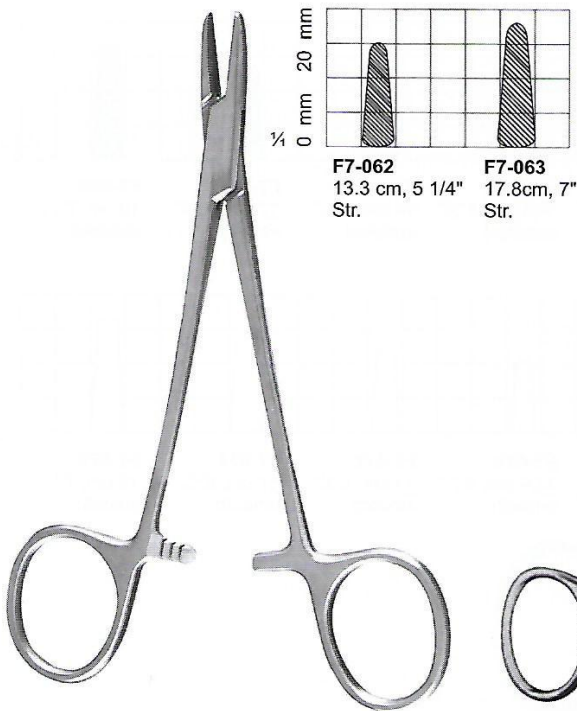

F7-062
 13.3 cm, 5 1/4"
 Str.

F7-063
 17.8cm, 7"
 Str.

Brown Needle Holders

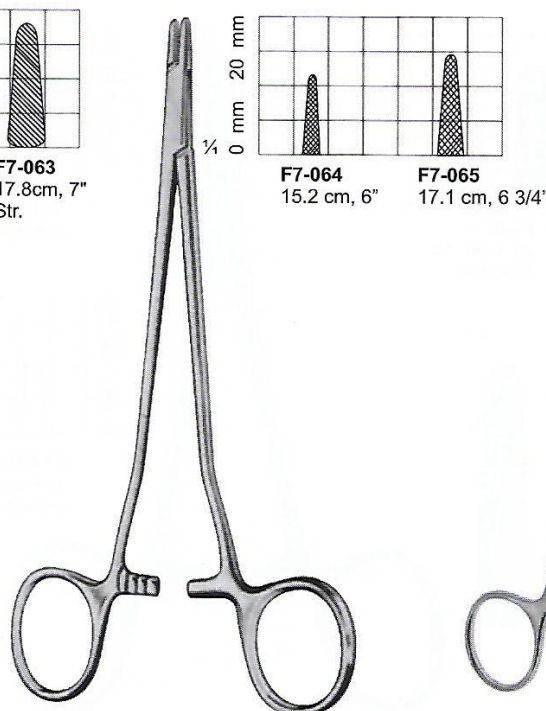

F7-064
 15.2 cm, 6"

F7-065
 17.1 cm, 6 3/4"

Senning Needle Holders
 (Schwed. Model)

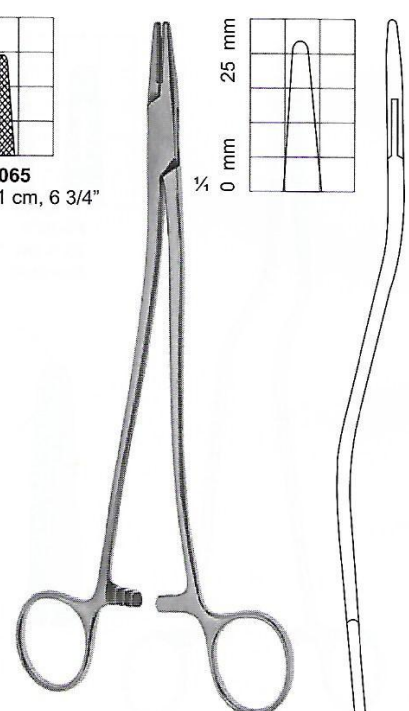

Wertheim Needle Holders
F7-066 20 cm, 8"
F7-067 24 cm, 9 1/2"



NEEDLE HOLDERS

Nadelhalter | Porta-agujas
 Prote-aiguilles | Porta aghi

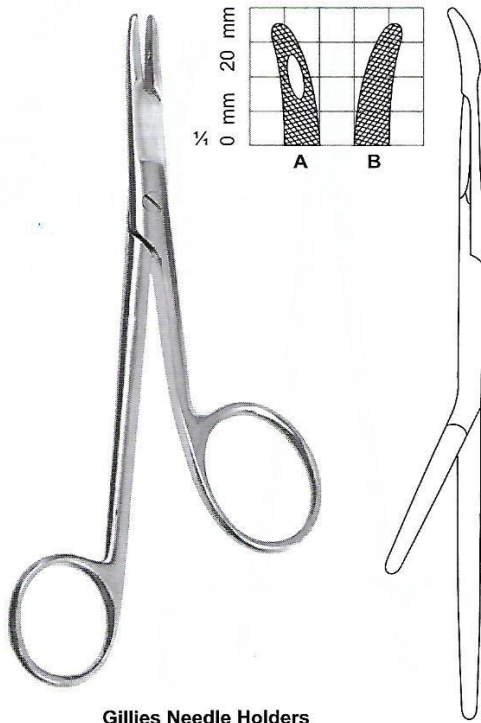

Gillies Needle Holders
F7-068
 16 cm, 6 1/4"

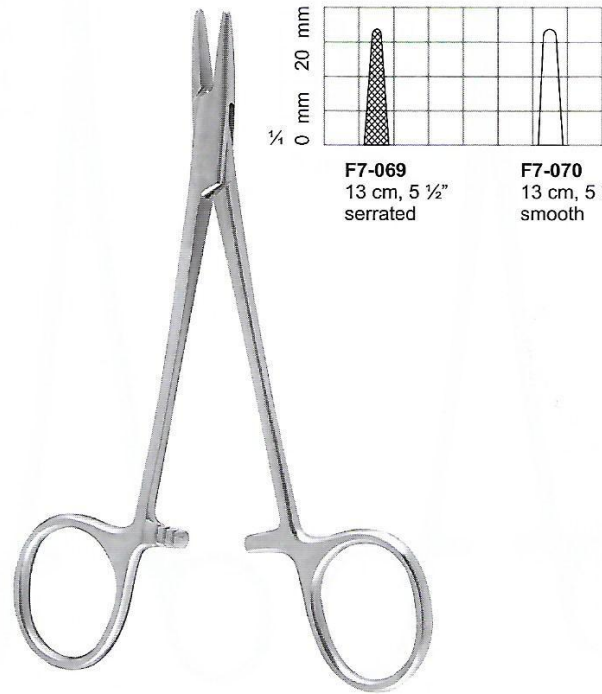

Halsey Needle Holders

F7-069
 13 cm, 5 1/2"
 serrated

F7-070
 13 cm, 5 1/2"
 smooth

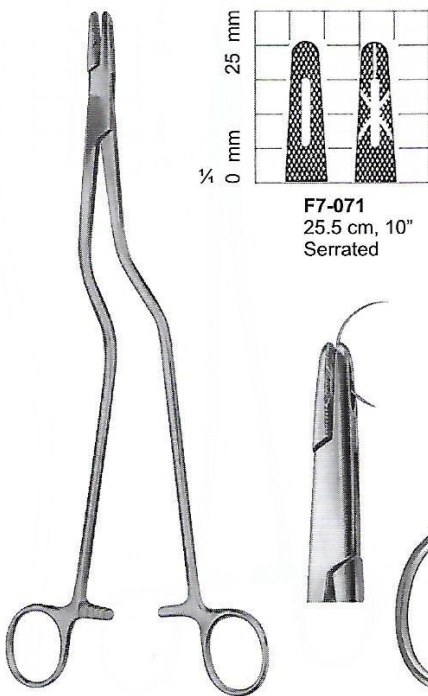

Masson-Luethy
Needle Holders

F7-071
 25.5 cm, 10"
 Serrated

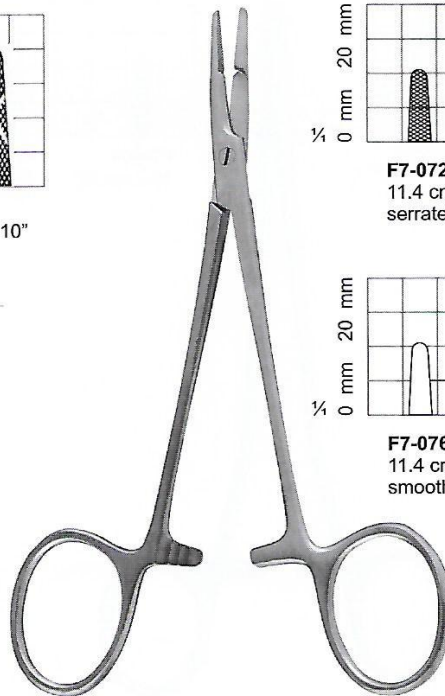

Olsen-Hegar Needle Holders

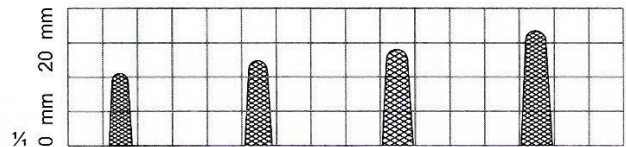

F7-072
 11.4 cm, 4 1/2"
 serrated

F7-073
 14 cm, 5 1/2"
 serrated

F7-074
 17 cm, 6 3/4"
 serrated

F7-075
 19 cm, 7 1/2"
 serrated

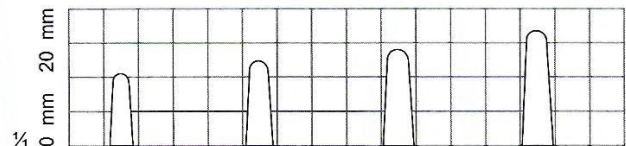

F7-076
 11.4 cm, 4 1/2"
 smooth

F7-077
 14 cm, 5 1/2"
 smooth

F7-078
 17 cm, 6 3/4"
 smooth

F7-079
 19 cm, 7 1/2"
 smooth

NEEDLE HOLDERS



Nadelhalter | Porta-agujas
 Prote-aiguilles | Porta aghi

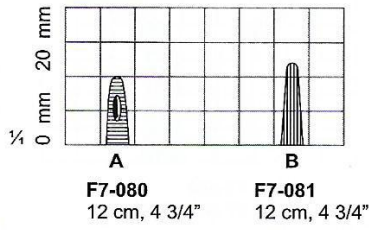
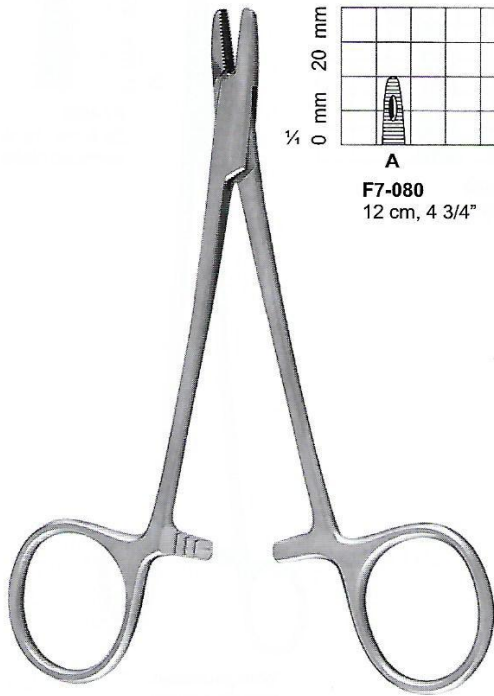

Derf Needle Holders

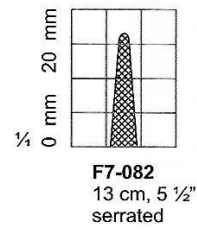
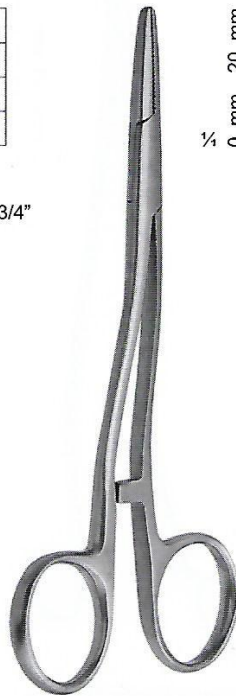

Kilner Needle Holders

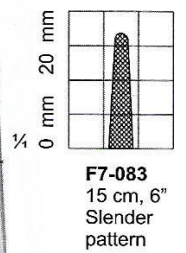
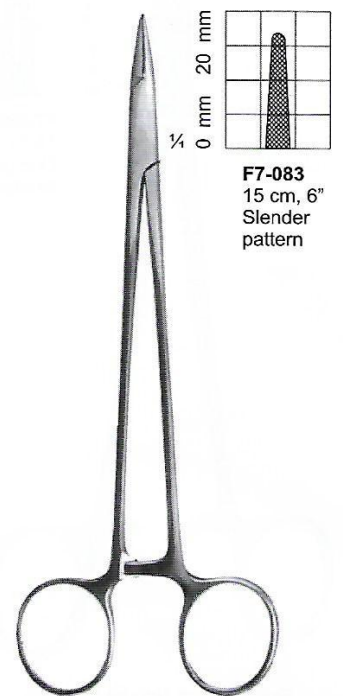

Crile-Murray
 Needle Holders

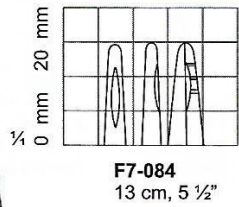
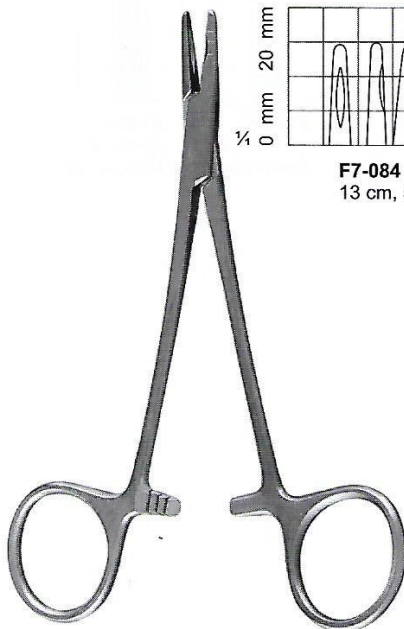

Neivert Needle Holders

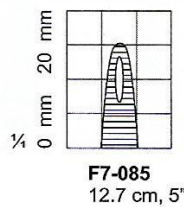
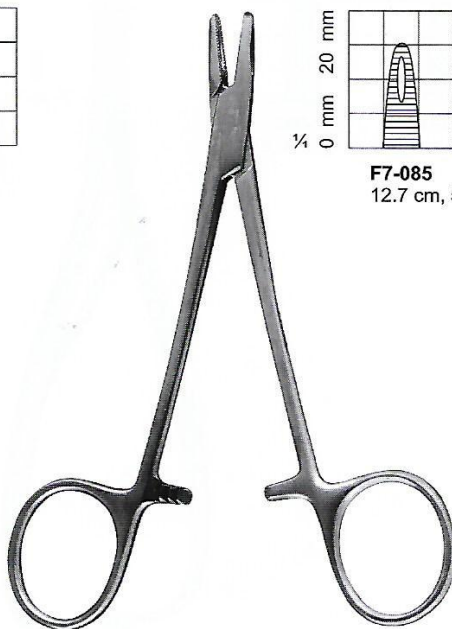

Collier Needle Holders

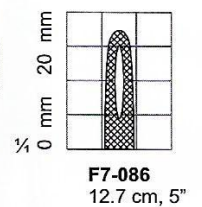
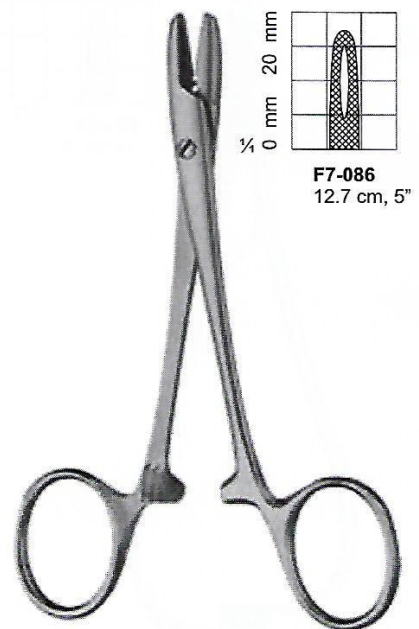

Doyen Needle Holders



NEEDLE HOLDERS

Nadelhalter | Porta-agujas
Prote-aiguilles | Porta aghi

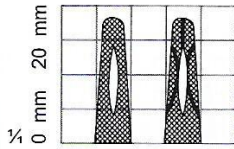

F7-087
18.5 cm, 7 1/4"
One grooved and fenestrated jaw

Metzenbaum Needle Holders

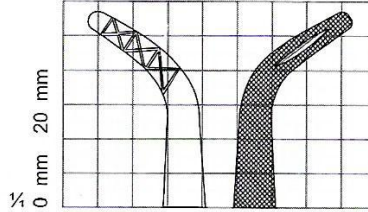
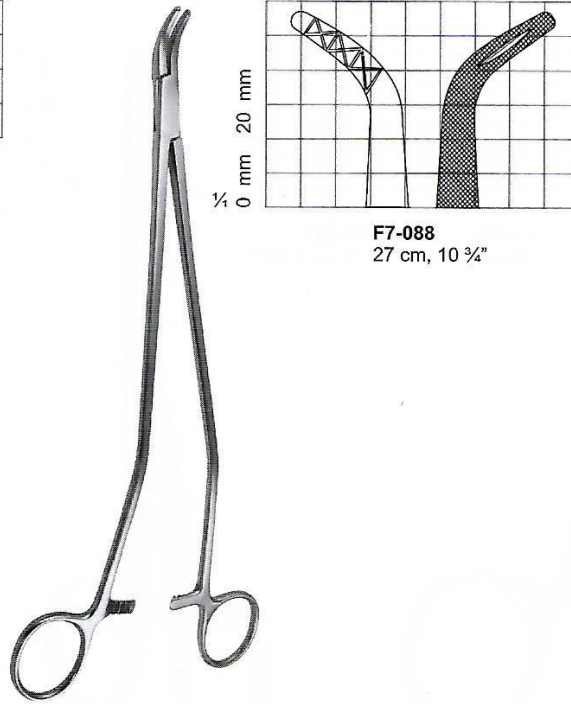

F7-088
27 cm, 10 3/4"

Johnson Needle Holders

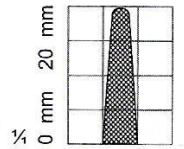

F7-089
26.5 cm, 10 1/2"
Serrated-Solid

Wangensteen Needle Holders

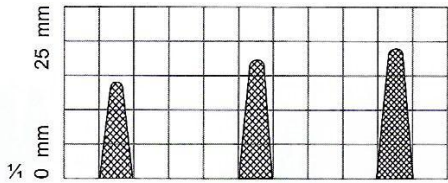
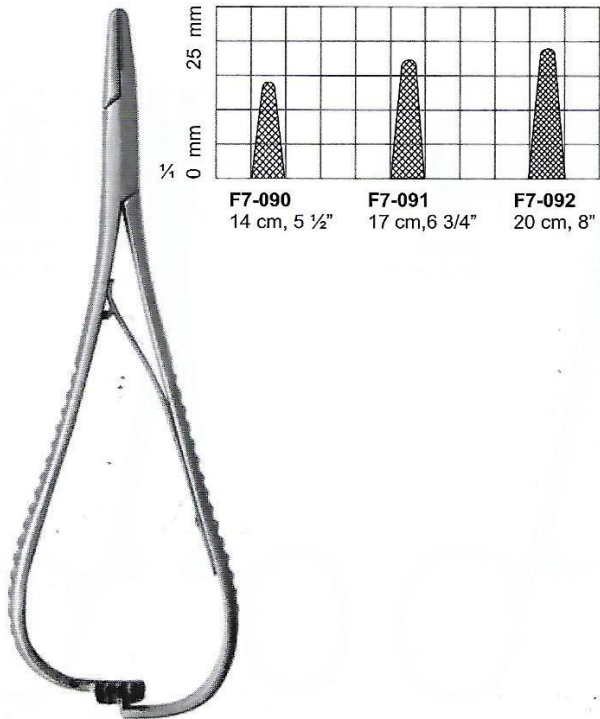

F7-090 14 cm, 5 1/2"
F7-091 17 cm, 6 3/4"
F7-092 20 cm, 8"

Mathieu Needle Holders

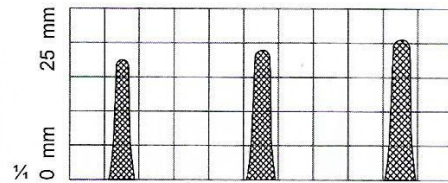
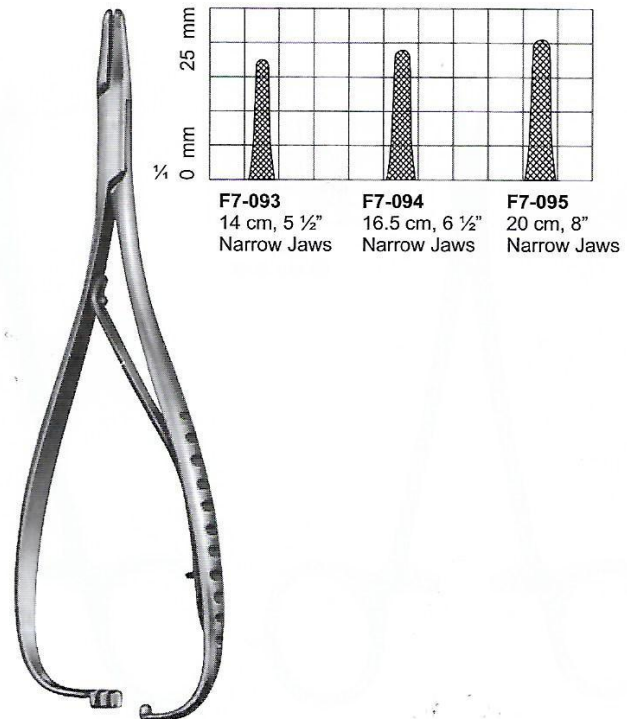

F7-093 14 cm, 5 1/2"
Narrow Jaws
F7-094 16.5 cm, 6 1/2"
Narrow Jaws
F7-095 20 cm, 8"
Narrow Jaws

Mathieu Needle Holders

NEEDLE HOLDERS



Nadelhalter | Porta-agujas
 Prote-aiguilles | Porta aghi

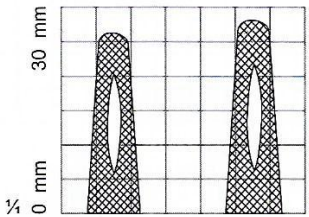
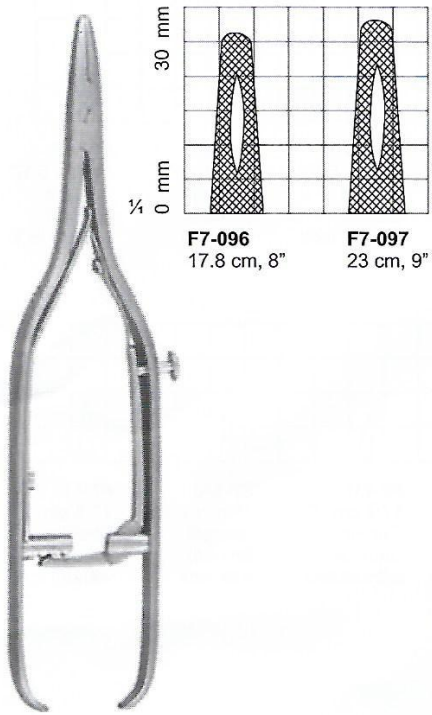

F7-096
17.8 cm, 8"
F7-097
23 cm, 9"

Mayo Rochester Needle Holders
button release, screw joint.

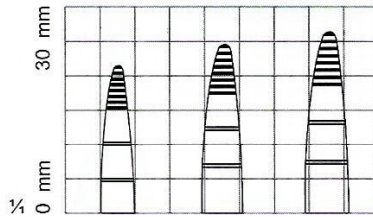

F7-098
15 cm, 6"
lined with copper.
F7-099
17.8 cm, 7"
lined with copper.
F7-100
20 cm, 8"
lined with copper.

Macphail Needle Holders

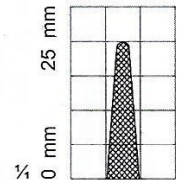
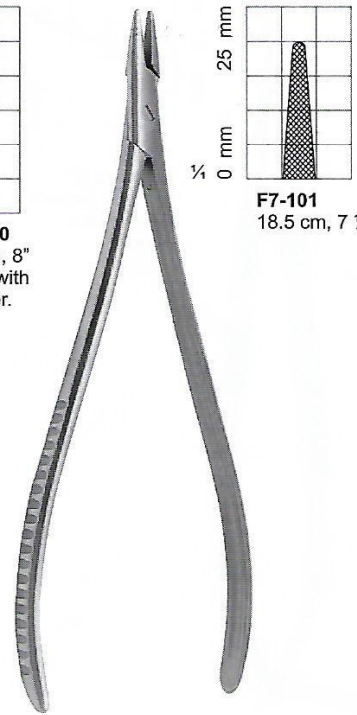

F7-101
18.5 cm, 7 1/4"

Tennis Needle Holders

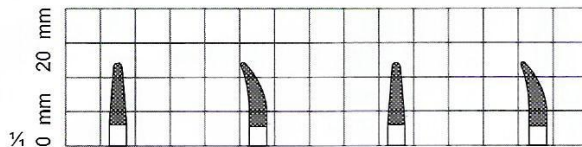
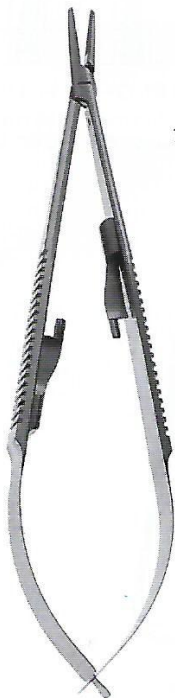

F7-102
12.7 cm, 5"
with lock
straight
F7-103
12.7 cm, 5"
with lock
curved
F7-104
12.7 cm, 5"
without lock
straight
F7-105
12.7 cm, 5"
without lock
curved

Castroviejo Needle Holders

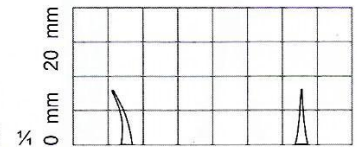

F7-106
14 cm, 5 1/2"
Curved, Smooth
with lock curved
F7-107
14 cm, 5 1/2"
Straight, Smooth
with lock curved

Barraquer Needle Holders



NEEDLE HOLDERS

Nadelhalter | Porta-agujas
 Prote-aiguilles | Porta aghi

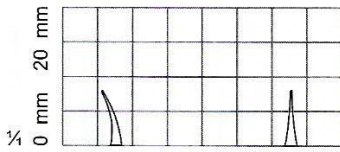

F7-108
 14 cm, 5 1/2"
 Curved, Smooth
 without lock

F7-109
 14 cm, 5 1/2"
 Straight, Smooth
 without lock
 curved

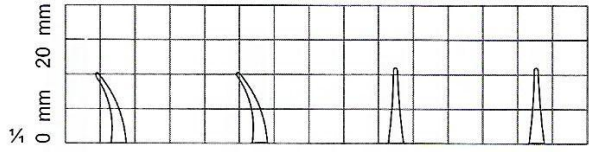
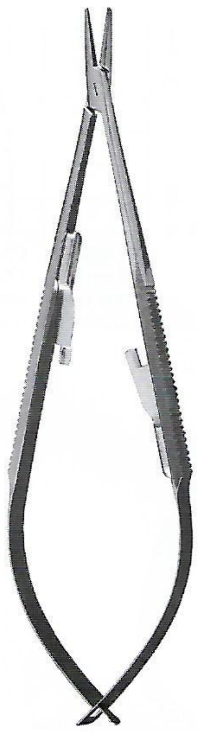

F7-110
 14 cm, 5 1/2"
 Curved
 Smooth
 with lock

F7-111
 14 cm, 5 1/2"
 Curved
 Smooth
 without lock

F7-112
 14 cm, 5 1/2"
 Straight
 Smooth
 with lock

F7-113
 14 cm, 5 1/2"
 Straight
 Smooth
 without lock

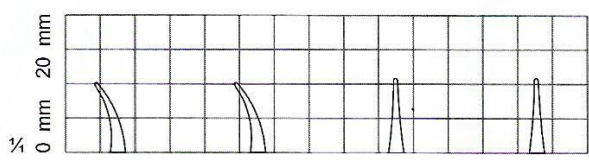

F7-114
 17.8 cm, 7"
 Curved
 Smooth
 with lock

F7-115
 17.8 cm, 7"
 Curved
 Smooth
 without lock

F7-116
 17.8 cm, 7"
 Straight
 Smooth
 with lock

F7-117
 17.8 cm, 7"
 Straight
 Smooth
 without lock

Barraquer Needle Holders

Castroviejo Needle Holders

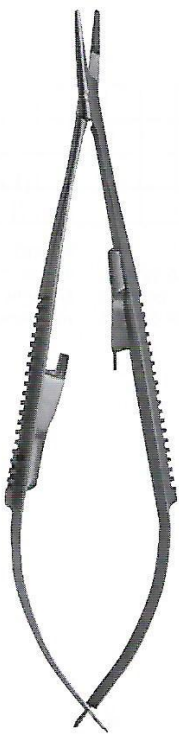

**Castroviejo Olsen Heager /
 Needle Holders / Scissors**
 F7-118 14.5 cm, 5 3/4"
 F7-119 15.0 cm, 6"

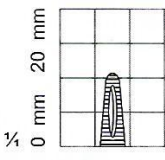
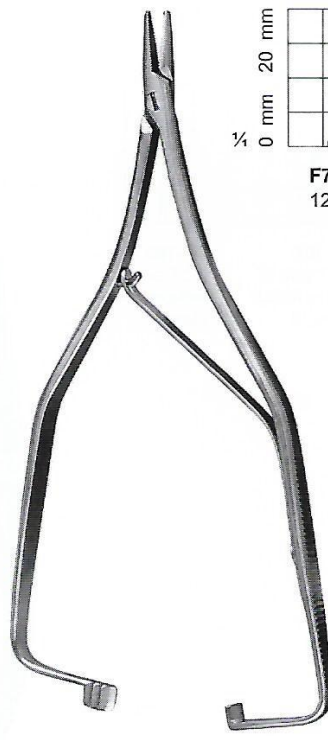

F7-120
 12 cm, 5"

Boynton Needle Holders

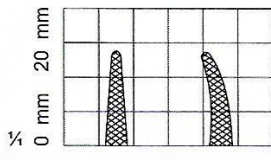

F7-121
 16 cm,
 6 1/4" Str.

F7-122
 16 cm,
 6 1/4" Cvd.

Arruga Needle Holders

NEEDLE HOLDERS



Nadelhalter | Porta-agujas
 Prote-aiguilles | Porta aghi

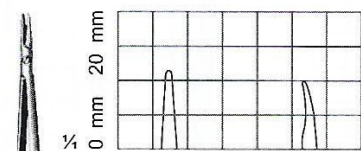

F7-123 19.5 cm, 7 3/4"
Smooth Str.

F7-124 23 cm, 9"
Smooth Cvd.

Micro Needle Holders

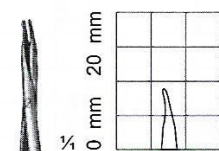

F7-125
16 cm, 6 1/4"
Smooth Cvd.

Micro Needle Holders

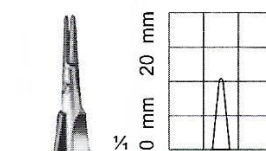

F7-126
12 cm, 5"
Smooth Str
with lock

Castroviejo Needle Holders

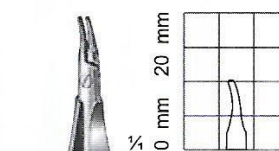

F7-127
12 cm, 5"
Smooth Cvd
with lock

Castroviejo Needle Holders

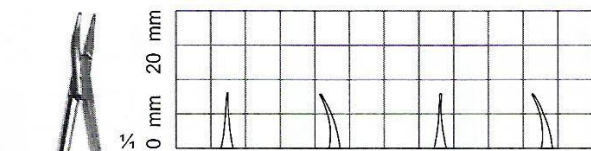

F7-128 10.5 cm, 4"
Smooth Str.

F7-129 10.5 cm, 4"
Smooth Cvd.

F7-130 11.5 cm, 4 3/4"
Smooth Str.

F7-131 11.5 cm, 4 3/4"
Smooth Cvd.

Barraquer-Trotman Needle Holders

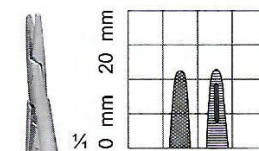

F7-132
13.5 cm, 5 1/4"
Serrated

Kalt Needle Holders

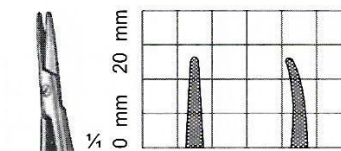

F7-133 13.5 cm, 5 1/4"
Serrated Str.

F7-134 13.5 cm, 5 1/4"
Serrated Cvd.

Arruga Needle Holders

NEEDLE HOLDERS T.C



Nadelhalter | Porta-agujas
 Prote-aiguilles | Porta aghi

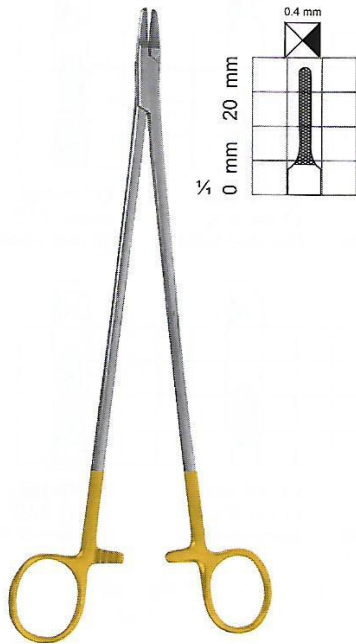

Intracardiac Needle Holders T.C.
 T.C F7-150 18 cm, 7"
 T.C F7-151 20 cm, 8"
 T.C F7-152 22 cm, 8 3/4"
 T.C F7-153 25 cm, 10"

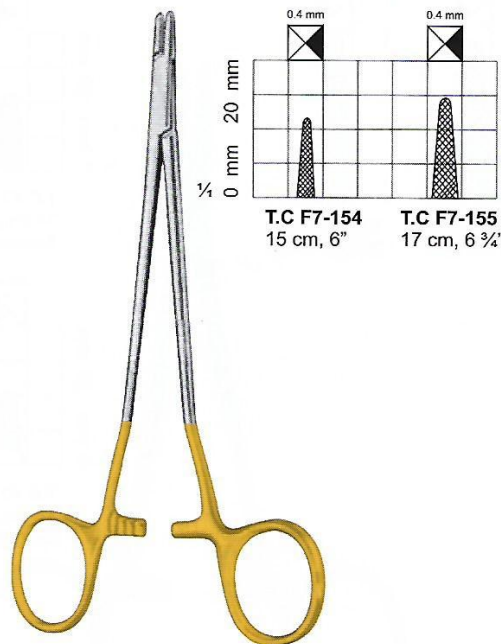

**Senning Needle Holders T.C
 (Schwed. Model)**

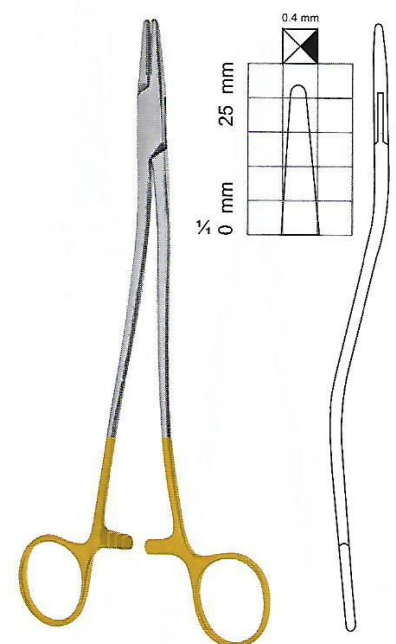

Wertheim Needle Holders T.C
 T.C F7-156 20 cm, 8"
 T.C F7-157 24 cm, 9 1/2"

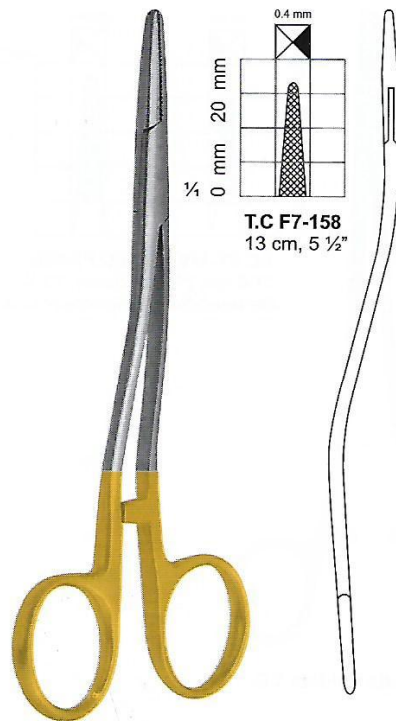

Kilner Needle Holders T.C

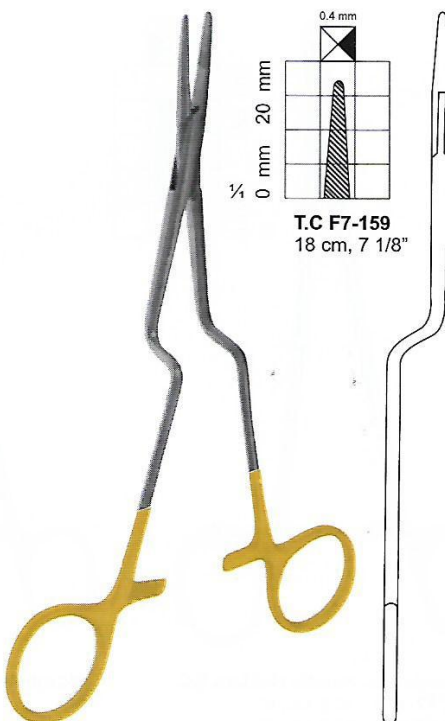

Jacobson Needle Holders T.C

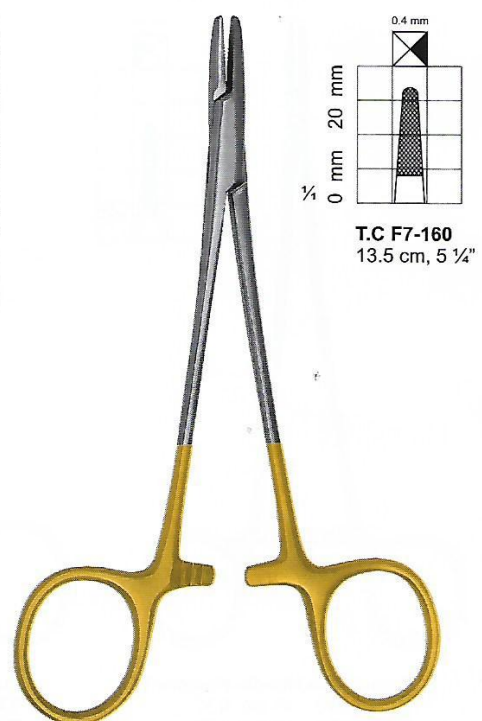

Baumgartner Needle Holders T.C



NEEDLE HOLDERS T.C

Nadelhalter | Porta-agujas
 Prote-aiguilles | Porta aghi

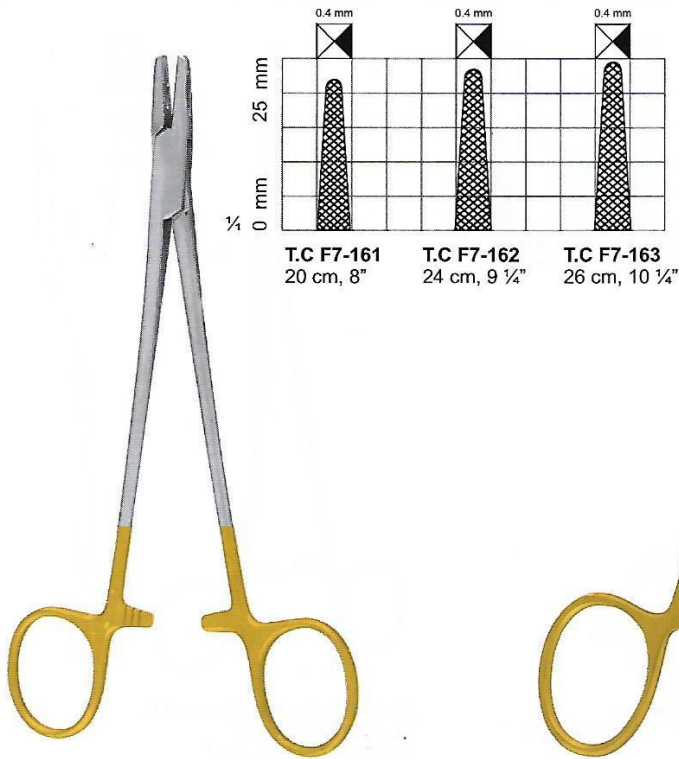

Bozemann Needle Holders T.C

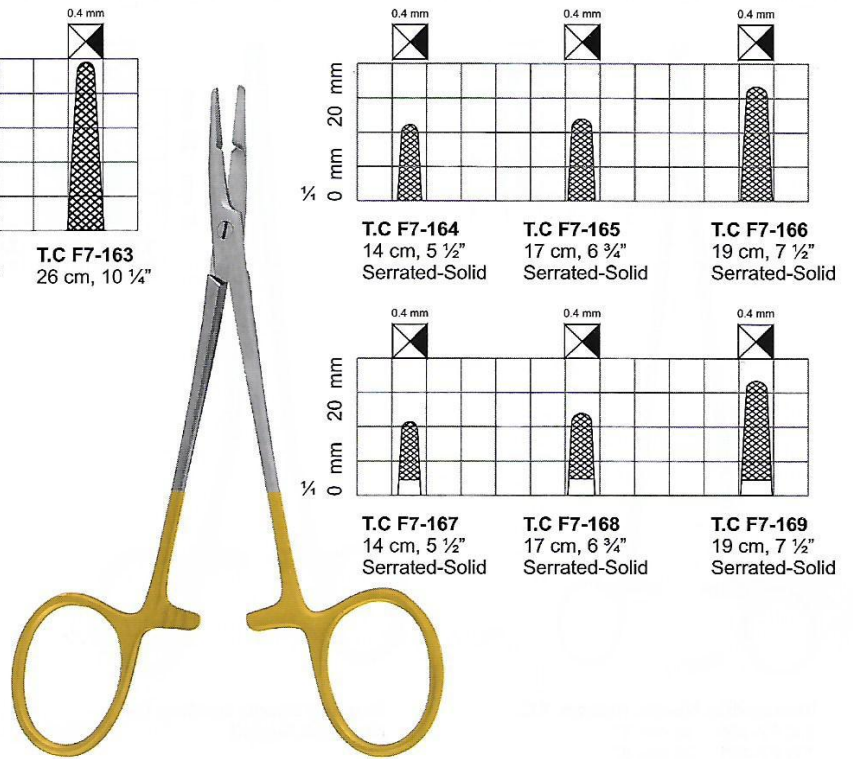

Olsen-Hegar Needle Holders T.C

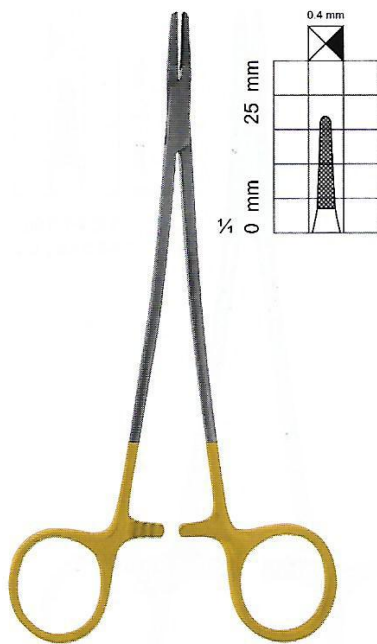

French-Eye Needle Holders T.C
 T.C F7-170 16 cm, 6 1/4"
 T.C F7-171 17.8 cm, 7"
 T.C F7-172 20 cm, 8"
 T.C F7-173 22 cm, 8 3/4"
 T.C F7-174 25 cm, 10"

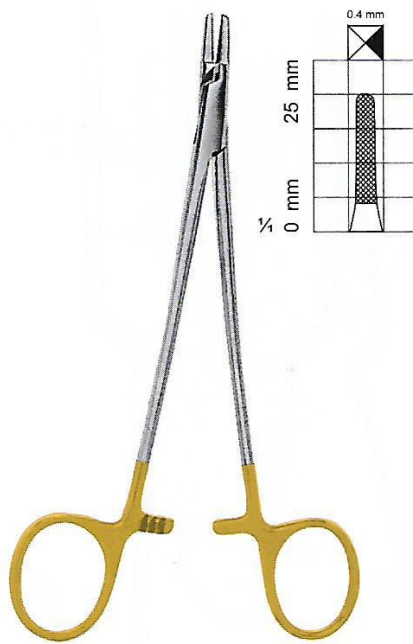

French-Eye Needle Holders T.C
 T.C F7-175 15.2 cm, 6"
 T.C F7-176 17.8 cm, 7"
 T.C F7-177 20.3 cm, 8"
 T.C F7-178 25.4 cm, 10"

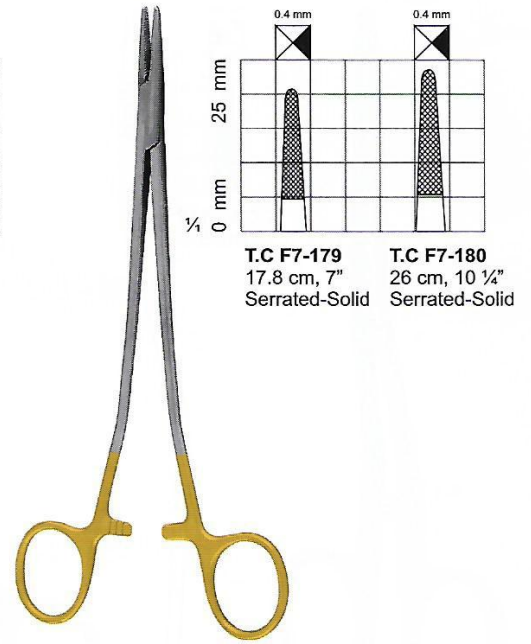

Sarot Needle Holders T.C

NEEDLE HOLDERS T.C



Nadelhalter | Porta-agujas
 Prote-aiguilles | Porta aghi

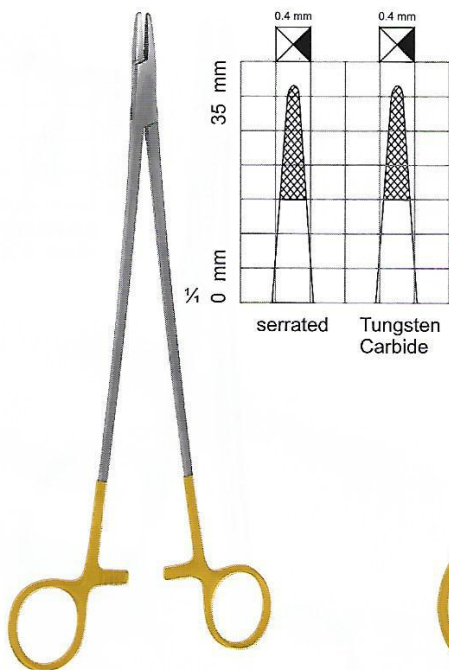

Wangensteen Needle Holders T.C
T.C F7-181
 27.3 cm, 10 3/4"

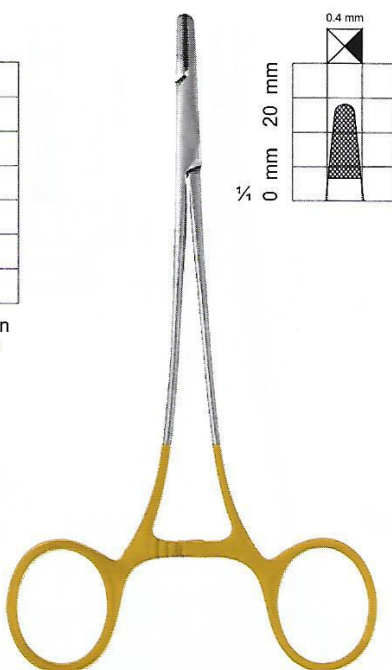

Finochietto Needle Holders T.C
T.C F7-182 13 cm, 5 1/4"
T.C F7-183 16 cm, 6 1/4"
T.C F7-184 19 cm, 7 1/2"
T.C F7-185 21 cm, 8 1/4"

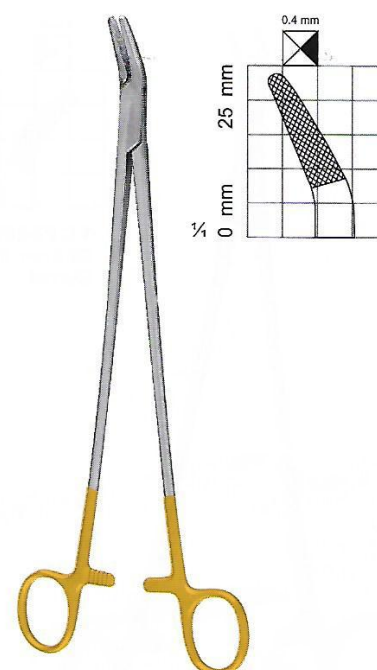

Finochietto Needle Holders T.C
T.C F7-186 13 cm, 5 1/4"
T.C F7-187 16 cm, 6 1/4"
T.C F7-188 19 cm, 7 1/2"

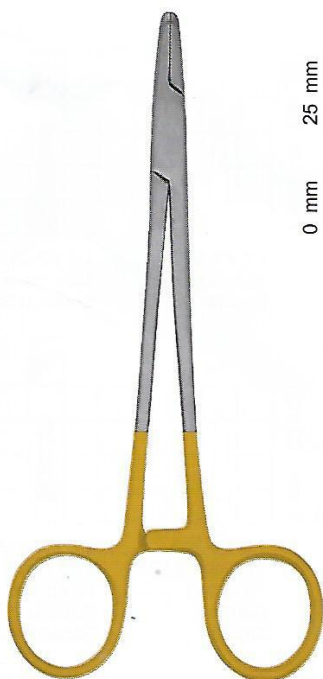

Mayo-Hegar Needle Holders T.C
 Also Available Right Handle

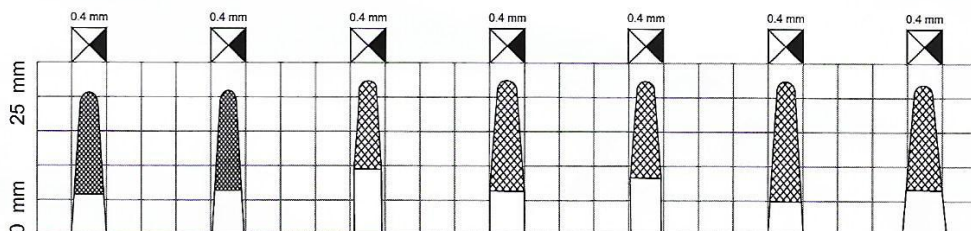

T.C F7-189 16 cm, 6 1/4"	T.C F7-191 20 cm, 8"	T.C F7-193 15.2 cm, 6"	T.C F7-195 17.8 cm, 7"	T.C F7-197 20.3 cm, 8"	T.C F7-199 23 cm, 9"	T.C F7-201 25 cm, 10"
T.C F7-190 17.8 cm, 7" Left handed.	T.C F7-192 20 cm, 8" Left handed.	T.C F7-194 15.2 cm, 6" Left handed.	T.C F7-196 17.8 cm, 7" Left handed.	T.C F7-198 20.3 cm, 8" Left handed.	T.C F7-200 23 cm, 9" Left handed.	T.C F7-202 25 cm, 10" Left handed.

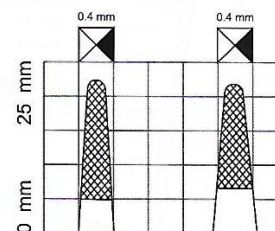

T.C F7-203 27.94 cm, 11"	T.C F7-205 29.8 cm, 12"
T.C F7-204 27.94 cm, 11" Left handed.	T.C F7-206 29.8 cm, 12" Left handed.



NEEDLE HOLDERS T.C

Nadelhalter | Porta-agujas
 Prote-aiguilles | Porta aghi

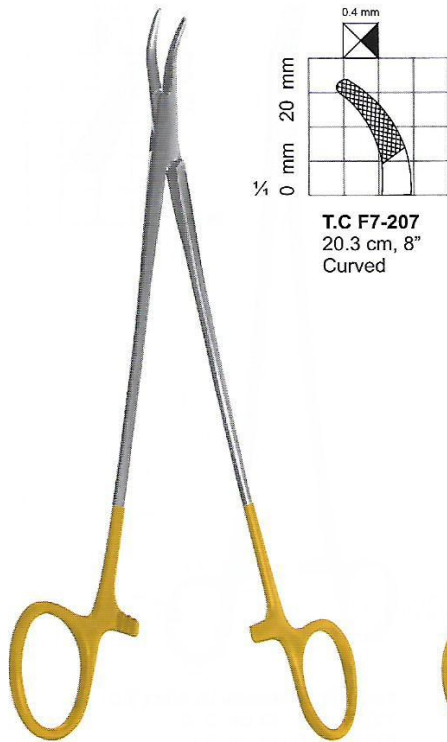

T.C F7-207
 20.3 cm, 8"
 Curved

Finochietto Needle Holders T.C



T.C F7-208
 17.8 cm, 7"

Rochester Needle Holders T.C



T.C F7-209
 16 cm, 6 1/4"

Gillies Needle Holders T.C

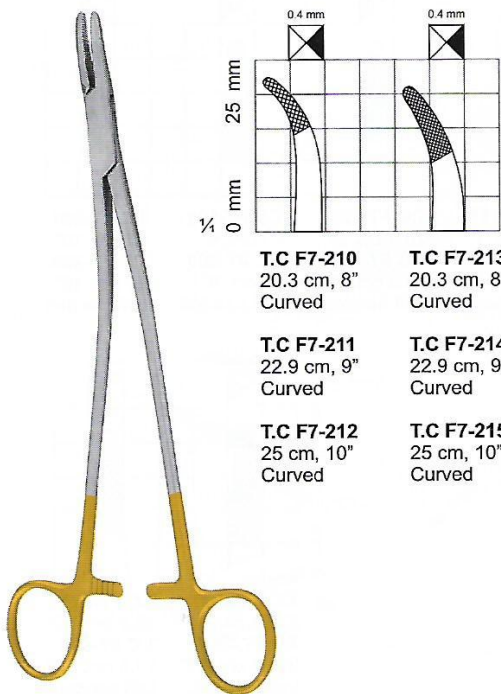

T.C F7-210
 20.3 cm, 8"
 Curved

T.C F7-213
 20.3 cm, 8"
 Curved

T.C F7-211
 22.9 cm, 9"
 Curved

T.C F7-214
 22.9 cm, 9"
 Curved

T.C F7-212
 25 cm, 10"
 Curved

T.C F7-215
 25 cm, 10"
 Curved

Stratte Needle Holders T.C



Halsey Needle Holders T.C

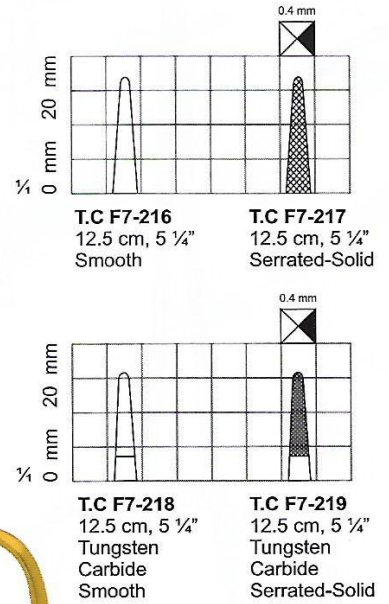

T.C F7-216
 12.5 cm, 5 1/4"
 Smooth

T.C F7-217
 12.5 cm, 5 1/4"
 Serrated-Solid

T.C F7-218
 12.5 cm, 5 1/4"
 Tungsten Carbide
 Smooth

T.C F7-219
 12.5 cm, 5 1/4"
 Tungsten Carbide
 Serrated-Solid

NEEDLE HOLDERS T.C



Nadelhalter | Porta-agujas
 Prote-aiguilles | Porta aghi



Ryder Needle Holders T.C
 Narrow jaws.

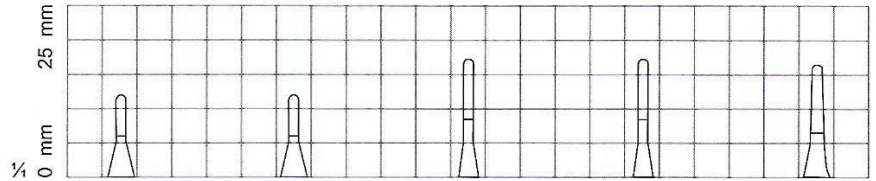

T.C F7-220 Smooth inserts. 12.7 cm, 5 1/2"	T.C F7-221 Smooth inserts. 15.2 cm, 6"	T.C F7-222 Smooth inserts. 17.8 cm, 7"	T.C F7-223 Smooth inserts. 20.3 cm, 8"	T.C F7-224 Smooth inserts. 22.9 cm, 9"
---------------------------------------------------------	-----------------------------------------------------	-----------------------------------------------------	-----------------------------------------------------	-----------------------------------------------------

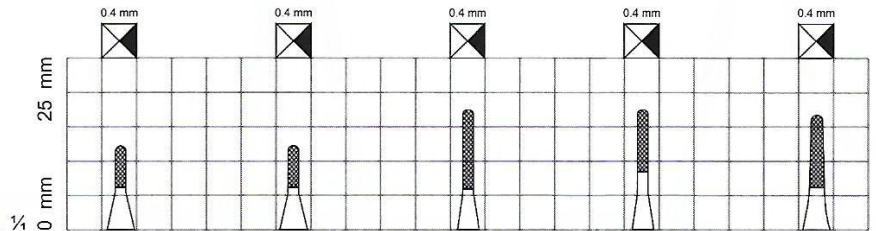

T.C F7-225 12.7 cm, 5 1/4"	T.C F7-226 15.2 cm, 6"	T.C F7-227 17.8 cm, 7"	T.C F7-228 20.3 cm, 8"	T.C F7-229 22.9 cm, 9"
--------------------------------------	----------------------------------	----------------------------------	----------------------------------	----------------------------------

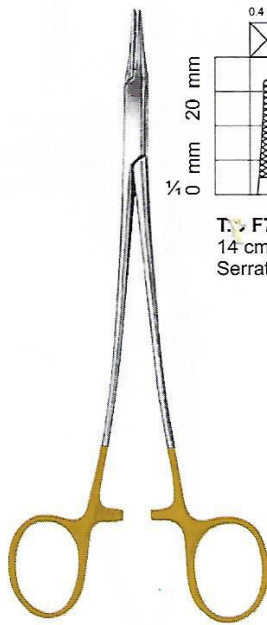

**Eufate Pasque T.C
 Needle Holders**

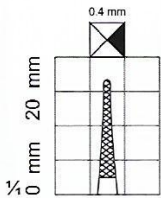

T.C F7-230
 14 cm, 5 1/2"
 Serrated-Delicate

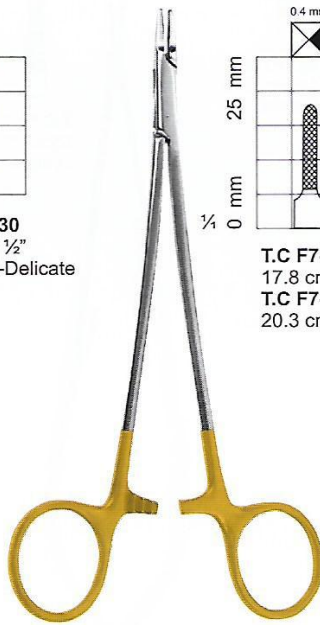

**Cooley Intracardiac Needle
 Holders T.C**
 Narrow Jaw.

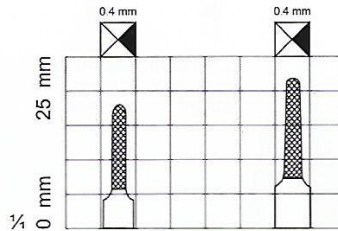

T.C F7-231 17.8 cm, 7"	T.C F7-233 22.9 cm, 9"
T.C F7-232 20.3 cm, 8"	T.C F7-234 26.3 cm, 10 1/2"

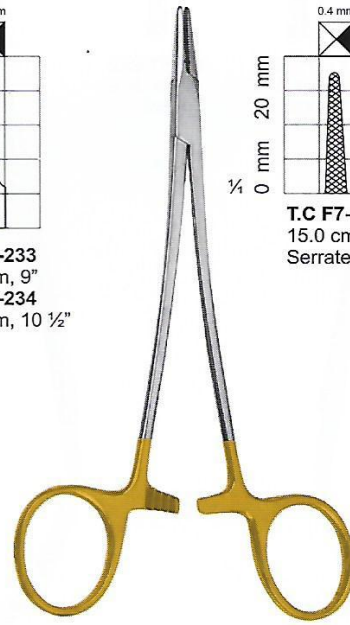

**Baby Crile-Wood Needle
 Holders T.C**

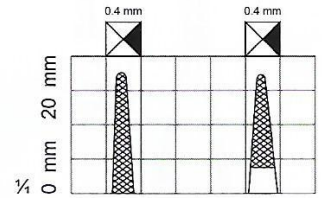

T.C F7-235 15.0 cm, 6"	T.C F7-236 15 cm, 6"
Serrated-Solid	Serrated-Solid



NEEDLE HOLDERS T.C

Nadelhalter | Porta-agujas
Prote-aiguilles | Porta aghi



Derf Needle Holders T.C

Baumgartner Needle Holders T.C

Halsey Needle Holders T.C

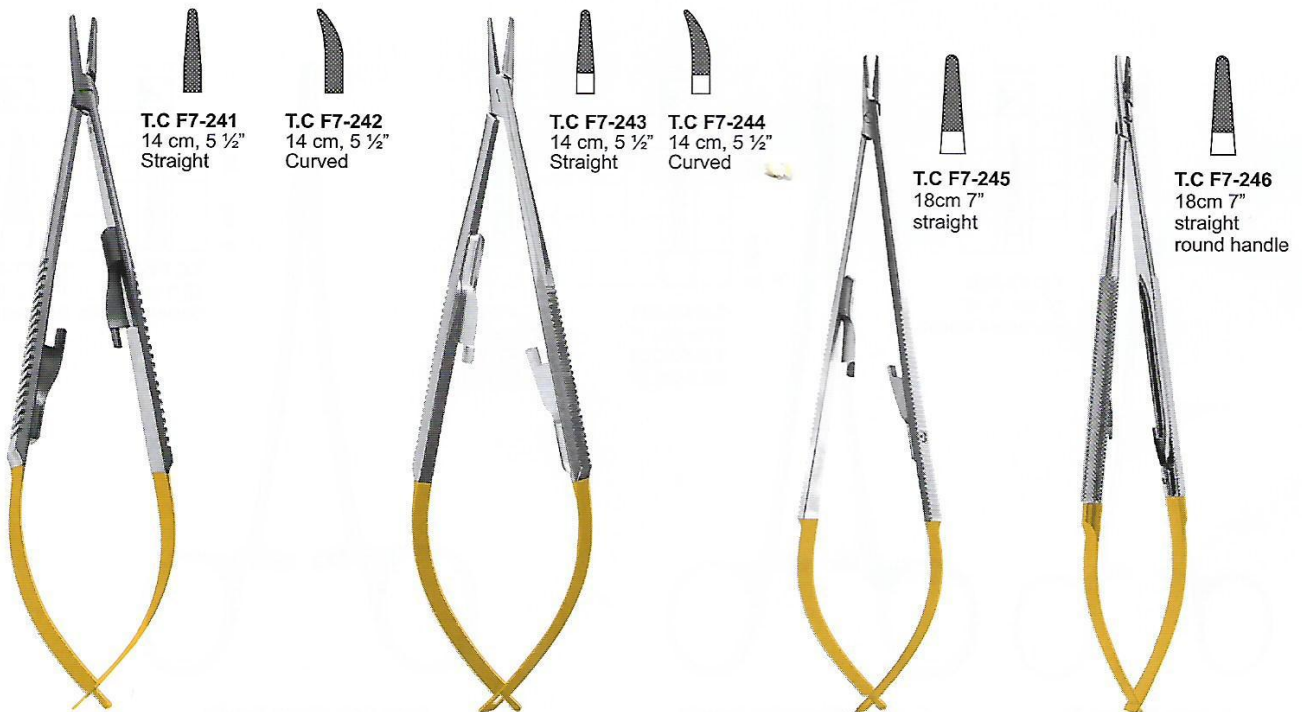

Castroviejo Needle Holders T.C

Castroviejo Needle Holders T.C

Castroviejo Needle Holders T.C

Castroviejo Needle Holders T.C

NEEDLE HOLDERS T.C



Nadelhalter | Porta-agujas
 Prote-aiguilles | Porta aghi

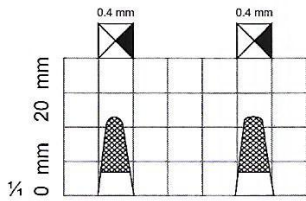
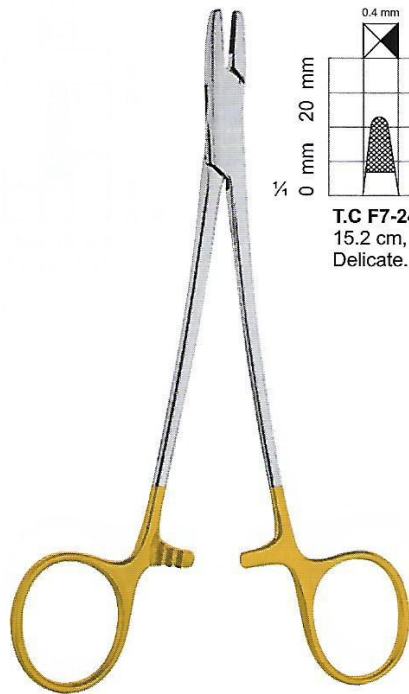

T.C F7-247
 15.2 cm, 6"
 Delicate.

T.C F7-248
 15.2 cm, 6"
T.C F7-249
 17.8 cm, 7"
T.C F7-250
 20 cm, 8"
 Heavy

Wire Twisters Needle Holders T.C

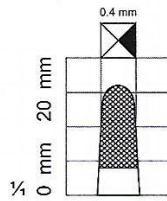

T.C F7-251
 17.8 cm, 7"
 Wire Twister

Sternum Needle Holders T.C

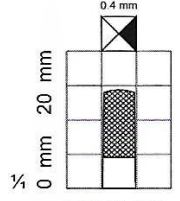
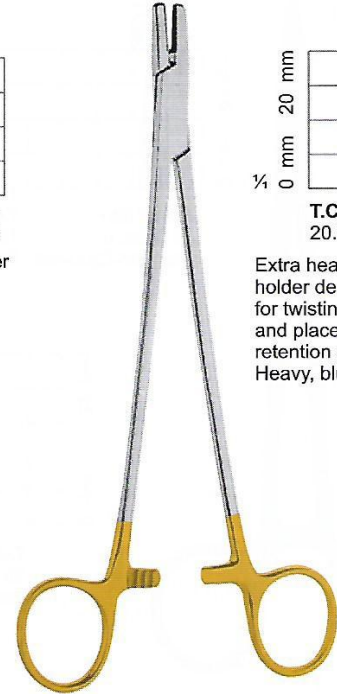

T.C F7-252
 20.3 cm, 8"

Extra heavy needle holder designed for twisting of wire and placement of retention suture. Heavy, blunt jaws.

Cooley-Baumgaften Wire Twister Needle Holders T.C

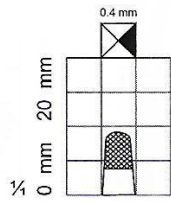
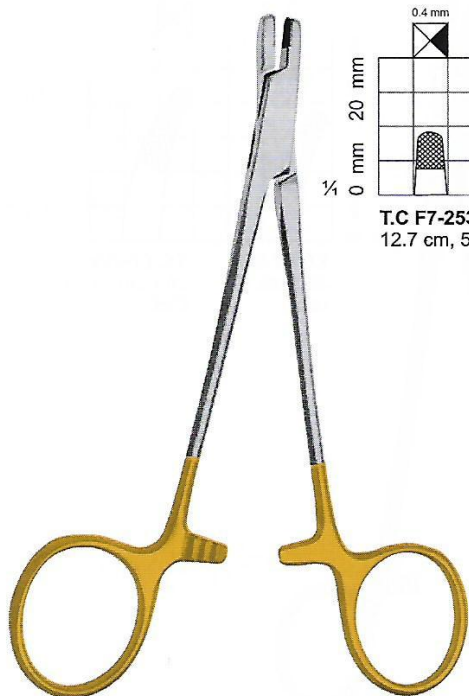

T.C F7-253
 12.7 cm, 5 1/4"

Rubio Wire Twister Needle Holders T.C



Wire Tightening Needle Holders T.C
T.C F7-254 18 cm, 7"

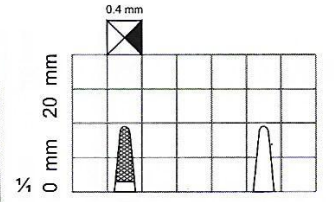
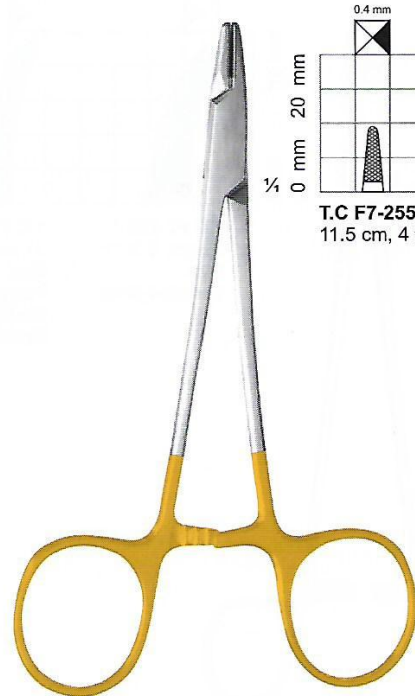

T.C F7-255
 11.5 cm, 4 3/4"

T.C F7-256
 11.5 cm, 4 3/4"
 Smooth

Micro Derf Needle Holders T.C



NEEDLE HOLDERS T.C

Nadelhalter | Porta-agujas
 Prote-aiguilles | Porta aghi

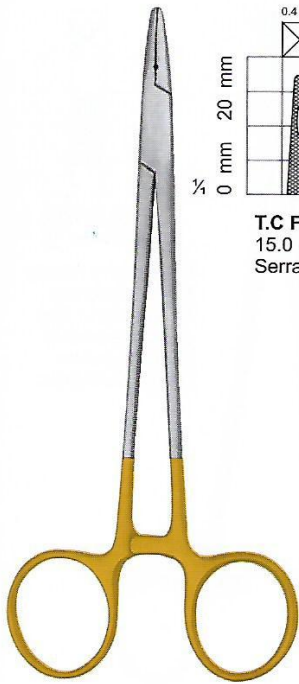

Crile-Wood Needle Holders T.C

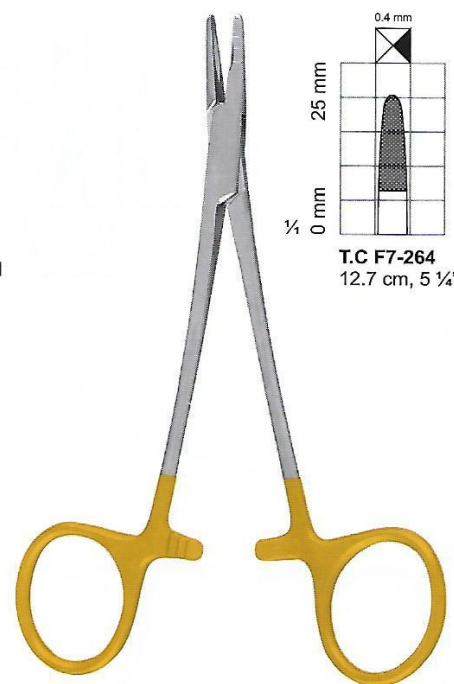
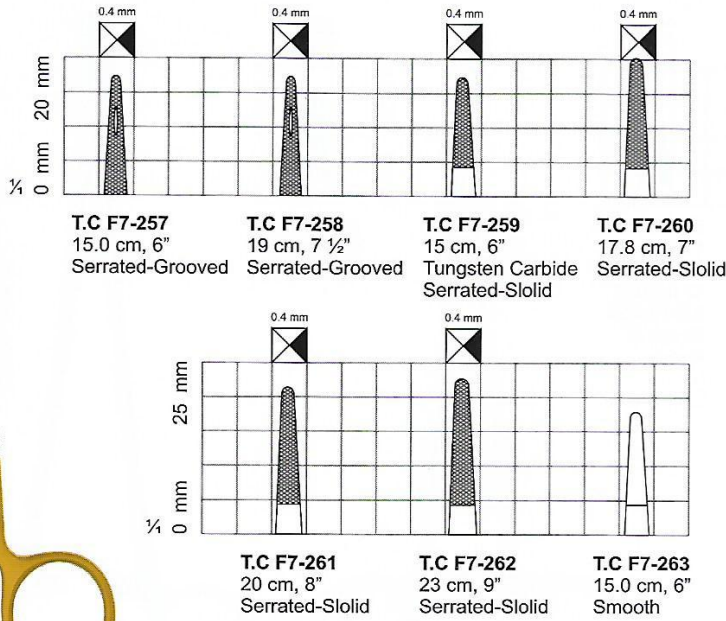

Neivert Needle Holders T.C

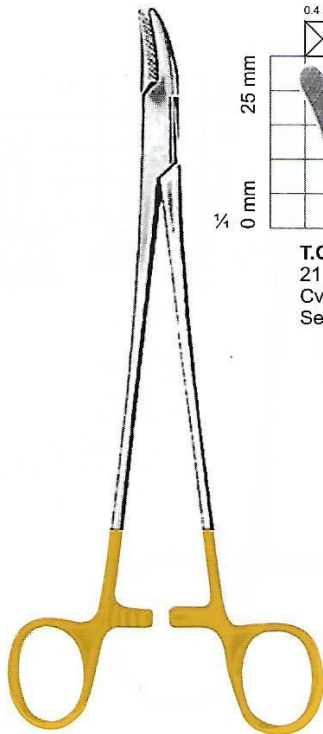
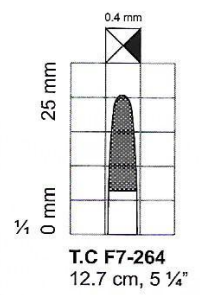

Heaney-Gyne Needle Holders T.C

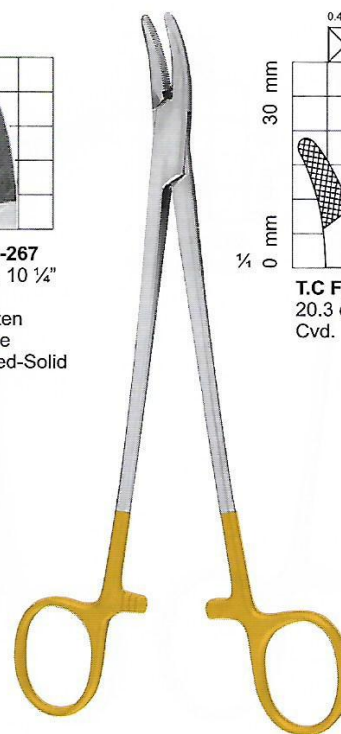
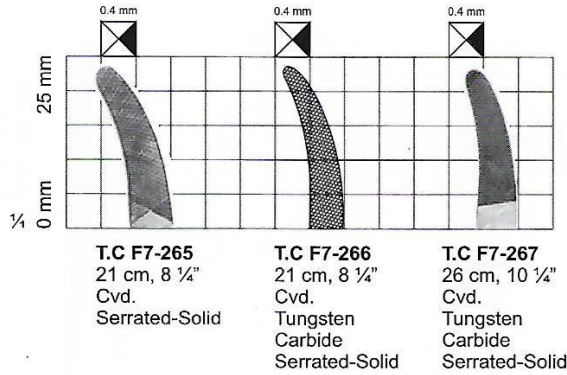

Heaney Needle Holders T.C

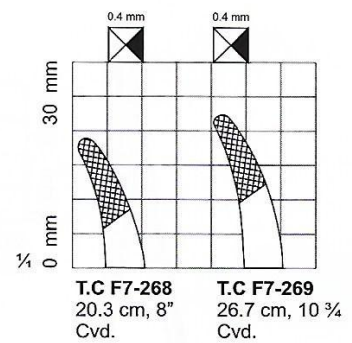

NEEDLE HOLDERS T.C

Nadelhalter | Porta-agujas
 Prote-aiguilles | Porta aghi



Webster Needle Holders T.C

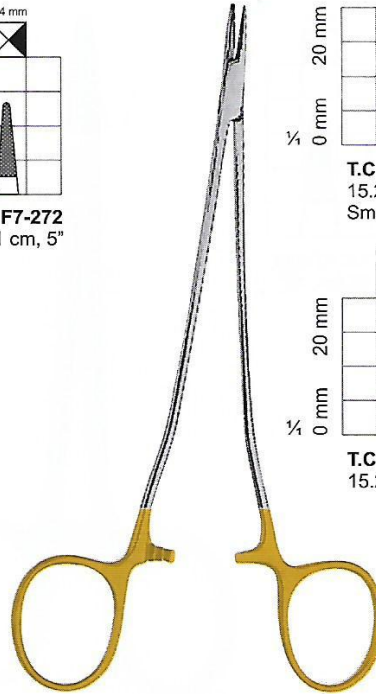
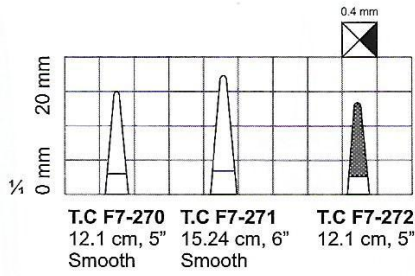

Cooley Microvascular Needle Holders T.C

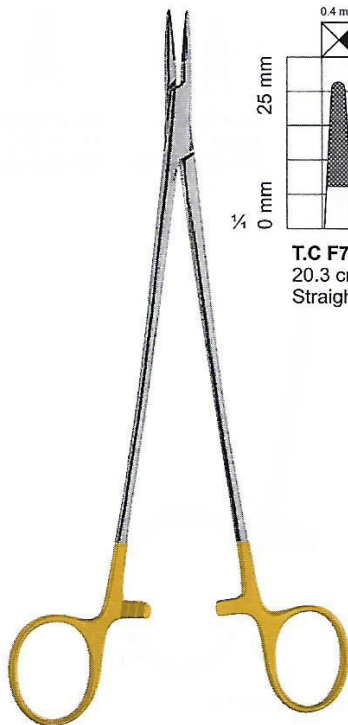
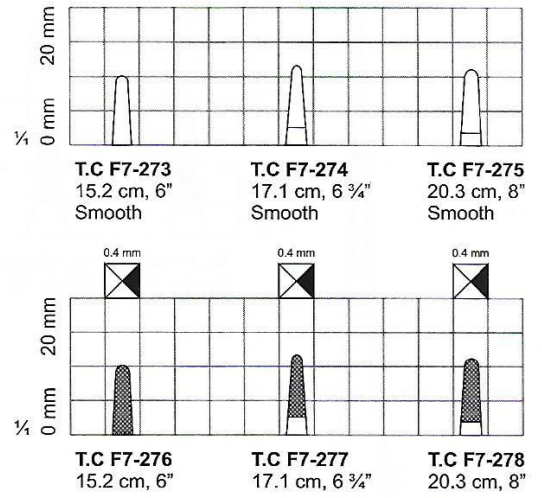

Julian Needle Holders T.C

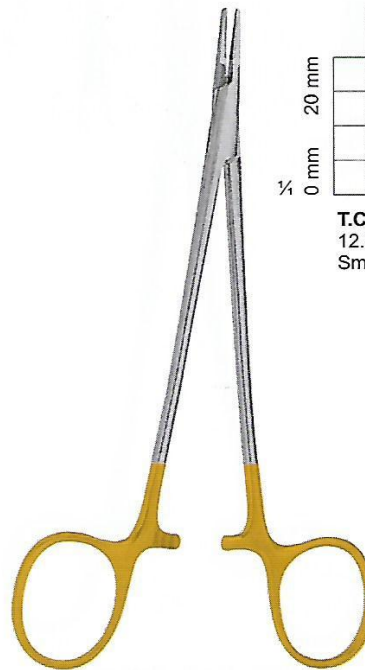
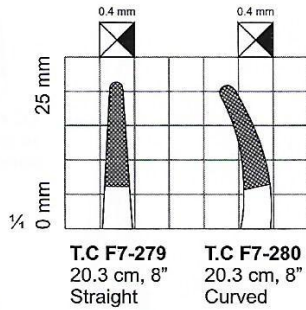

Micro Surgical Needle Holders T.C

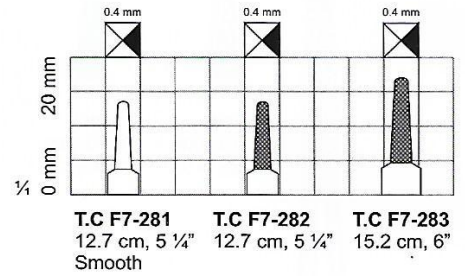



NEEDLE HOLDERS T.C

Nadelhalter | Porta-agujas
Prote-aiguilles | Porta aghi

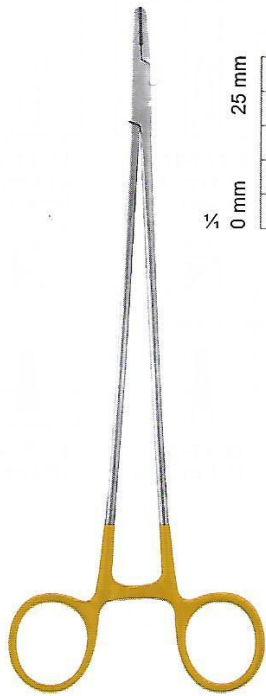

Masson Needle Holders T.C

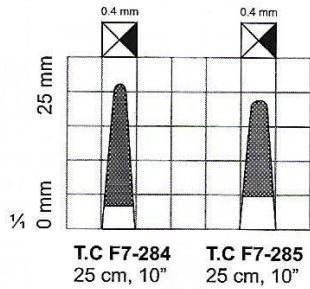

Webster Needle Holders T.C

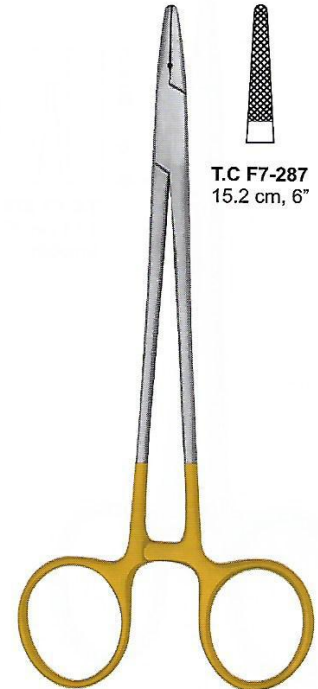
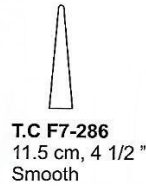

Crile-Wood Needle Holders T.C.

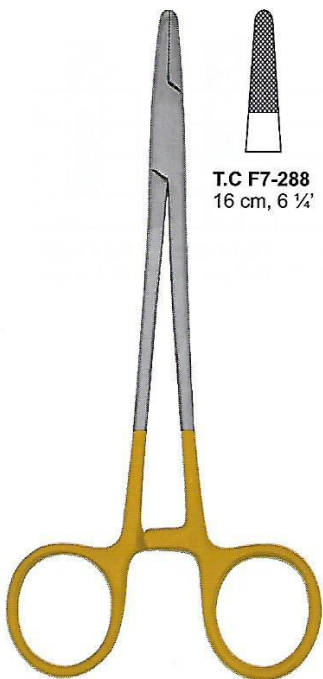
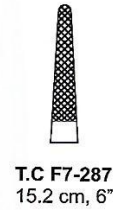

Mayo-Hegar Needle Holders T.C
Also Available Right Handle

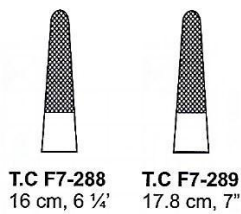

De Bakey Needle Holders T.C
T.C F7-290
17.8 cm, 7"
Delicate



Olsen-Hegar Needle Holders T.C

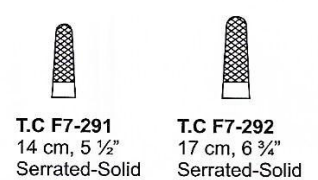

NEEDLE HOLDERS T.C



Nadelhalter | Porta-agujas
 Prote-aiguilles | Porta aghi

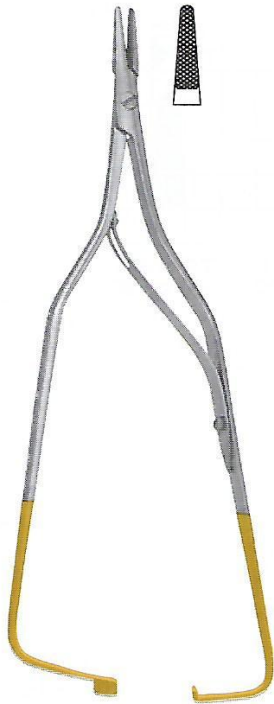

Arruga Needle Holders T.C
 T.C F7-293 16 cm, 6 1/4" Str.
 T.C F7-294 16 cm, 6 1/4" Cvd.

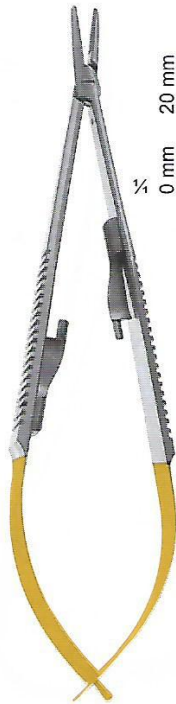

Castroviejo Needle Holders T.C

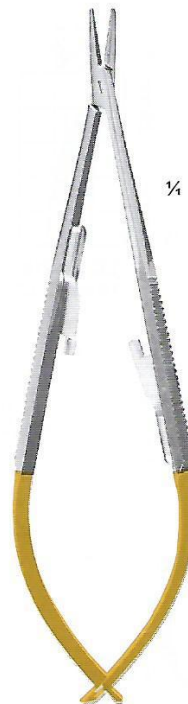
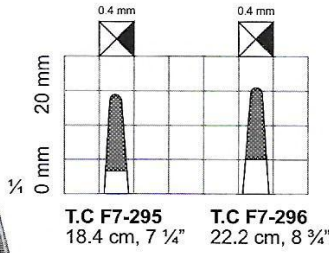

Castroviejo Needle Holders T.C

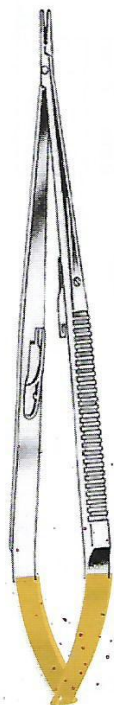
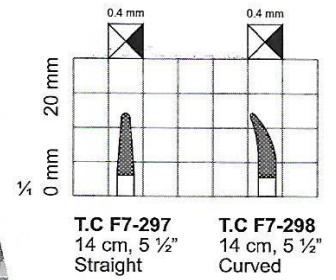

Jacobson Needle Holders T.C

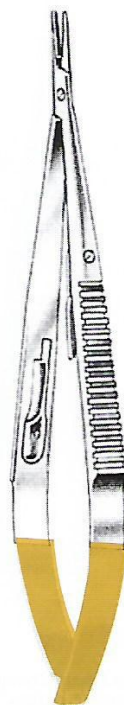
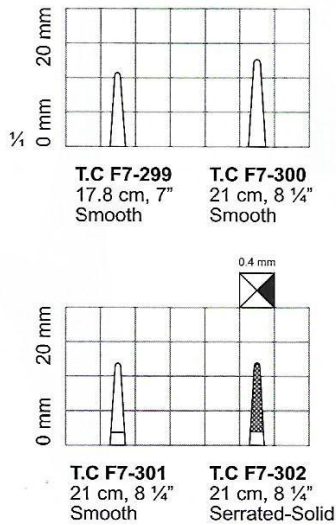

Castroviejo Needle Holders T.C

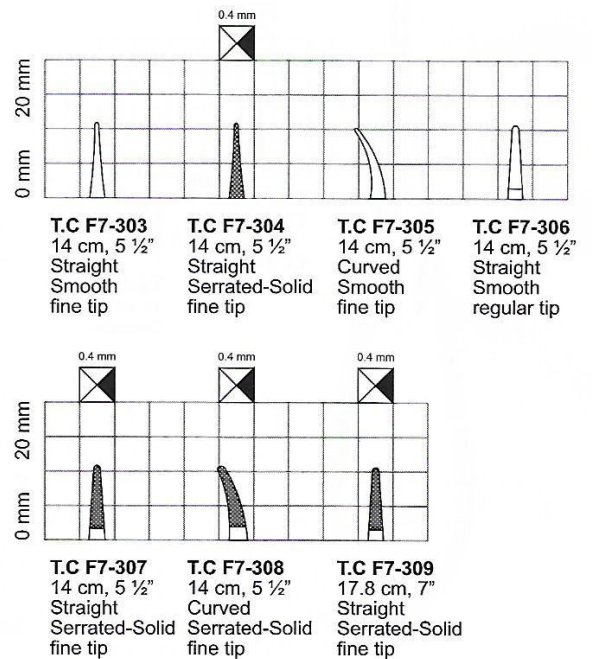



NEEDLE HOLDERS T.C

Nadelhalter | Porta-agujas
Prote-aiguilles | Porta aghi

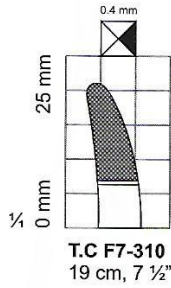

Metzenbaum Needle Holders T.C

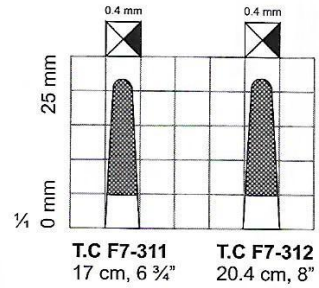

Mathieu-Stille Needle Holders T.C

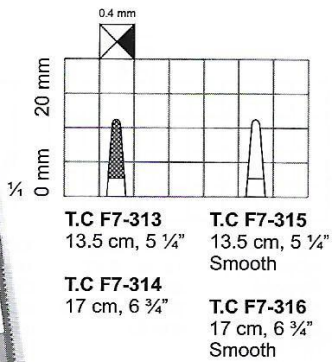

Castroviejo Needle Holders T.C

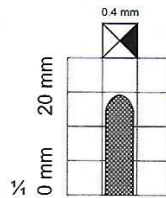

Jacobson Heavy Style Needle Holders T.C
T.C F7-317 19.0 cm, 7 ½"
T.C F7-318 22.9 cm, 9"
T.C F7-319 25.4 cm, 10"

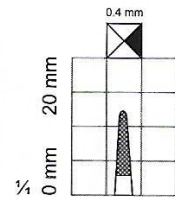

Kalt Needle Holders T.C
T.C F7-320
 14 cm, 5 ½" Str.

NEEDLE HOLDERS T.C



Nadelhalter | Porta-agujas
 Prote-aiguilles | Porta aghi

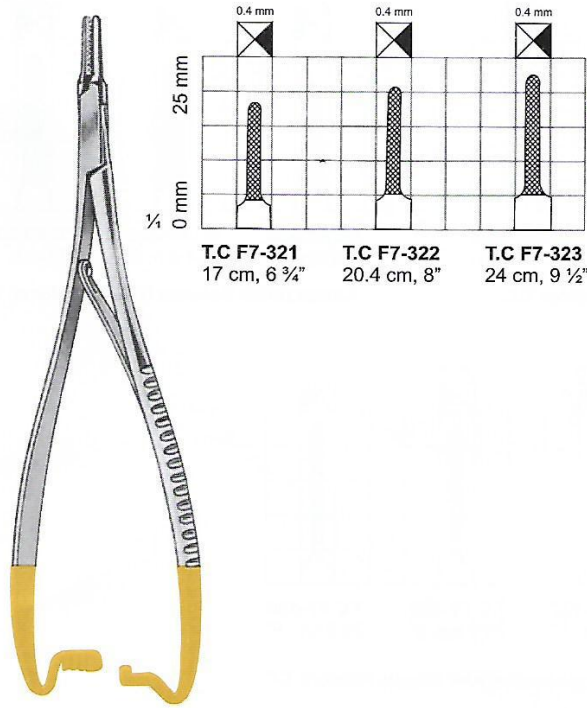

Mathieu-Ryder Needle Holders T.C

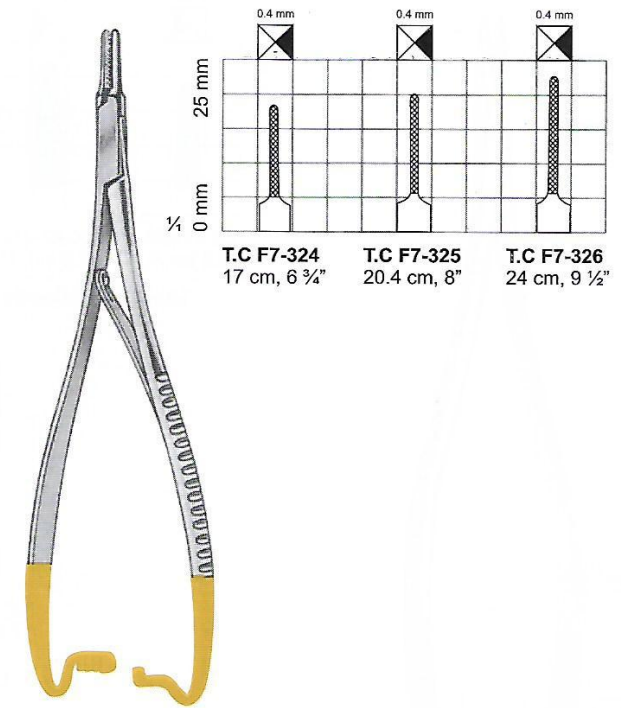

Mathieu-Ryder Vascular Needle Holders T.C

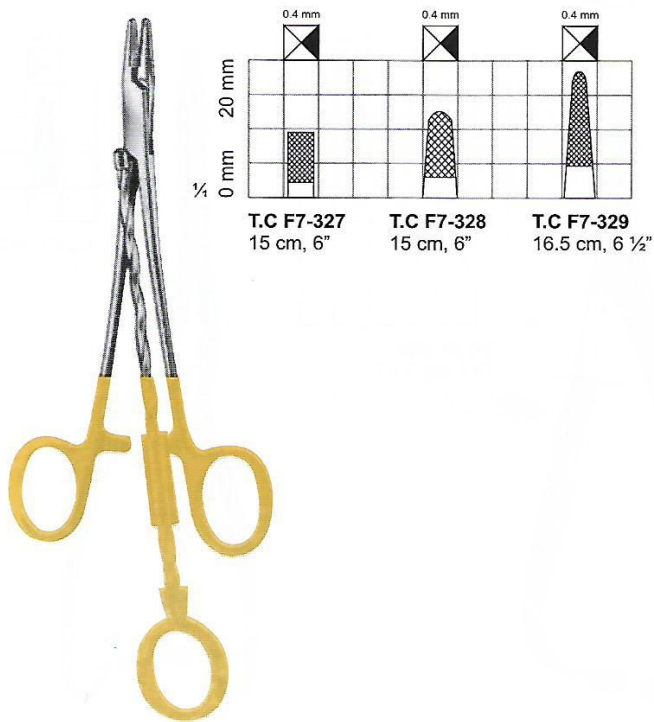

Corwin Needle Holders T.C

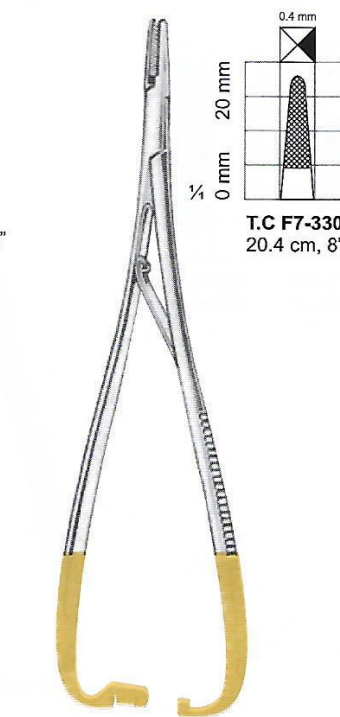

Lichtenberg Needle Holders T.C



NEEDLE HOLDERS T.C

Nadelhalter | Porta-agujas
 Prote-aiguilles | Porta aghi

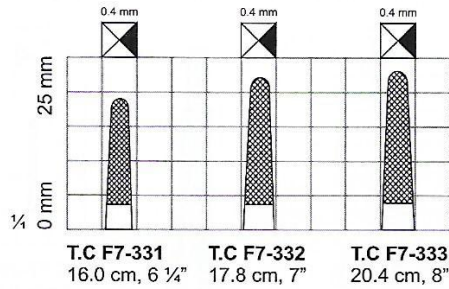
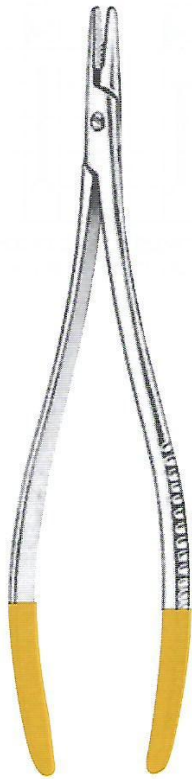

Langenbeck Needle Holders T.C

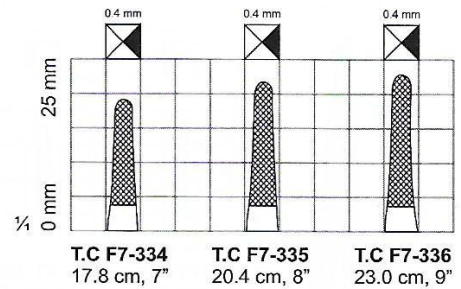

Langenbeck-Delicate Needle Holders T.C

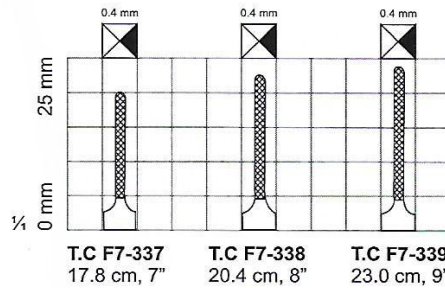

Langenbeck-Ryder Needle Holders T.C

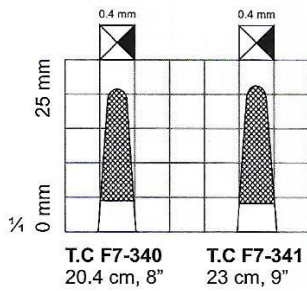
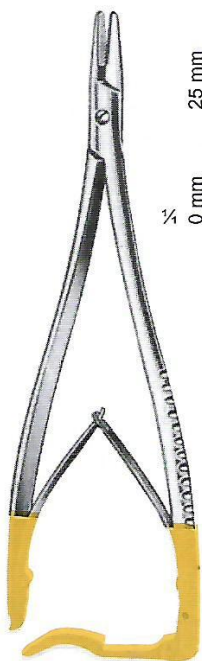

Zweifel Needle Holders T.C

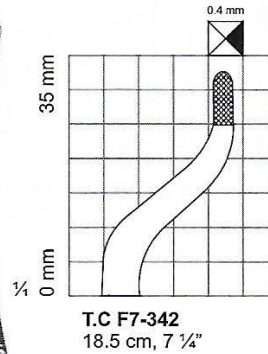
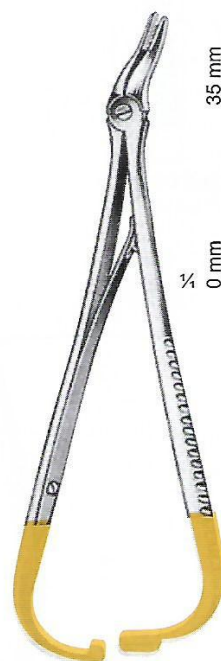

Eiselsberg-Matheiu
 Needle Holders T.C

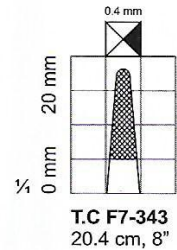
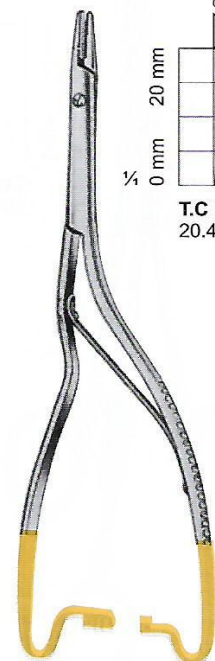

Luethy-Beck
 Needle Holders T.C

TITANIUM NEEDLE HOLDERS



Nadelhalter | Porta-agujas
 Prote-aiguilles | Porta aghi



T F7-344
 TC-Coated jaws
 Straight
 11.5cm 4.5"

Derf Needle Holder
 Ring Handle



T F7-345
 TC-Coated jaws
 Straight
 11.5cm 4.5"

Webster Needle Holder
 Ring Handle



T F7-346
 TC-Coated jaws
 Straight
 13cm 5"

Halsey Needle Holders
 Ring Handle



T F7-347 15cm 6"
T F7-348 17cm 6.75"
T F7-349 19cm 7.5"
 Micro Jaws,
 TC-Coated jaws
 Straight

**Richards Micro
 Needle Holders**
 Ring Handle



T F7-350 15cm 6"
T F7-351 17cm 6.75"
T F7-352 19cm 7.5"
 TC-Coated jaws
 Straight

Ryder Needle Holders
 Ring Handle

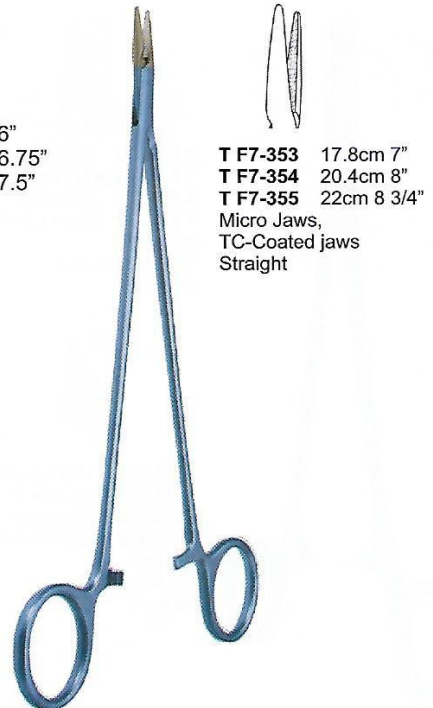

T F7-353 17.8cm 7"
T F7-354 20.4cm 8"
T F7-355 22cm 8 3/4"
 Micro Jaws,
 TC-Coated jaws
 Straight

Ultra-Micro Needle Holders
 Ring Handle



TITANIUM NEEDLE HOLDERS

Nadelhalter | Porta-agujas
Prote-aiguilles | Porta aghi

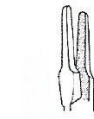

- T F7-356 17.8cm 7"
- T F7-357 20.4cm 8"
- T F7-358 22cm 8 3/4"
- T F7-359 25cm 10"
- TC-Coated jaws
- Straight

Intracardiac Needle Holder
Ring Handle



- T F7-360 16cm 6 1/4"
- T F7-361 17.8cm 7"
- T F7-362 20.4cm 8"
- T F7-363 22cm 8 3/4"
- T F7-364 25cm 10"
- TC-Coated jaws
- Straight

DeBakey Needle Holders
Ring Handle



- T F7-365 17.8cm 7"
- T F7-366 20.4cm 8"
- T F7-367 22cm 8 3/4"
- T F7-368 25cm 10"
- Micro, jaws
- TC-Coated jaws
- w/Lock
- Straight

Microvascular Needle Holders
Ring Handle



- T F7-369 16cm 6 1/4"
- T F7-370 17.8cm 7"
- T F7-371 20.4cm 8"
- T F7-372 22cm 8 3/4"
- 2.8mm
- TC-Coated jaws
- Straight

Mayo-Hegar Needle Holders
Ring Handle



- T F7-373 16cm 6 1/4"
- T F7-374 17.8cm 7"
- T F7-375 20.4cm 8"
- T F7-376 22cm 8 3/4"
- 2.8mm
- TC-Inserted jaws
- Straight

Jacobson Heavy Needle Holders
Round Handle, Straight / Curved Jaws



- Heavy, TC-Coated jaws w/Lock
- T F7-377 18.5cm 7.25"
- T F7-378 21cm 8.25"
- T F7-379 23cm 9.25"
- T F7-380 25cm 10"
- T F7-381 30cm 12"

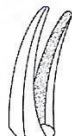

- Heavy, TC-Coated jaws w/Lock
- T F7-382 18.5cm 7.25"
- T F7-383 21cm 8.25"
- T F7-384 23cm 9.25"
- T F7-385 25cm 10"



- Straight, Micro, TC-Coated
- T F7-386 jaws
- T F7-387 jaws w/Lock



- Curved, Micro, TC-Coated
- T F7-388 jaws
- T F7-389 jaws w/Lock

Micro Needle Holders
W/Round Bayonet Handle 23.5cm 9.5"

- Round Bayonet Handle,
- Straight / Curved Up /
- Curved Down Jaws
- Round Bayonet Handle,
- Straight / Curved Up /
- Curved Down Jaws

REVERDIN NEEDLES



Reverdin nadeln | Aguilles de reverdin
 agujas de reverdin | aghi di reverdin



Reverdin Needle
short



F7-390
14.5cm, 5 3/4"



F7-391
14.5cm, 5 3/4"

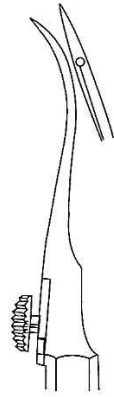

F7-392
14.5cm, 5 3/4"

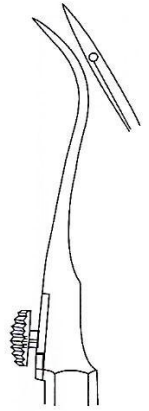

F7-393
14.5cm, 5 3/4"



Reverdin Needle
**F7-394-
F7-397**
Small



F7-394
19.5cm, 7 3/4"



F7-395
19.5cm, 7 3/4"

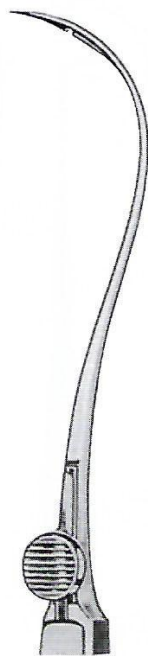

F7-396
19.5cm, 7 3/4"

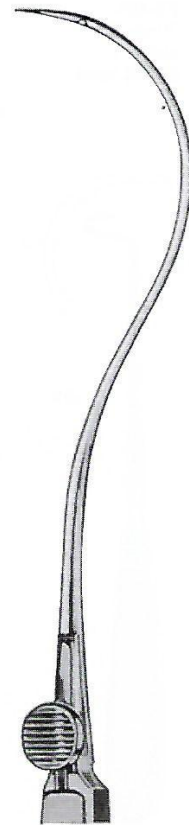

F7-397
19.5cm, 7 3/4"



Reverdin Needle
**F7-398-
F7-401**
long



LIGATUER NEEDLES

Unterbindungsnadeln
agujas para ligaduras

Aiguilles à ligatures
aghi di legatura

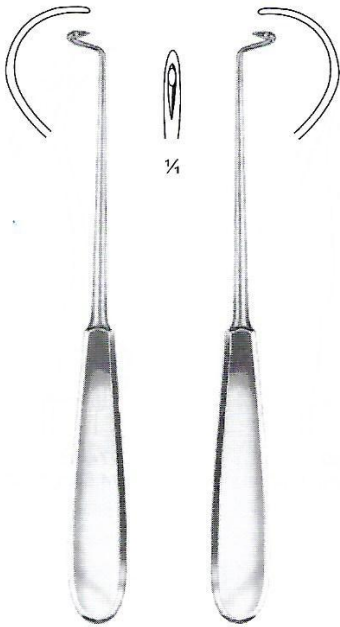

Deschamps Needle
F7-402 20cm, 8"
sharp
for right hand

Deschamps Needle
F7-403 20cm, 8"
sharp
for left hand

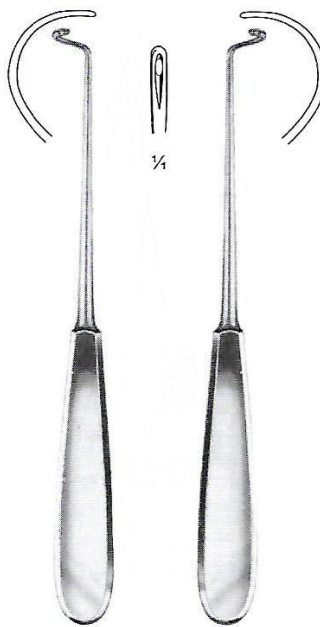

Deschamps Needle
F7-404 20cm, 8"
blunt
for right hand

Deschamps Needle
F7-405 20cm, 8"
blunt
for left hand

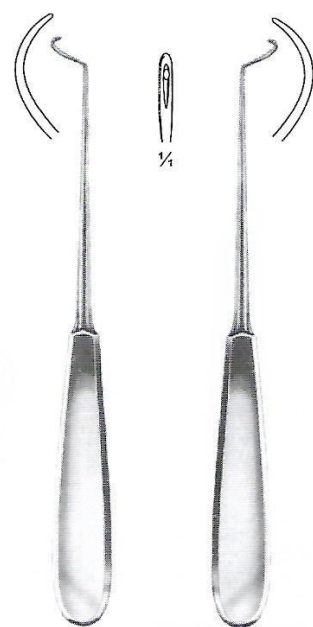

Deschamps Needle
F7-406 21cm, 8 1/4"
blunt
for right hand

Deschamps Needle
F7-407 21cm, 8 1/4"
blunt
for left hand

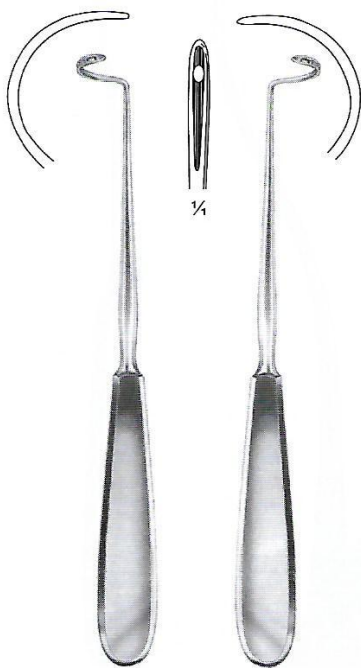

Deschamps Needle
F7-408 20cm
blunt
for right hand

Deschamps Needle
F7-409 20cm
blunt
for left hand

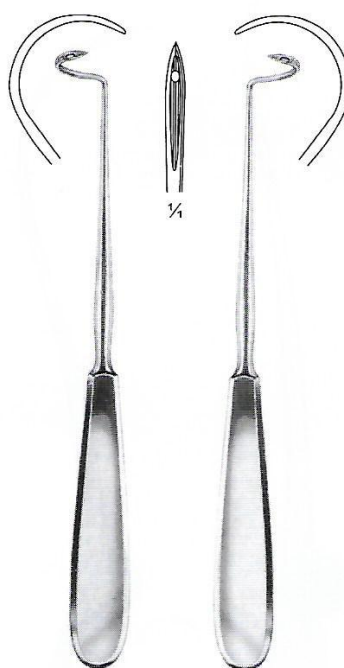

Deschamps Needle
F7-410 20cm
sharp
for right hand

Deschamps Needle
F7-411 20cm
sharp
for left hand

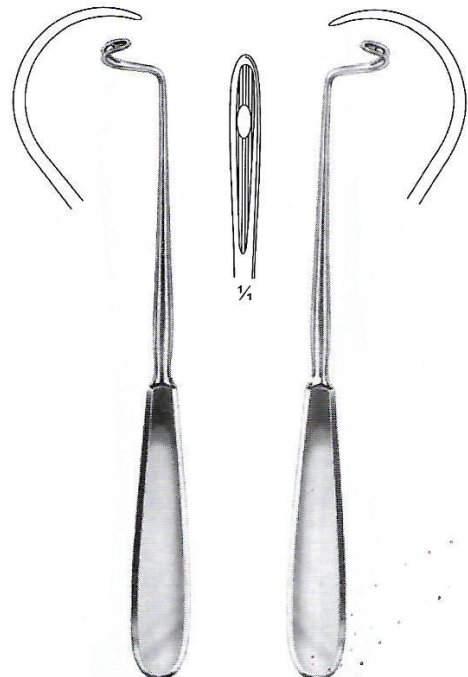

Deschamps Needle
F7-412 20cm
blunt
for right hand

Deschamps Needle
F7-413 20cm
blunt
for left hand

LIGATUER NEEDLES



Unterbindungsnadeln
aguja para ligaduras

Aiguilles à ligatures
aghi di legatura



Deschamps Needle

F7-414	F7-415
20cm, 8"	20cm, 8"
sharp	sharp
for right	for left
hand	hand

Deschamps Needle

F7-416	F7-417
27cm, 10 3/4"	27cm, 10 3/4"
blunt	blunt
for right	for left
hand	hand

Deschamps Needle

F7-418	F7-419
27cm, 10 3/4"	27cm, 10 3/4"
sharp	sharp
for right	for left
hand	hand

Deschamps Needle

F7-420	F7-421
28cm, 11"	28cm, 11"
blunt	blunt
for right	for left
hand	hand

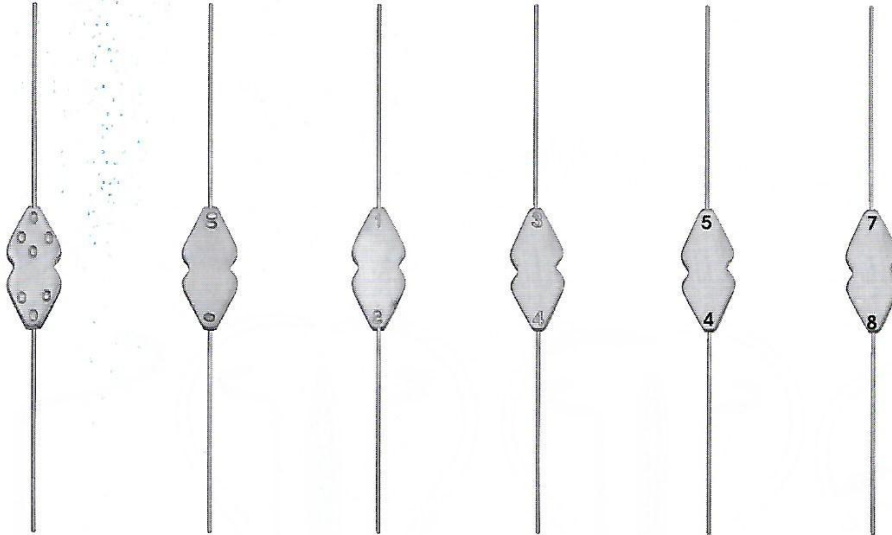

BOWMAN LACRIMAL PROBES
Double Ended, Sterling Silver

F7-422
Bowman Probe,
000-0000

F7-423
Bowman Probe,
00-0

F7-424
Bowman Probe,
1-2

F7-425
Bowman Probe,
3-4

F7-426
Bowman Probe,
5-6

F7-427
Bowman Probe,
7-8

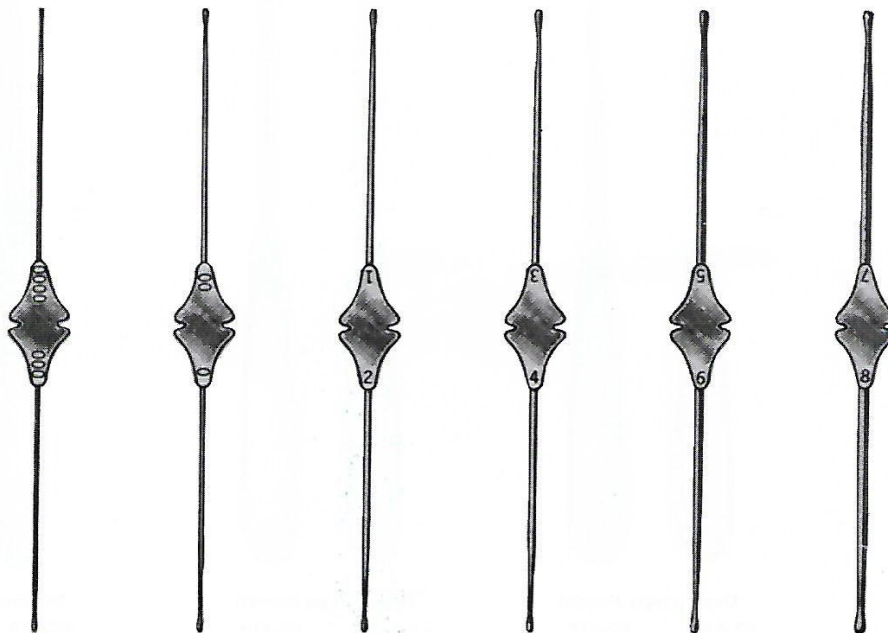

WILLIAM LACRIMAL PROBES
Double Ended, Sterling Silver

F7-428
William Probe,
000-0000

F7-429
William Probe,
00-0

F7-430
William Probe,
1-2

F7-431
William Probe,
3-4

F7-432
William Probe,
5-6

F7-433
William Probe,
7-8

PROBE & DIRECTORS



Allgemeines Instrumentarium
Instrumental general

Instrumentation générale
Strumentario generale

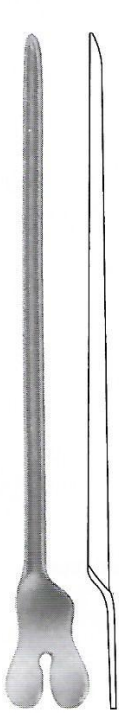

DIRECTORS
F7-434 13 cm, 5"
F7-435 14.5 cm, 5 3/4"
F7-436 16 cm, 6"
LARRY Probe and
Grooved Director, 7" 17.8 cm

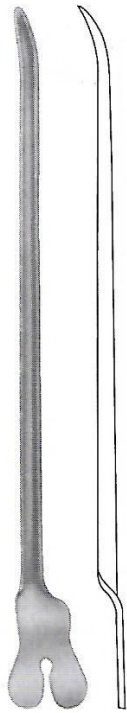

DOYEN
F7-437
14.5 cm, 5 3/4"

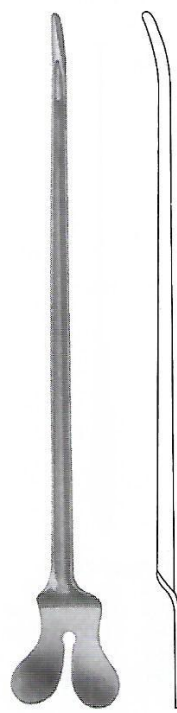

NELATON
F7-438
16 cm, 6"

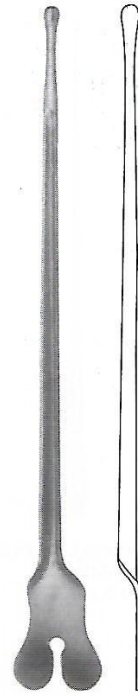

DIRECTOR
Probe End
F7-439
14 cm, 5 1/2"
Director with tip
Diam. Of tip 3.3 mm

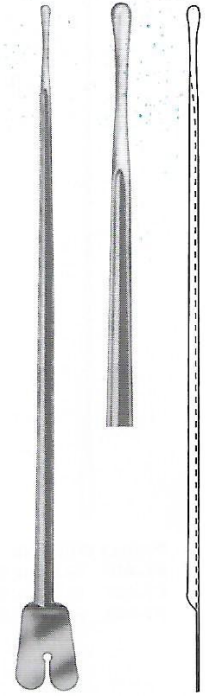

BRODIE
F7-440
20 cm, 8"
Director with tip
Diam. Of tip 3.5 mm

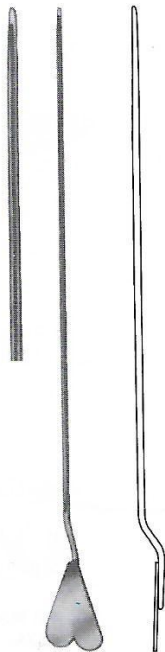

LOCKHART-MUMMERY
F7-441
16.5 cm, 6 1/2"

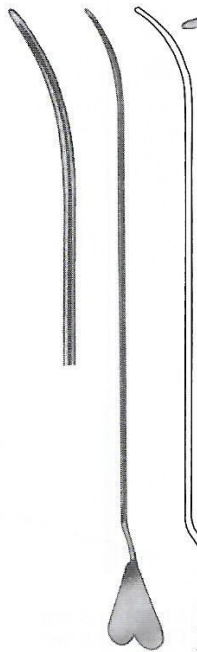

LOCKHART-MUMMERY
F7-442
16.5 cm, 6 1/2"

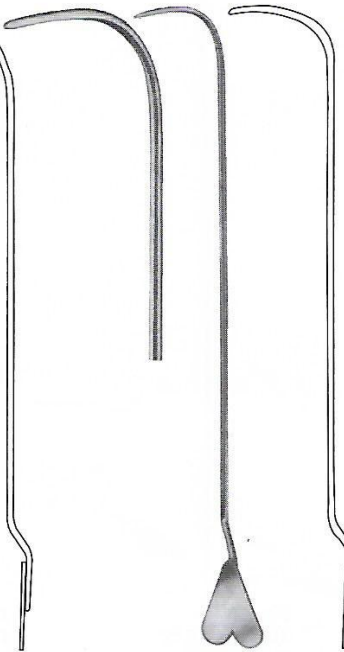

LOCKHART-MUMMERY
F7-443
16.5 cm, 6 1/2"

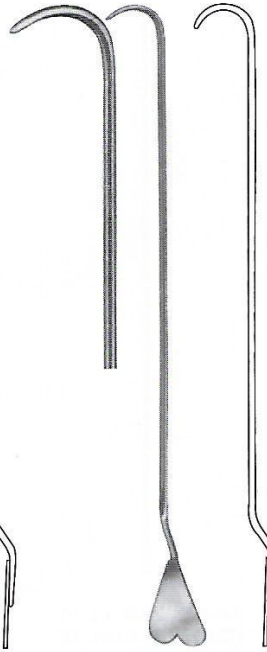

LOCKHART-MUMMERY
F7-444
16.5 cm, 6 1/2"



DIRECTOR
with wire
loop, malleable
F7-445
19 cm, 7 1/4"



PROBE & DIRECTORS

Allgemeines Instrumentarium
Instrumental general

Instrumentation générale
Strumentario generale



Probes With Eye
F7-446 14.5 cm, 5 ¾"
F7-447 16.0 cm, 6 ¼"
F7-448 20.0 cm, 8"



Myrtle Leaf Probe
F7-449 14.5 cm, 5 ¾"



Myrtle Leaf Probe
F7-450 13.0 cm, 5"
F7-451 14.5 cm, 5 ¾"
F7-452 16.0 cm, 6 ¼"
F7-453 18.5 cm, 7"
F7-454 20.0 cm, 8"



Probe
F7-455



WILDER Lacrimal Dilator,
F7-456
10.2 cm 4"
medium taper



F7-457
19.0 cm, 8 ¼"
Double ended probe,
malleable, diam, of tips
3 mm with hole



F7-458 25.0 cm, 10"
F7-459 30.0 cm, 12"
Double ended probes,
tin, malleable, diam, of tips
3.5 mm with hole



F7-460
40.0 cm, 15 ¾"
Double ended probes,
tin, malleable, diam, of tips
4 mm with hole



F7-461 1.5 mm
F7-462 2.0 mm
F7-463 2.5 mm
30.0 cm, 12"

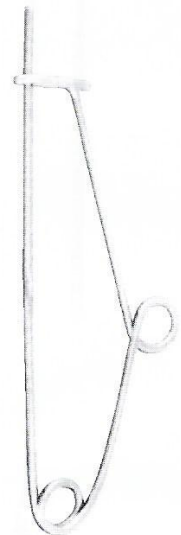

CLIPS MAYO
F7-463A 14cm

PROBE & SPATULA



Allgemeines Instrumentarium
Instrumental general

Instrumentation générale
Strumentario generale



STACKE
F7-464
10.0 cm, 4"



KILLIAN
F7-465
16.5 cm, 6 1/2"



F7-466
16.5 cm, 6 1/2"



SEIFFERT
F7-467
18.0 cm, 7"



SPATULA
F7-468
14.5 cm, 5 3/4"

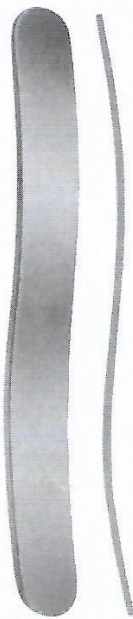

SPATULA
F7-469
14.5 cm, 5 3/4"



MODELL PICCOLO
F7-470
11.0 cm, 4 1/4"
Round Serrated



MODELL PICCOLO
F7-471 11.0 cm, 4 1/4"
Triangular Serrated end



FARRELL
F7-472
11.0 cm, 4 1/4"
Round Serrated end



LATHBURY-FARREL
F7-473
11.0 cm, 4 1/4"
Triangular Serrated end



RETRACTORS

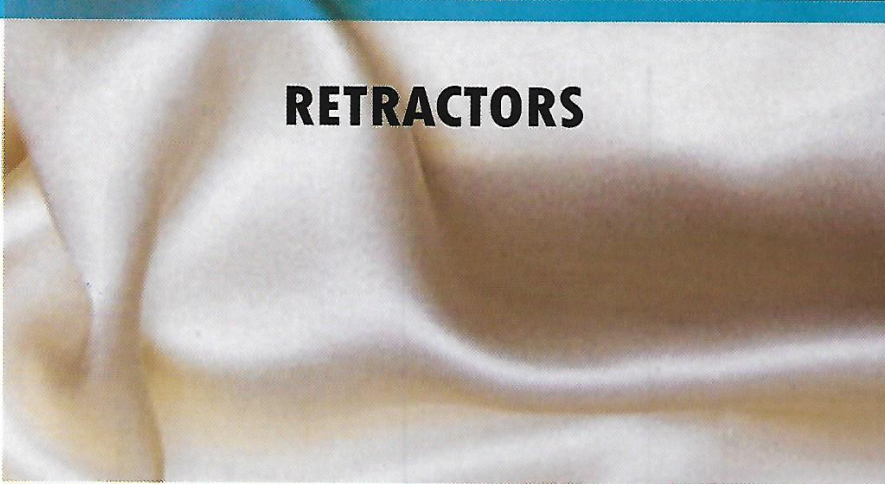

HOOKLET & SKIN HOOKS



Wundhäkchen, Mikrohäkchen
Ganchito, Micro Ganchitos

Crochet, Micro crochetes
Divaricatore, Micro Divaricatori



F8-001
16 cm, 6 1/4"
large curve

F8-002
16 cm, 6 1/4"
small curve

**GUTHRIE
HOOKLET**

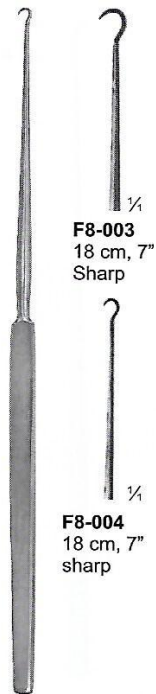

F8-003
18 cm, 7"
Sharp

F8-004
18 cm, 7"
sharp

**GILLIES
SKIN HOOK**



F8-005
15 cm, 6"
sharp

KILNER HOOK

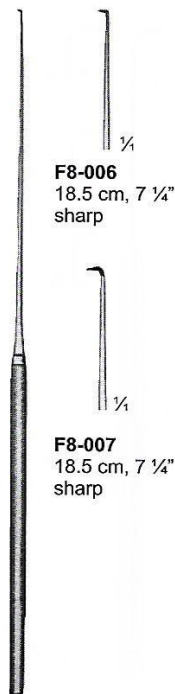

F8-006
18.5 cm, 7 1/4"
sharp

F8-007
18.5 cm, 7 1/4"
sharp

**FISCH HOOKLET
& Skin Hook**



F8-008
13 cm, 5"
F8-009
18 cm, 7"
Blunt

F8-010
13 cm, 5"
F8-011
18 cm, 7"
Sharp

**FRAZIER HOOKLET
& Skin Hook**



**DOUBLE PRONG MICRO
HOOK & Skin Hook**
F8-012
Sharp, 2mm, wide jaws,
14.5 cm, 6 3/4"

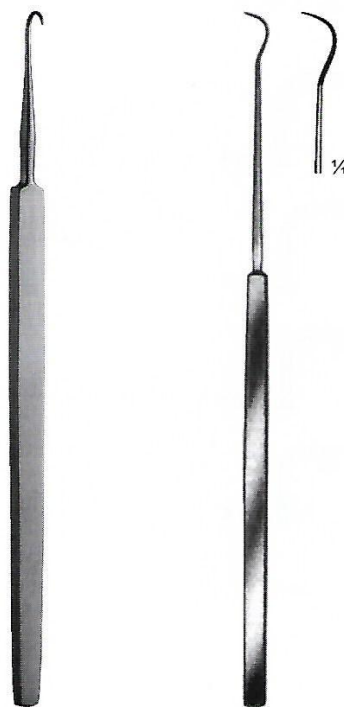

**WIENER HOOK
& Skin Hook**
F8-013
Sharp,
14 cm, 5 1/2"

**TOENNIS HOOK
& Skin Hook**
F8-014
15 cm, 6"
Sharp



F8-015
2 sharp prong
13 cm, 5"
2.25mm diameter
3mm wide

F8-016
4 sharp prong
13 cm, 5"
2mm diameter
5mm wide

F8-017
4 blunt prong
13 cm, 5"
2mm diameter
5mm wide

ROLLET HOOK

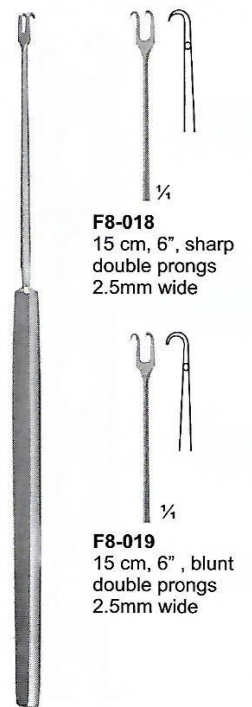

F8-018
15 cm, 6", sharp
double prongs
2.5mm wide

F8-019
15 cm, 6", blunt
double prongs
2.5mm wide

**FREER SKIN
HOOK**



HOOKLET & SKIN HOOKS

Wundhäkchen, Mikrohäkchen
Ganchito, Micro Ganchitos

Crochet, Micro crochets
Divaricatore, Micro Divaricatori



CRILE HOOKLET & SKIN HOOKS
F8-020 20.4 cm, 8"



VON GRAEFE Strabismus & SKIN HOOKS
F8-021 13.0 cm, 5" - A
F8-022 14.0 cm, 5 1/2" - B
F8-023 15.0 cm, 6" - C



WAGENER HOOKLET & SKIN HOOKS
F8-024 14 cm, 5 1/2" - A
F8-025 14 cm, 5 1/2" - B
F8-026 14 cm, 5 1/2" - C
F8-027 14 cm, 5 1/2" - D



DAY HOOKLET & SKIN HOOKS
F8-028 16 cm, 6 1/4" - A
F8-029 16 cm, 6 1/4" - B



LUCAE HOOKLET & SKIN HOOKS
F8-030 14 cm, 5 1/2" - A
F8-031 14 cm, 5 1/2" - B
F8-032 14 cm, 5 1/2" - C

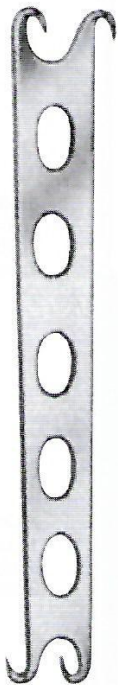

Converse Hook
F8-033
12 cm, 5"



MANNERFELT-LANGENBECK HOOK
F8-034 15 x 6 mm 15.5 cm, 6" Fig.1
F8-035 20 x 6 mm 15.5 cm, 6" Fig.2
F8-036 25 x 6 mm 15.5 cm, 6" Fig.3
F8-037 30 x 8 mm 15.5 cm, 6" Fig.4

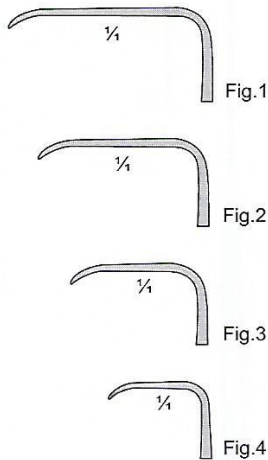

MANNERFELT HOOK
15.5 cm, 6"
large curve, single
hook

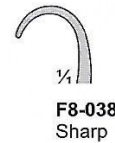

F8-038
Sharp



F8-039
2 prong
Blunt



F8-040
3 prong
Blunt

HOOKLET, RETRACTORS



Wundhäkchen, Wundhaken
Ganchito, Separadores

Crochet, Ecarteurs
Divaricatore, Divaricatori



F8-041
2 prong 18 cm, 7"
Sharp



F8-042
3 prong 18 cm, 7"
Sharp



F8-043
4 prong 18 cm, 7"
Sharp

Tracheal Retractor
18 cm, 7"

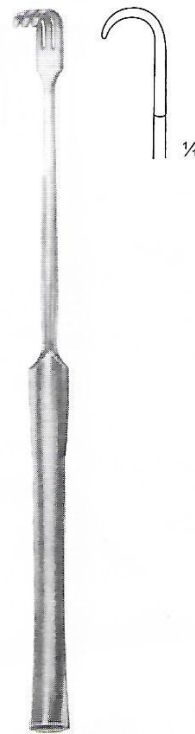

F8-044
2 prong 18 cm, 7"
Blunt



F8-045
3 prong 18 cm, 7"
Blunt



F8-046
4 prong 18 cm, 7"
Blunt

Tracheal Retractor
18 cm, 7"

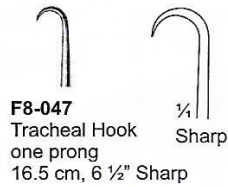

F8-047
Tracheal Hook
one prong
16.5 cm, 6 1/2" Sharp



F8-048
2 prong 16.5 cm,
6 1/2" Sharp



F8-049
3 prong 16.5 cm,
6 1/2" Sharp



F8-050
4 prong 16.5 cm,
6 1/2" Sharp

Trachea Retractor
16.5 cm, 6 1/2"
Sharp

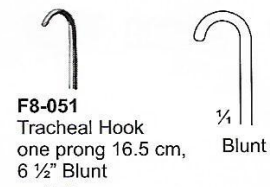

F8-051
Tracheal Hook
one prong 16.5 cm,
6 1/2" Blunt



F8-052
2 prong 16.5 cm,
6 1/2" Blunt



F8-053
3 prong 16.5 cm,
6 1/2" Blunt

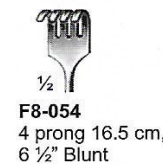

F8-054
4 prong 16.5 cm,
6 1/2" Blunt

Tracheal Retractor
16.5 cm, 6 1/2"
Blunt



WIRE CUTTING INSTRUMENTS

Drahtschneidezangen
Pincès coupantes

Alicates para cortar alambre
Pinze taglia Filo



Side Cutter
F9-798 18.5cm 7 1/4"
Welded carbide jaws
max capacity. 1.6mm 062"



Delicate Wire Cutter
F9-799 12.5cm 4 7/8"
Side cutting w/ carbide inserts
max capacity. 0.7mm 028"



Front & Side Wire Cutter
F9-800 17cm 6 3/4"
Front and side cutting w/ carbide inserts,
double action. Max capacity. 1.6mm 062"



Double Action Wire Cutter
Angled, Side cutting w/ carbide inserts
F9-801 17cm 6 5/8"
max cap 1.6mm 062"
F9-802 21.5cm 8 1/2"
max cap. 2.4mm 3/32"



Flush Wire Cutter
F9-803 17cm 6 3/4"
Front and side cutting w/ carbide inserts,
double action. Max capacity. 1.5mm 059"



Wire Forceps
F9-804 17 cm 6 1/2"
Straight, serrated 5.4 mm tip



HOOKLET, RETRACTORS

Wundhäkchen, Wundhaken
Ganchito, Separadores

Crochet, Ecarteurs
Divaricatore, Divaricatori



Rollet Hooklet Retractors
F8-055
12.5 cm, 4 3/4"



Rollet (Blair) Hooklet Retractors
F8-056
13.5 cm, 5"

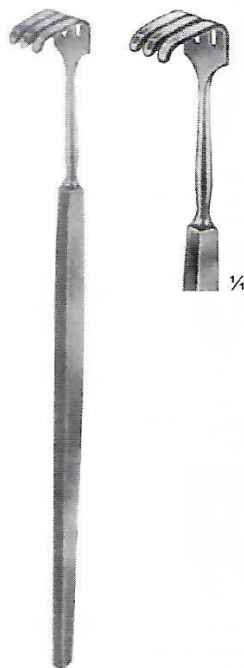

Paul Hooklet Retractors
F8-057
12.5 cm, 4 3/4"



Paul Hooklet Retractors
F8-058
16 cm, 6 1/4"



Miller Retractor
F8-059
13.5 cm, 5 1/4"
Sharp 6 prong

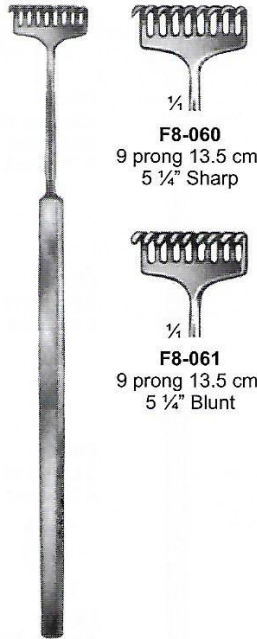

Miller Retractor

F8-060
9 prong 13.5 cm,
5 1/4" Sharp

F8-061
9 prong 13.5 cm,
5 1/4" Blunt



Hooklet Retractors
F8-062
13 cm, 5"



Brom Hooklet Retractors
F8-063
17 cm, 6 3/4"

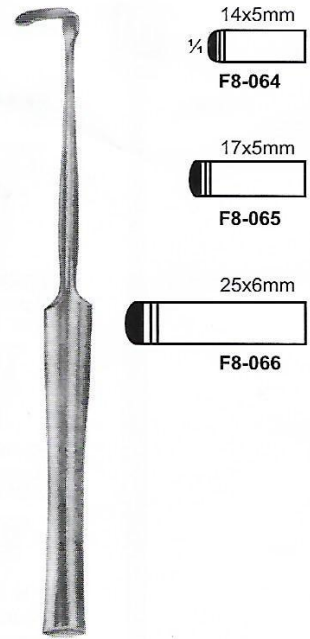

Hooklet Retractors
17 cm, 6 3/4"

14x5mm
F8-064

17x5mm
F8-065

25x6mm
F8-066

HOOCKET, RETRACTORS



Wundhäkchen, Wundhaken
Ganchito, Separadores

Crochet, Ecarteurs
Divaricatore, Divaricatori

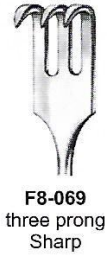
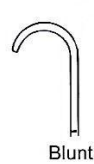

Finger Rake, Retractor
16.5 cm, 6 1/2"



Finger Rake, Retractor
16.5 cm, 6 1/2"



Hooklets, Retractors
16 cm, 6 1/4"



Peck Rake Retractor
16.5 cm, 6 1/2"



HOOKLET, RETRACTORS

Wundhäkchen, Wundhaken
Ganchito, Separadores

Crochet, Ecarteurs
Divaricatore, Divaricatori

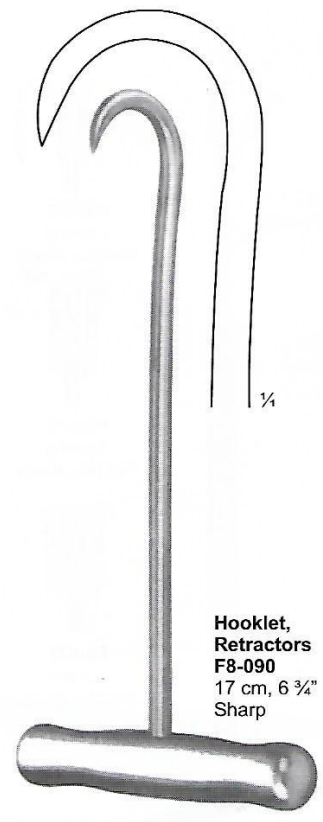
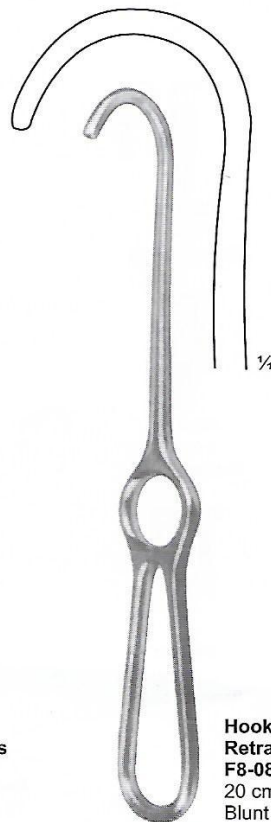
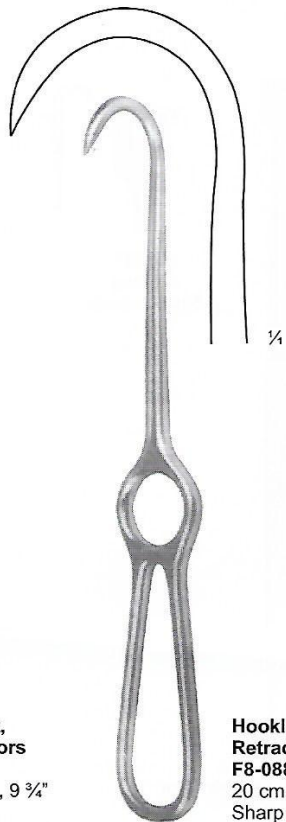
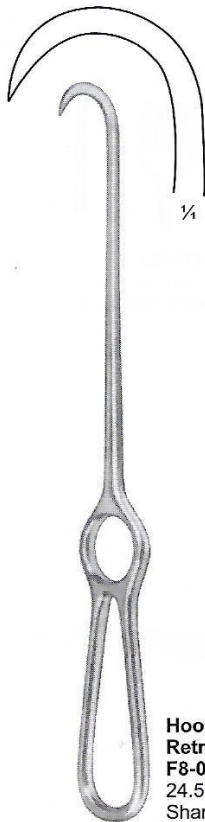
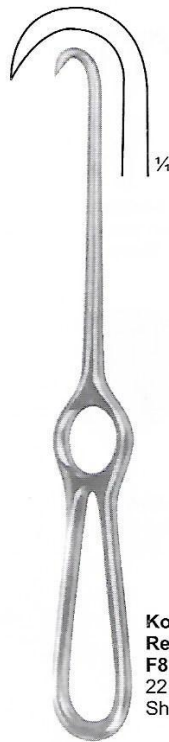

HOOKLET, RETRACTORS



Wundhäkchen, Wundhaken
Ganchito, Separadores

Crochet, Ecarteurs
Divaricatore, Divaricatori



Volkman Retractors
F8-091
23 cm, 9"
Sharp



Volkman Retractors
F8-092
23 cm, 9"
Blunt



Lambotte Retractors
20 cm 18"
F8-093
13 x 235 mm
F8-094
20 x 255 mm
F8-095
27 x 270 mm



Volkman Retractors
11.5 cm, 4 1/2"



Sharp



F8-096
2 prong



F8-097
3 prong



F8-098
4 prong



F8-099
6 prong

Blunt



F8-100
2 prong



F8-101
3 prong



F8-102
4 prong

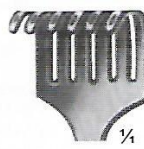

F8-103
6 prong



Murphy Retractors
19.1 cm 7 1/2"
F8-104 3 prongs
F8-105 3 prongs
F8-106 4 prongs
F8-107 4 prongs
Sharp



RETRACTORS

Wundhaken
Separadores

Ecarteurs
Divaricatori



Senn Retractor
F8-108
16 cm 6 1/4"
Blunt

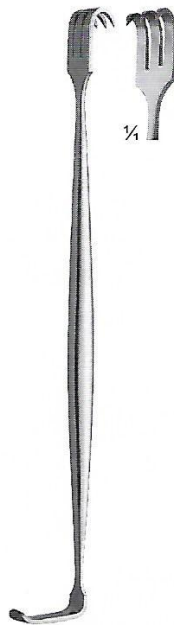

Senn Retractor
F8-109
16 cm 6 1/4"
Sharp



Senn-Mueller Retractor
F8-110
18 x 6 mm
16 cm, 6 1/4"
sharp



Volkman Retractor
F8-111
22 cm 8 3/4"
4 Prongs Sharp



Volkman Retractor
F8-112
22 cm 8 3/4"
4 Prongs Blunt

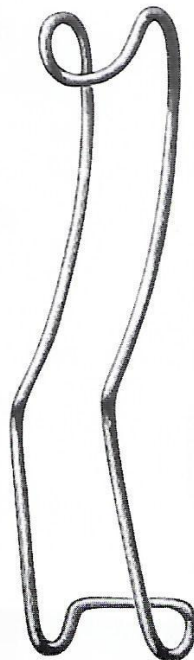

Sternberg Retractor
F8-113 12 cm, 4 3/4"
F8-114 14 cm, 5 1/2"
F8-115 16 cm, 6 1/4"

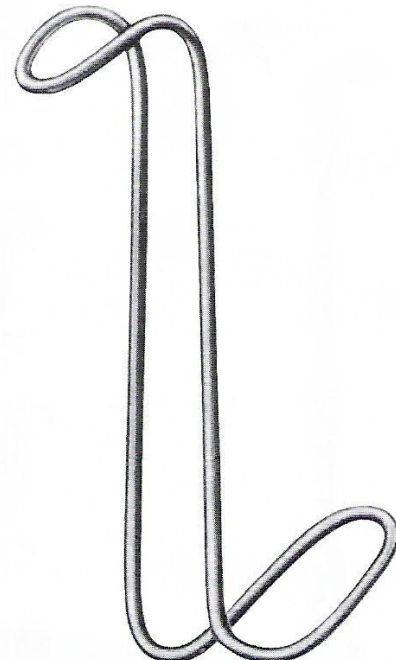

Collin-Hartmann Retractor
F8-116
38 x 28 / 32 x 21 mm 14 cm, 5 1/2"
F8-117
52 x 34 / 36 x 27 mm 16 cm, 6 1/4"

RETRACTORS



Wundhaken
Separadores

Ecarteurs
Divaricatori

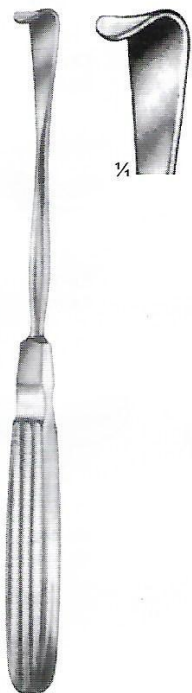

Herzfeld Retractor
F8-118
20 cm, 8"



Strandell-Stille Retractor
F8-119
19 cm, 7 1/2"

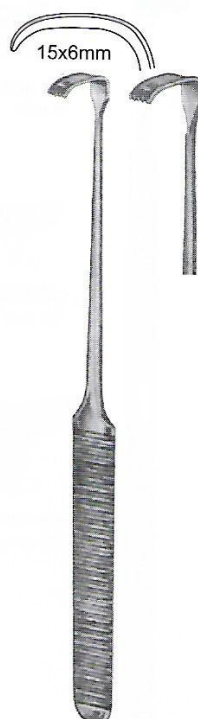

Strandell-Stille Retractor
F8-120
19 cm, 7 1/2"

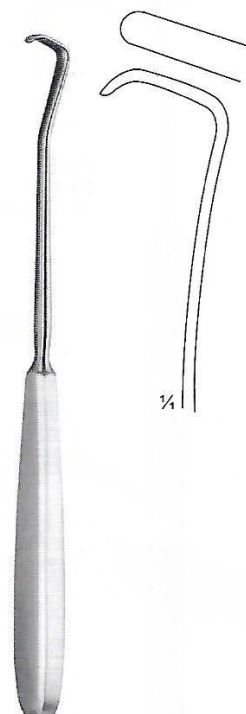

Schoenbore Retractor
F8-121
21 cm, 8 1/4"



Konig Retractor
17 cm, 6 3/4"



F8-122
13 x 13 mm



F8-123
12 x 16 mm

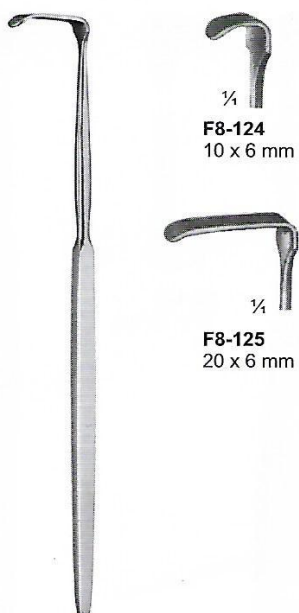

Senn-Green Retractor
15 cm, 6"



F8-124
10 x 6 mm



F8-125
20 x 6 mm



Cottle Retractor
F8-126
15 cm, 6"
10 x 12 mm



Ragnell-Davis Retractor
14 cm, 5 1/2"
F8-127
8 x 4 mm
F8-128
15 x 5.5 mm



HOOKLET

Wundhäkchen
Ganchito

Crochet
Divaricatore



Mannerfelt Hooklet Retractors
15.5 cm, 6"

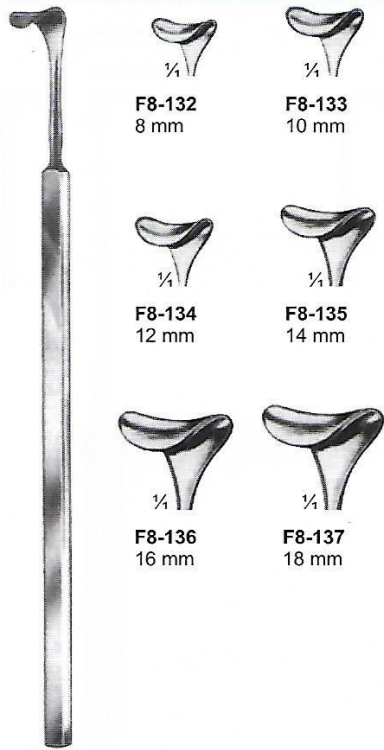

Cushing Hooklet Retractors
20 cm, 8"

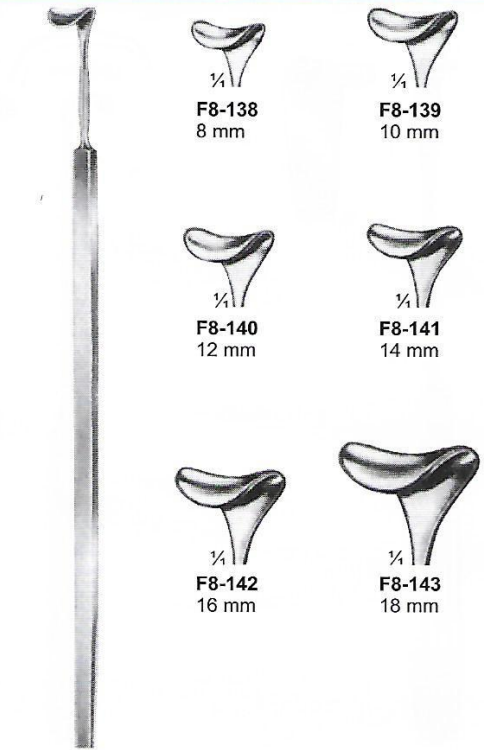

Cushing Hooklet Retractors
24 cm, 9 1/2"

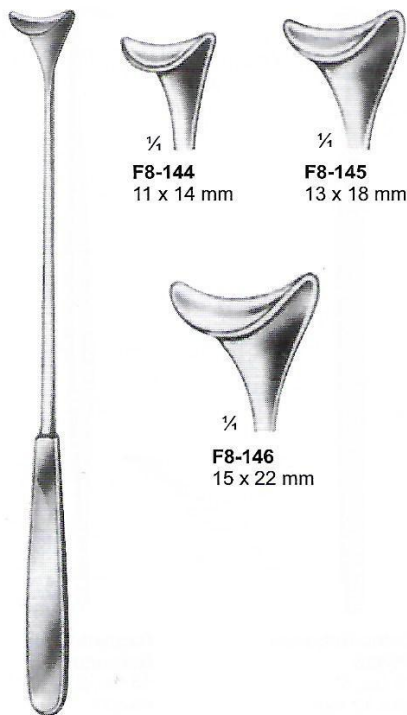

Cushing Hooklet Retractors
24 cm, 9 1/2"

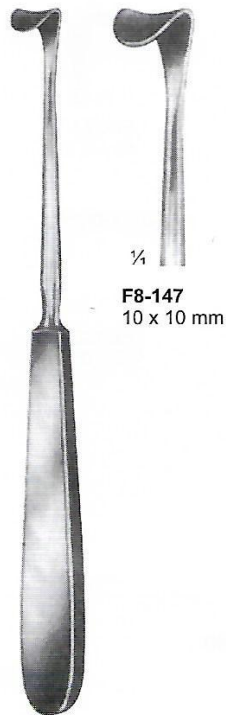

Cushing-Kocher Hooklet Retractors
18 cm, 7"

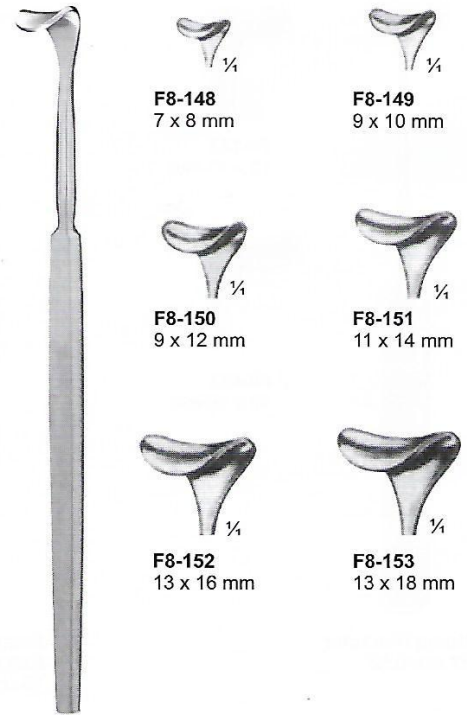

Desmarres Lid Retractors
16 cm, 6 1/4"

RETRACTORS



Wundhaken | Ecarteurs
Separadores | Divaricatori



Kocher Retractor
28 cm 11"

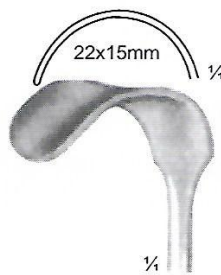

F8-154

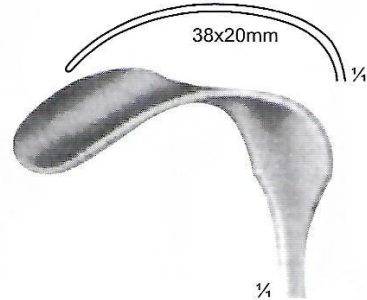

F8-155

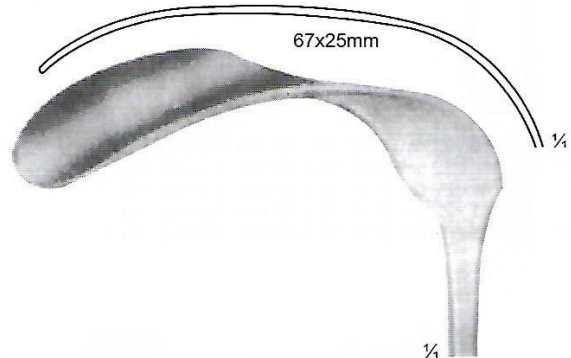

F8-156

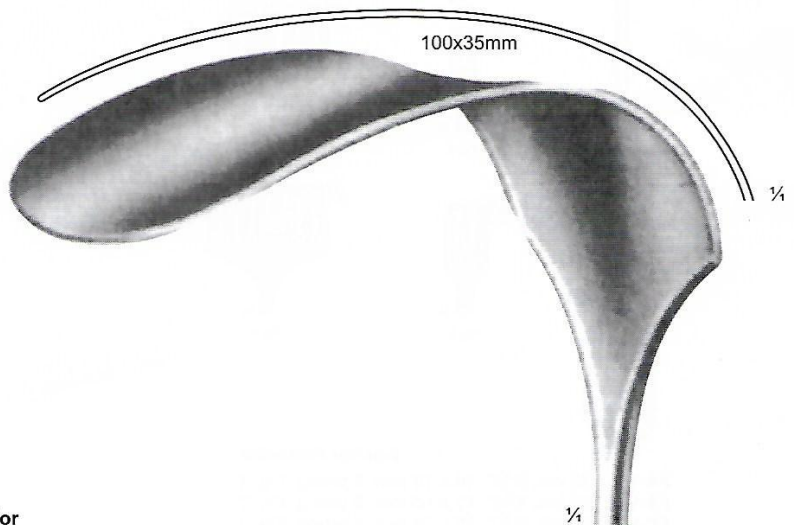

F8-157



RETRACTORS

Wundhaken
Separadores

Ecarteurs
Divaricatori

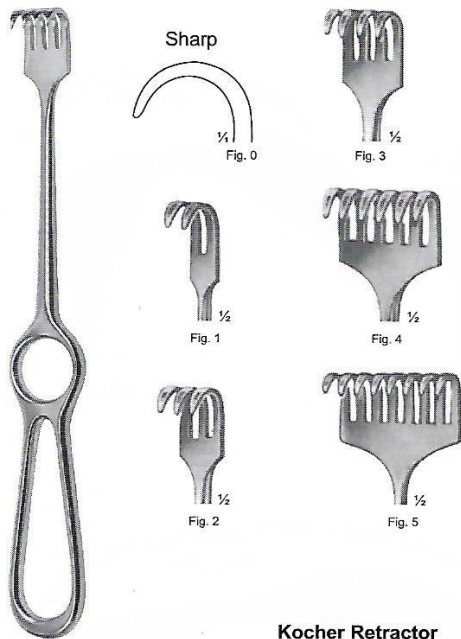

Kocher Retractor

- F8-158 22 cm, 8 3/4" 15 x 10 mm 2 prong Fig. 1
- F8-159 22 cm, 8 3/4" 15 x 15 mm 3 prong Fig. 2
- F8-160 22 cm, 8 3/4" 15 x 20 mm 4 prong Fig. 3
- F8-161 22 cm, 8 3/4" 15 x 30 mm 6 prong Fig. 4
- F8-162 22 cm, 8 3/4" 15 x 40 mm 8 prong Fig. 5

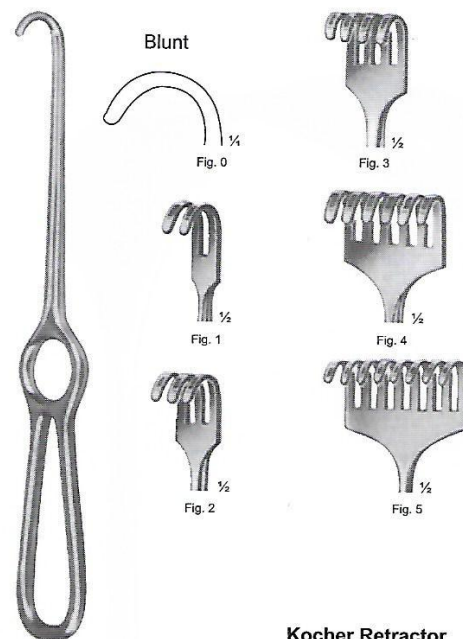

Kocher Retractor

- F8-163 22 cm, 8 3/4" 15 x 10 mm 2 prong Fig. 1
- F8-164 22 cm, 8 3/4" 15 x 15 mm 3 prong Fig. 2
- F8-165 22 cm, 8 3/4" 15 x 20 mm 4 prong Fig. 3
- F8-166 22 cm, 8 3/4" 15 x 30 mm 6 prong Fig. 4
- F8-167 22 cm, 8 3/4" 15 x 40 mm 8 prong Fig. 5

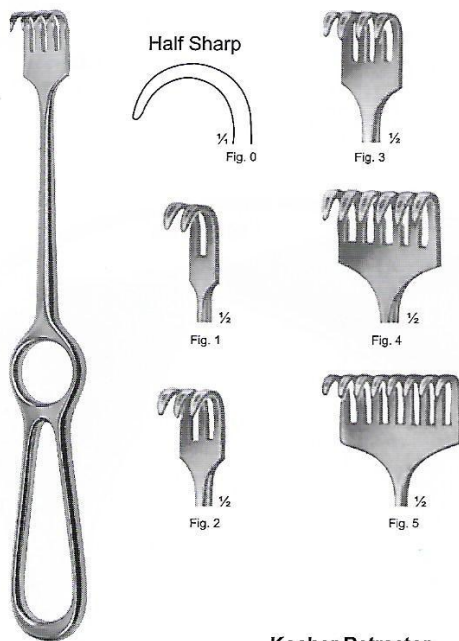

Kocher Retractor

- F8-168 22 cm, 8 3/4" 15 x 10 mm 2 prong Fig. 1
- F8-169 22 cm, 8 3/4" 15 x 15 mm 3 prong Fig. 2
- F8-170 22 cm, 8 3/4" 15 x 20 mm 4 prong Fig. 3
- F8-171 22 cm, 8 3/4" 15 x 30 mm 6 prong Fig. 4
- F8-172 22 cm, 8 3/4" 15 x 40 mm 8 prong Fig. 5

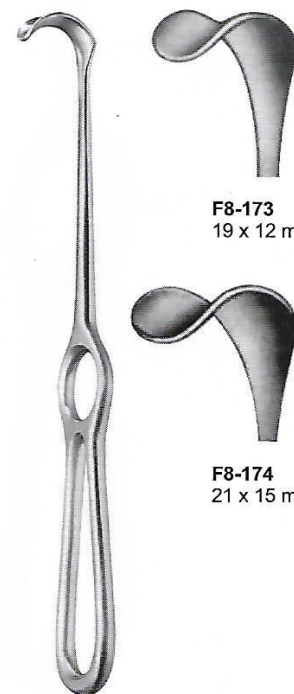

Kocher Retractor

19 cm, 7 1/2"

RETRACTORS



Wundhaken | Ecarteurs
Separadores | Divaricatori



**Kocher-Langenbeck
Retractor**
21.5 cm, 8 1/2"



F8-175
25 x 6 mm



F8-176
35 x 8 mm



F8-177
35 x 11 mm



F8-178
35 x 15 mm



F8-179
40 x 11 mm



F8-180
55 x 11 mm



F8-181
70 x 14 mm

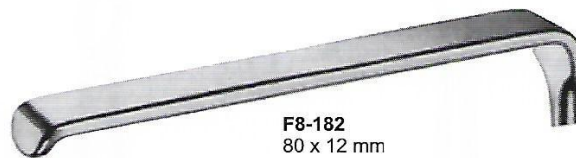

F8-182
80 x 12 mm

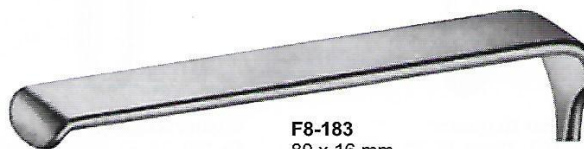

F8-183
80 x 16 mm



RETRACTORS

Wundhaken
Separadores

Ecarteurs
Divaricatori

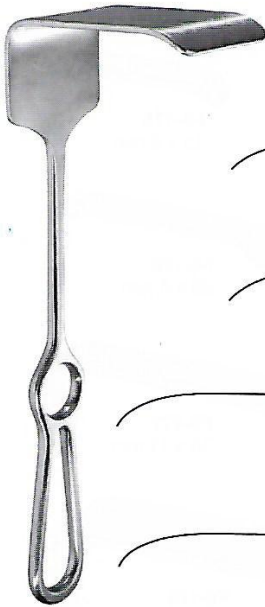

Kocher Retractor
23 cm, 9"

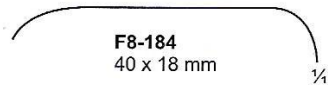

F8-184
40 x 18 mm

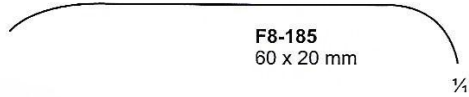

F8-185
60 x 20 mm

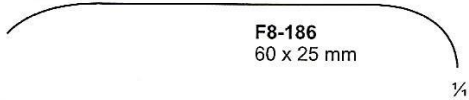

F8-186
60 x 25 mm



F8-187
75 x 30 mm



F8-188
75 x 40 mm



Kocher Retractor
22 cm, 8 1/2"
F8-189 40 x 10 mm
F8-190 40 x 15 mm
F8-191 40 x 20 mm

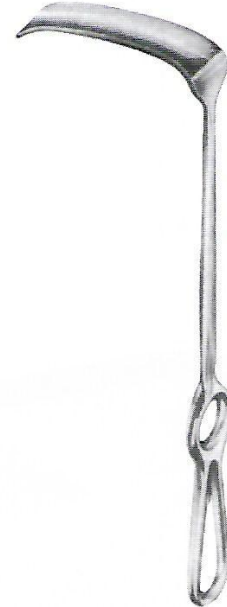

Kocher Retractor
F8-192
22.5 cm 8 3/4"
70 x 25 mm



Kocher Retractor
F8-193 23 cm, 9" 35 x 18 mm
F8-194 23 cm, 9" 60 x 20 mm
F8-195 23 cm, 9" 60 x 25 mm
F8-196 23 cm, 9" 75 x 30 mm
F8-197 23 cm, 9" 75 x 40 mm

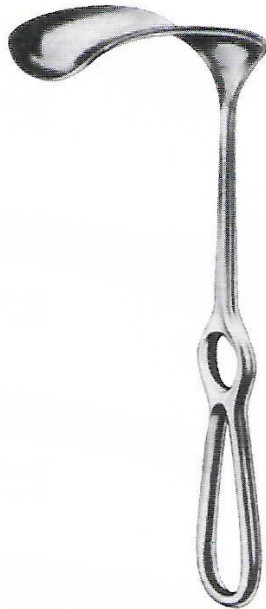

Kocher Retractor
F8-198 25 cm, 9 3/4" 80 x 45 mm
F8-199 25 cm, 9 3/4" 80 x 55 mm
F8-200 25 cm, 9 3/4" 80 x 65 mm

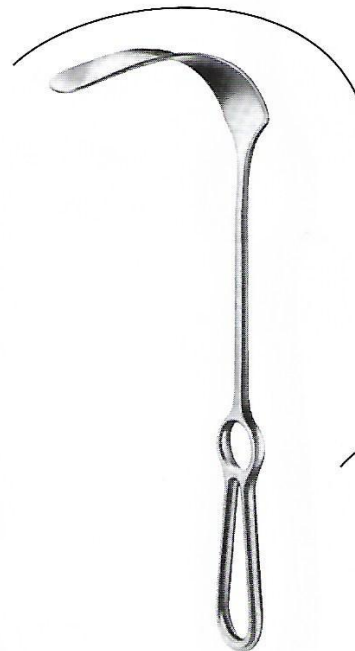

Kocher-Wagner Retractor
28 cm, 11"



F8-201
22 x 15 mm



F8-202
38 x 20 mm



F8-203
67 x 25 mm

RETRACTORS



Wundhaken
Separadores

Ecarteurs
Divaricatori



**Langenbeck Retractor
F8-204**
21.5 cm 8 1/2"
Handle vertical
to the blade

**Langenbeck
Retractor
F8-208**
20.4 cm, 8"

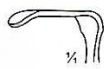

F8-205
20 x 7 mm



F8-206
30 x 7 mm



F8-207
30 x 11 mm



F8-208
30 x 15 mm

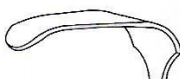

F8-209
30 x 20 mm



F8-210
44 x 10 mm



F8-211
44 x 15 mm

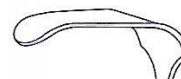

F8-212
45 x 20 mm

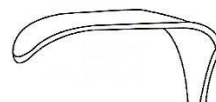

F8-213
50 x 20 mm

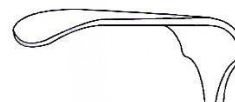

F8-214
60 x 20 mm



**Langenbeck Retractor
F8-215**
21 cm 8 1/4"
38 x 9mm



**Langenbeck Retractor
F8-216**
24 cm, 8 1/4"



F8-217
35 x 7mm



F8-218
35 x 11mm



F8-219
35 x 15mm

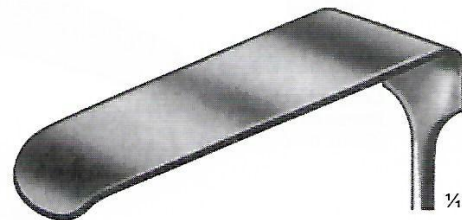

F8-219
35 x 20mm



RETRACTORS

Wundhaken | Ecarteurs
Separadores | Divaricatori



**Langenbeck
Retractor**
22 cm, 8 ½"



F8-220
25 x 6 mm



F8-221
35 x 8 mm

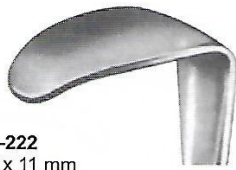

F8-222
35 x 11 mm



F8-223
35 x 15 mm



F8-224
41 x 11 mm



F8-225
55 x 11 mm



F8-226
70 x 14 mm



**Langenbeck
Retractor**
22 cm, 8 ½"

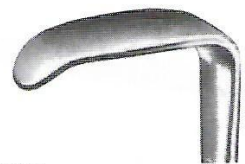

F8-227
25 x 6 mm



F8-228
35 x 8 mm



F8-229
35 x 11 mm



F8-230
35 x 15 mm

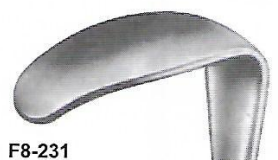

F8-231
41 x 11 mm

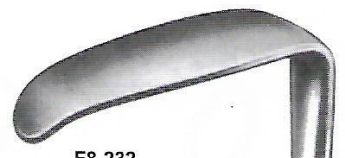

F8-232
55 x 11 mm

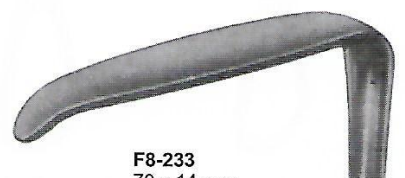

F8-233
70 x 14 mm

RETRACTORS



Wundhaken
Separadores

Ecarteurs
Divaricatori

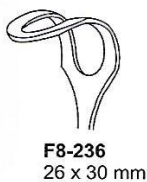
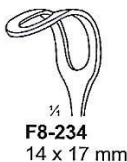

Middeldorpf Retractor
21 cm, 8 1/4"

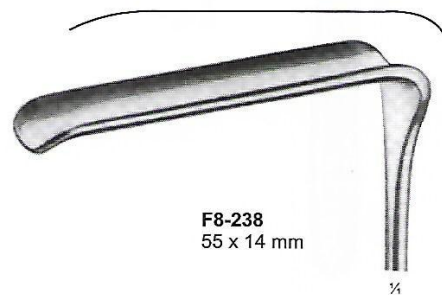
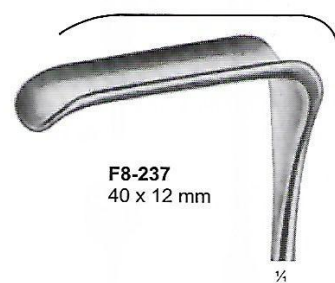

Caspar Retractor
21 cm, 8 1/4"

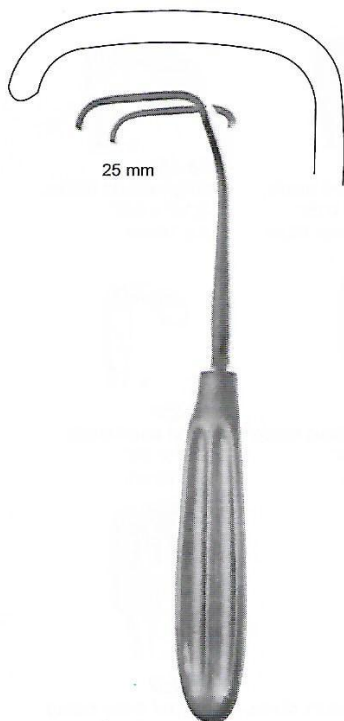

Ollier Retractor
F8-239
18.5 cm, 7 1/4"



Lahey Goiter Retractor
F8-240 20.4 cm, 8"
Right angle blade, length
1 inch (2.5cm). With lip.



Lahey Retractor
F8-241
19 cm, 7 1/2"



RETRACTORS

Wundhaken | Ecarteurs
Separadores | Divaricatori



Tendon Hooks Retractor
F8-242 12 x 6 mm Fig. 1
F8-243 12 x 11 mm Fig. 2
17.5 cm, 7"



Klapp Retractor
F8-244
17.5 cm, 7"
15 x 11 mm

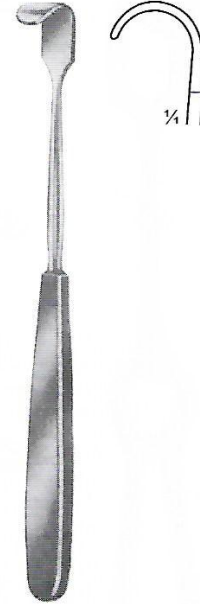

Little Retractor
F8-245
20 cm, 8"
12x14 mm



Wassmund Retractor
F8-246
20 cm, 8"
33 x 20mm



Meyerdig Finger Retractor
18 cm, 7"



F8-247
long blunt blade,
1/4" x 11/16"
6 x 17 mm Blunt



F8-250
long toothed blade,
3/16" x 5/8"
5 x 16mm



F8-248
short toothed blade
1/8" x 1/4"
3 x 6 mm



F8-251
short blunt blade,
1/8" x 3/8"
3 x 10mm



F8-249
curved blunt blade,
1/8" x 3/8"
3 x 8mm
Saddle Shaped



F8-252
curved three prong
sharp blade,
3/8" x 5/32"
10 x 4mm

RETRACTORS



Wundhaken | Ecarteurs
Separadores | Divaricatori

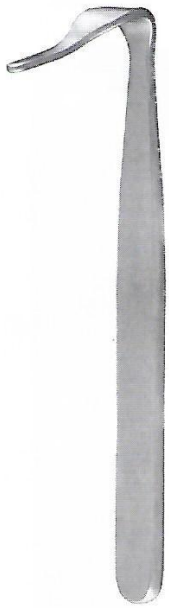

Blount Knee Retractor
F8-253
17.5 cm, 6 3/4"
42 x 4 mm

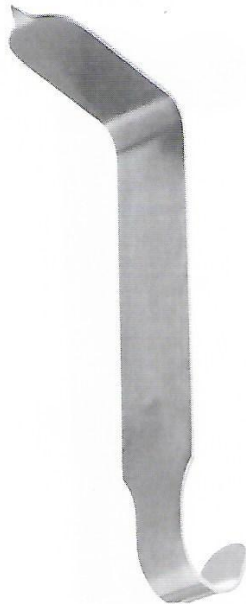

Taylor Spinal Retractors
F8-254 16.5 cm, 6 1/2"
75 x 30 mm / 100 x 30 mm



Luer Retractor
F8-255 11 cm, 4 1/4"
10 x 8 mm / 12 x 11 mm



Rose Retractor
F8-256 13 cm, 5"
12 x 12 mm /
12 x 15 mm

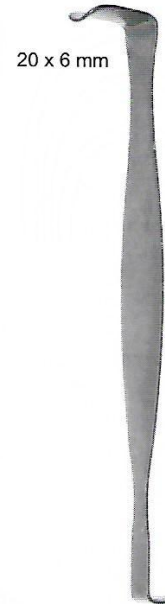

20 x 6 mm

12 x 4 mm

Crile Retractor
F8-257 11 cm, 4 1/4"
12 x 4 mm /
20 x 6 mm



Mathieu Retractor
Set 2 pcs.
F8-258 20 cm, 8"
47 x 13 / 46 x 26 mm
F8-259 20 cm, 8"
42 x 13 / 42 x 26 mm

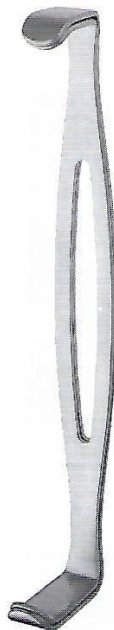

Us-Army Retractor
Set 2 pcs.
F8-260 21.5 cm, 8 1/2"
28 x 15 / 42 x 15 mm
F8-261 21.5 cm, 8 1/2"
25 x 15 / 38 x 15 mm



Richardson Eastman Retractor
F8-262
26 cm, 10 1/4"
small



Richardson Eastman Retractor
F8-263
28 cm, 11"

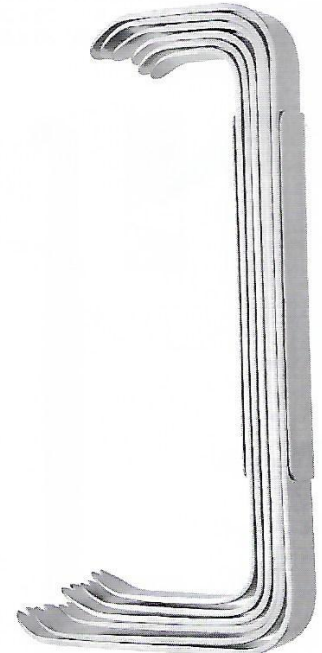

Sofield Retractor
F8-264
set of 6 pec.



RETRACTORS

Wundhaken
Separadores

Ecarteurs
Divaricatori

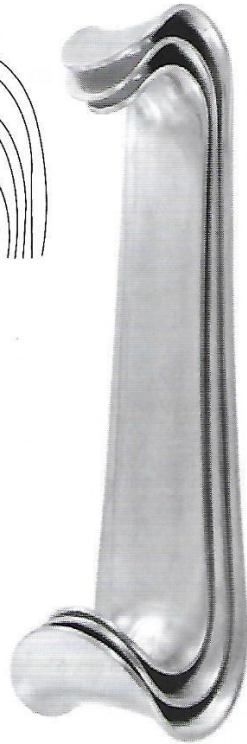
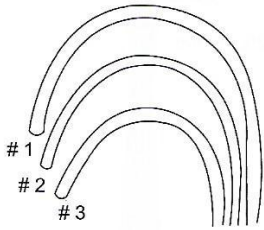

Roux Retractor

Set 3 pcs. consisting of

- # 1 **F8-265** 14 cm, 5 1/2" 24 x 20 / 30 x 28 mm
- # 2 **F8-266** 15 cm, 6" 29 x 26 / 36 x 36 mm
- # 3 **F8-267** 17 cm, 6 3/4" 33 x 29 / 38 x 43 mm

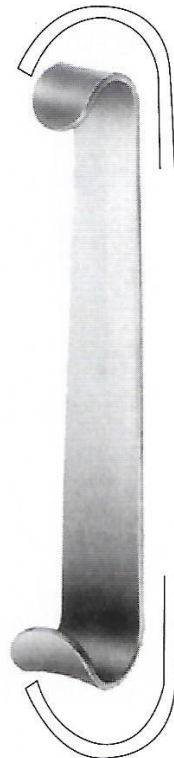

Baby-Roux Retractor

- F8-268** 13 cm, 5" 15 x 15 mm / 18 x 21 mm



Roux Retractor

- F8-269** 16.5 cm, 6 1/2" 28 x 23 mm / 43 x 23 mm

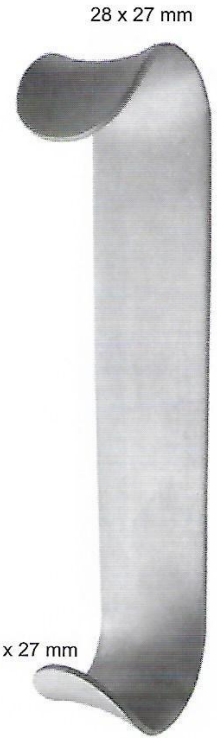

Roux Retractor

- F8-270** 18.5 cm, 7 1/4" 28 x 27 mm / 45 x 27 mm

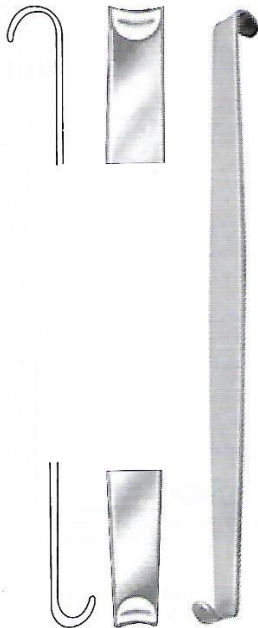

Mini-Roux Retractor

- F8-271** 14 cm, 5 1/2"



Roux-Magnus Retractor

- F8-272** 15 cm, 6" 20 x 22 mm / 25 x 38 mm



Roux-Magnus Retractor

- F8-273** 16 cm, 6 1/4" 23 x 26 mm / 29 x 38 mm

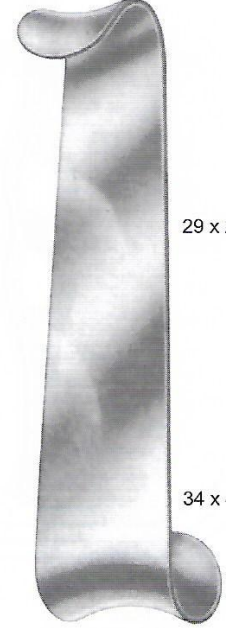

Roux-Magnus Retractor

- F8-274** 17 cm, 6 3/4" 29 x 29 mm / 34 x 44 mm

RETRACTORS



Wundhaken | Ecarteurs
 Separadores | Divaricatori

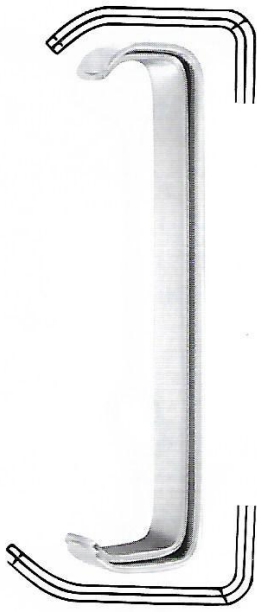

Farabeuf Retractor
 Set 2 Pcs.
F8-275 13 cm, 5"
 30 x 10 / 34 x 13 mm
F8-276 13 cm, 5"
 26 x 10 / 30 x 13 mm

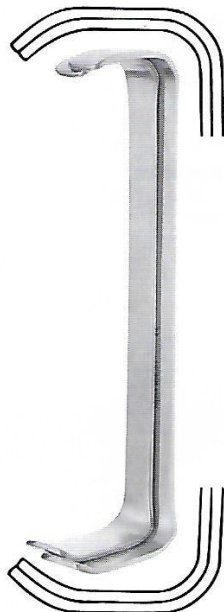

Farabeuf Retractor
 Set 2 Pcs.
F8-277 15 cm, 6"
 27 x 16 / 30 x 16 mm
F8-278 15 cm, 6"
 23 x 16 / 26 x 16 mm



Farabeuf Retractor
F8-278A Baby (7x100mm)
F8-278B infantil (10x120mm)
F8-278C Adult (13x125mm)
F8-278D Adult (15x150mm)
F8-278E Extra Large(20x180mm)

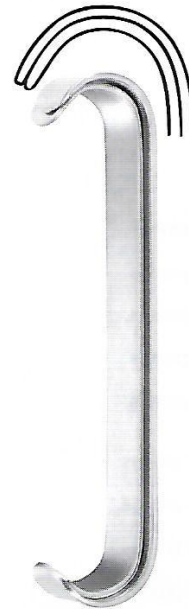

Parker Retractor
 Set 2 pcs.
F8-279 13.5 cm, 5 1/4"
 22 x 15 mm / 22 x 15 mm
F8-280
 18.4 cm 7 1/4"

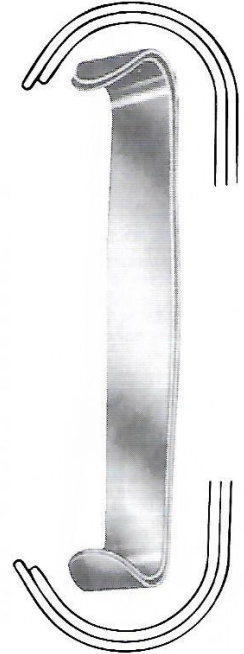

Parker Retractor
F8-281 13.5 cm, 5 1/4"
 18 x 15 mm / 19 x 15 mm

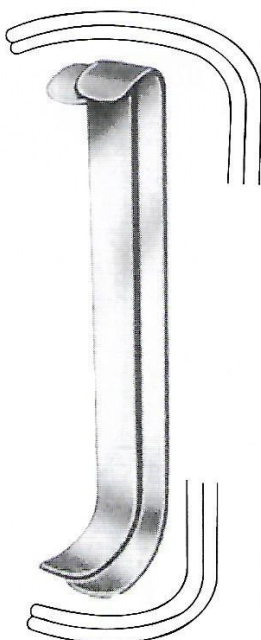

Collin Retractor
 Set 2 pcs.
F8-282 16.5 cm, 6 1/2"
 25 x 12 / 35 x 16 mm
F8-283 16.5 cm, 6 1/2"
 20 x 12 / 30 x 16 mm

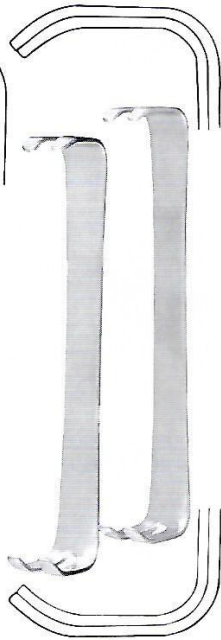

Mayo-Collin Retractor
 Set 2 pcs.
F8-284 15 cm, 6"
 28 x 18 / 25 x 18 mm

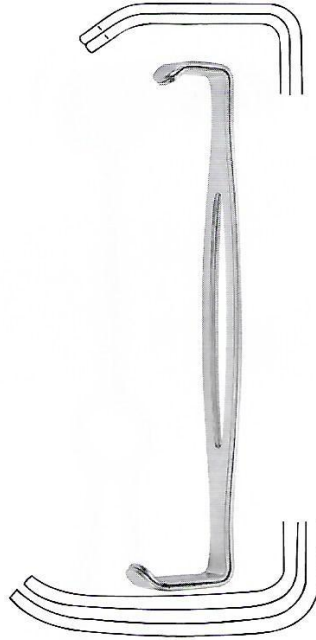

Parker-Langenbeck Retractor
 Set of 2 Pcs.
F8-285 21.5 cm, 8 1/2" 25 x 15 mm fig. 2
F8-286 21.5 cm, 8 1/2" 21 x 15 mm fig. 1
F8-287 21.5 cm, 8 1/2" 40 x 15 mm fig. 1
F8-288 21.5 cm, 8 1/2" 46 x 15 mm fig. 2



Parker-Mott Retractor
F8-289
 16 cm 6 1/4"
 68 x 24 / 74 x 24 mm



RETRACTORS

Wundhaken
Separadores

Ecarteurs
Divaricatori



- F8-290**
Blunt, 2 prongs.
- F8-291**
Blunt, 3 prongs.
- F8-292**
Blunt, 4 prongs.
- F8-293**
Blunt, 5 prongs.
- F8-294**
Blunt, 6 prongs.
- F8-295**
Sharp, 2 prongs.
- F8-296**
Sharp, 3 prongs.
- F8-297**
Sharp, 4 prongs.
- F8-298**
Sharp, 5 prongs.
- F8-299**
Sharp, 6 prongs.

Volkman Retractors
Long Pattern
22.2 cm, 8 1/4"



Koerte Retractor
F8-301 24 cm, 9 1/2"
26 x 40 mm
sharp

Koerte Retractor
F8-300 24 cm, 9 1/2"
26 x 40 mm
blunt

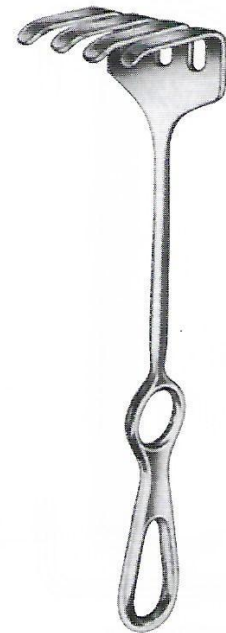

Koerte Retractor
F8-302 23 cm, 9"
46 x 55 mm
blunt



Koerte Retractor
F8-303 28 cm, 11"
25 x 40 mm
semi-sharp



Koerte Retractor
F8-304 23 cm, 9"
Blunt



Korte-Wagner
Retractor
F8-305 28 cm, 11"
Sharp

RETRACTORS



Wundhaken | Ecarteurs
Separadores | Divaricatori

F8-306
115 x 65 mm



F8-307
115 x 38 mm

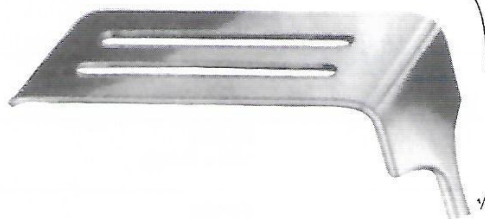

F8-308
82 x 22 mm



F8-309
130 x 38 mm

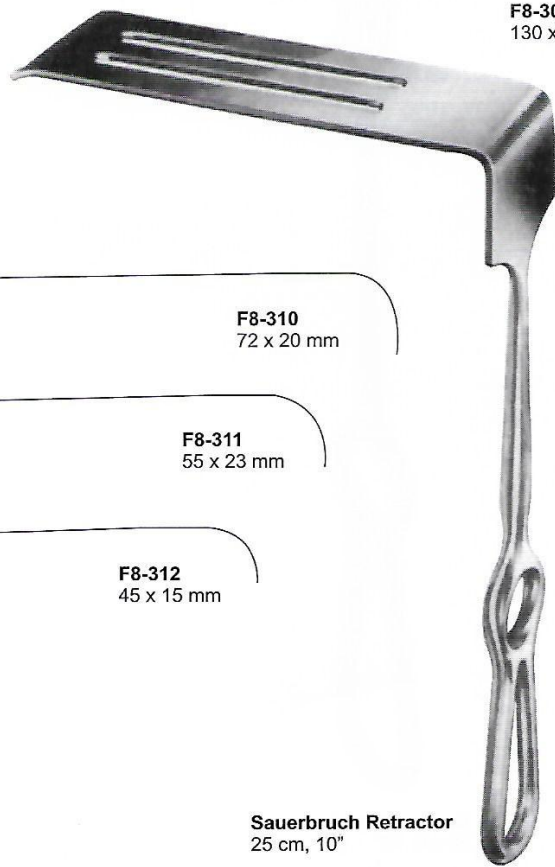

Coryllos Retractor
22.5 cm, 8 3/4"



F8-310
72 x 20 mm

F8-311
55 x 23 mm

F8-312
45 x 15 mm

Sauerbruch Retractor
25 cm, 10"

Davidson Retractor
F8-313 16 cm, 6 1/4" 75 x 50 mm
F8-314 16 cm, 6 1/4" 75 x 90 mm





RETRACTORS

Wundhaken | Ecarteurs
Separadores | Divaricatori

F8-315
180 x 30 mm

F8-316
160 x 30 mm

F8-317
140 x 30 mm

F8-318
130 x 30 mm

F8-319
120 x 25 mm

F8-320
100 x 25 mm

F8-321
80 x 20 mm



Bruner Retractor
25 cm, 10"

RETRACTORS



Wundhaken | Ecarteurs
 Separadores | Divaricatori

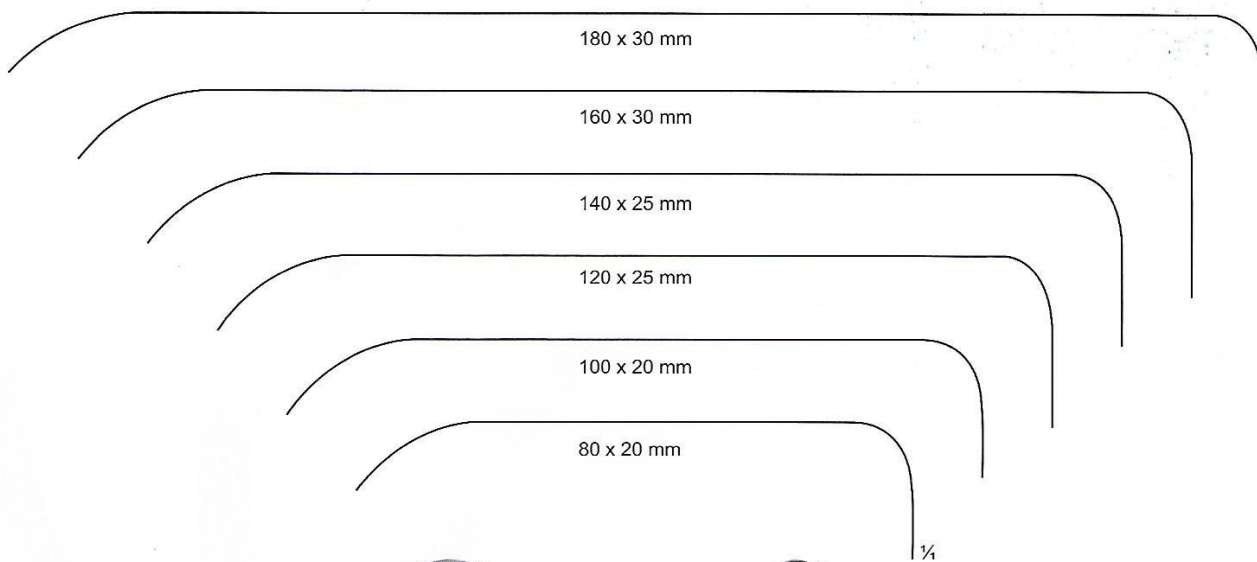

- F8-322 80 x 20 mm
- F8-323 100 x 20 mm
- F8-324 120 x 25 mm
- F8-325 140 x 25 mm
- F8-326 160 x 30 mm
- F8-327 180 x 30 mm

Brunner Retractor
 24 cm, 9 1/2"



- F8-328 80 x 20 mm
- F8-329 100 x 20 mm
- F8-330 120 x 25 mm
- F8-331 140 x 25 mm
- F8-332 160 x 30 mm
- F8-333 180 x 30 mm

Brunner Retractor
 24 cm, 9 1/2"



RETRACTORS

Wundhaken
Separadores

Ecarteurs
Divaricatori



**Deaver Retractor
F8-334**
18 cm, 7"

**Deaver Retractor
F8-335**
21.5 cm, 8 ½"

**Deaver Retractor
F8-336**
23 cm, 9"

**Deaver Retractor
F8-337**
30 cm, 11 ¾"

**Deaver Retractor
F8-338**
33 cm, 13"

**Deaver Retractor
F8-339**
36 cm, 13 ½"

RETRACTORS



Wundhaken | Ecarteurs
Separadores | Divaricatori

38 mm



Deaver Retractor
F8-340
30 cm, 11 3/4"

50 mm



Deaver Retractor
F8-341
30 cm, 11 3/4"

75 mm



Deaver Retractor
F8-342
30 cm, 11 3/4"

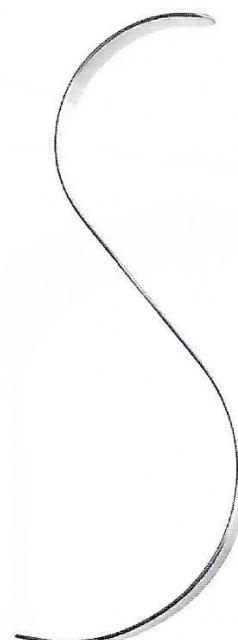

S-Shaped Retractor
F8-343
21 cm, 8 1/4"
12 mm



RETRACTORS

Wundhaken
Separadores

Ecarteurs
Divaricatori

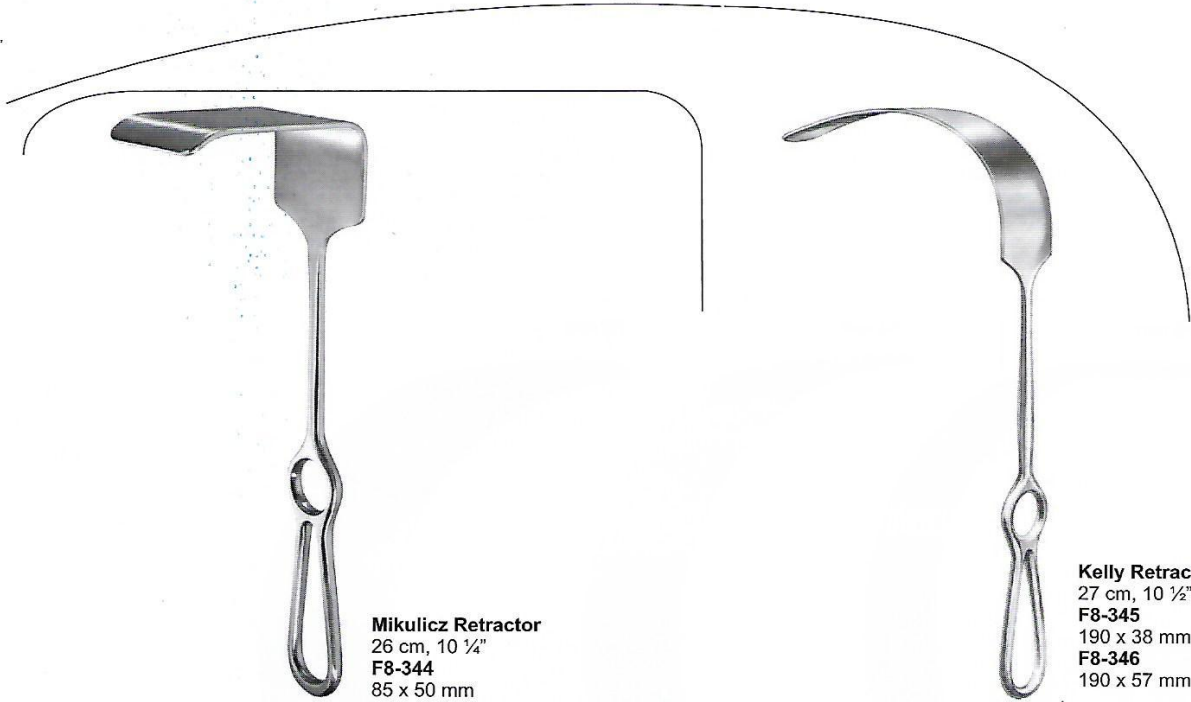

Mikulicz Retractor
26 cm, 10 ¼"
F8-344
85 x 50 mm

Kelly Retractor
27 cm, 10 ½"
F8-345
190 x 38 mm
F8-346
190 x 57 mm



Mikulicz Retractor
26 cm, 10 ¼"
F8-347
95 x 35 mm

Mikulicz Retractor
26 cm, 10 ¼"
F8-348
120 x 50 mm
F8-349
150 x 50 mm

RETRACTORS



Wundhaken
Separadores

Ecarteurs
Divaricatori



Cheek-And Lip Retractor
19 cm, 7 1/2"
F8-350
Movable

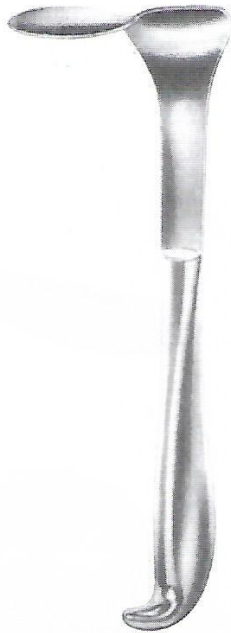

Tuffier Retractor
23 cm, 9"
F8-351 55 x 63 mm



Bennet Retractor
F8-351A
24cm

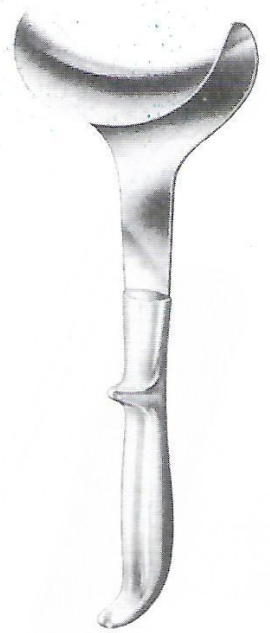

Doyen Retractor
25 cm, 10"
F8-352 50 x 85 mm



Fritch Retractor
F8-353
2.75 x 2 mm



Fritch Retractor
24 cm, 9 1/2"
F8-354 35 x 40 mm



Fritch Retractor
F8-355 24 cm, 9 1/2" 30 x 30 mm
F8-356 24 cm, 9 1/2" 32 x 40 mm
F8-357 24 cm, 9 1/2" 40 x 50 mm
F8-358 24 cm, 9 1/2" 40 x 60 mm
F8-359 24 cm, 9 1/2" 45 x 75 mm
F8-360 24 cm, 9 1/2" 65 x 85 mm



RETRACTORS

Wundhaken
Separadores

Ecarteurs
Divaricatori

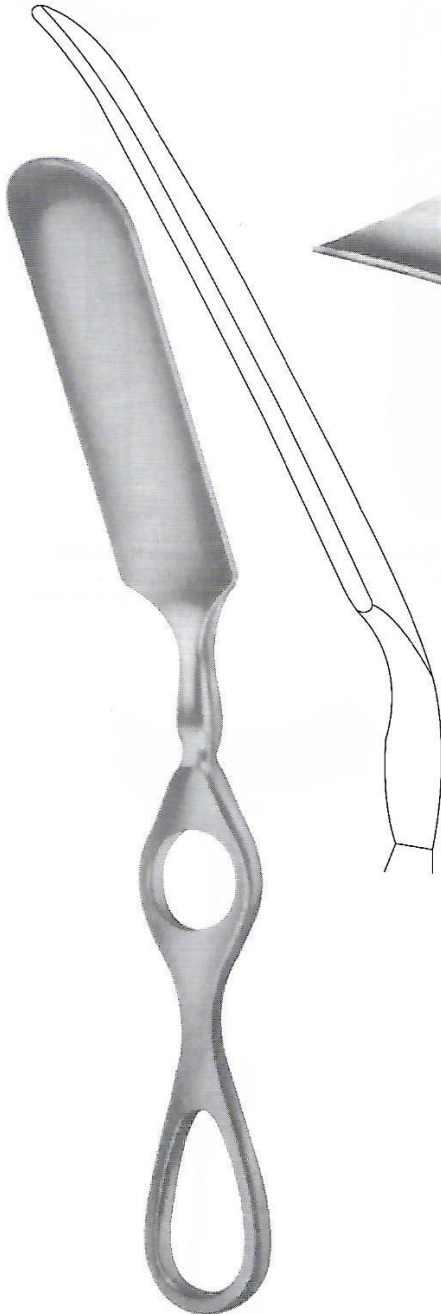

Mikulicz Retractor
F8-361 29 cm 11.5"

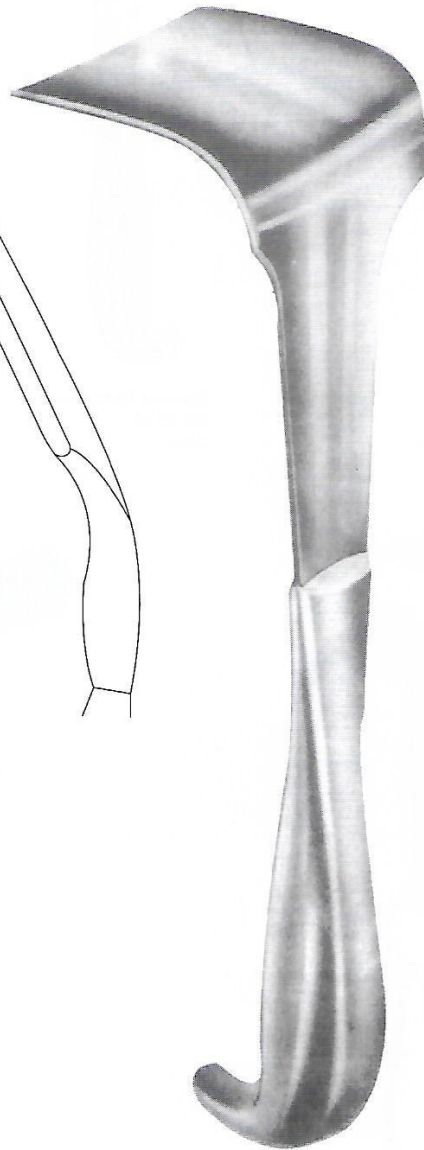

Tuffier Retractor
F8-362 23 cm 9"
64 x 60mm



Harrington Retractor
32 cm, 12 3/4"
F8-363
127 x 40 mm
F8-364
127 x 62 mm

RETRACTORS



Wundhaken | Écarteurs
Separadores | Divaricatori



Harrington Extra Deep Retractor
F8-365 30.0cm 11 3/4"
Hollow handle, 5.7cm 2 1/4"
width x 20.5cm 8" depth blade

Harrington Splanchnic Retractor
F8-366 31.5cm 12 1/2"
Hollow handle, 3.8cm 1 1/2"
width x 12.0cm 4 3/4"
depth blade

Debakey-Cooley Retractor
F8-367 31.0cm 12 1/4"
Hollow handle, 5.7cm 2 1/4"
width x 18.4cm 7 1/4"
depth blade



RETRACTORS, VEIN HOOKS

Wundhaken, Venenhäkchen
Separadores, Ganchitos Para venas

Ecarteurs, Ecarteurs sous
Divaricatori, Divaricatori per veni

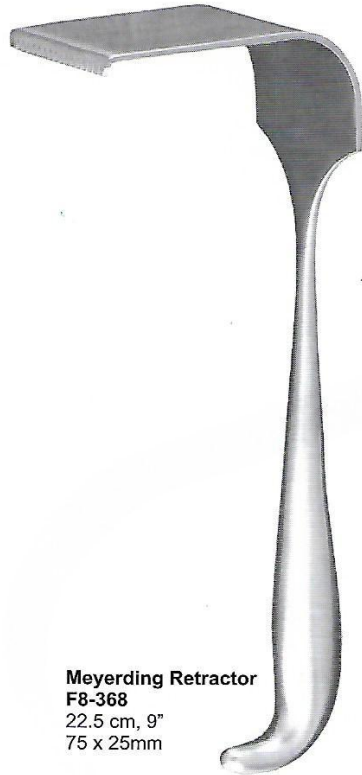

Meyerding Retractor
F8-368
22.5 cm, 9"
75 x 25mm

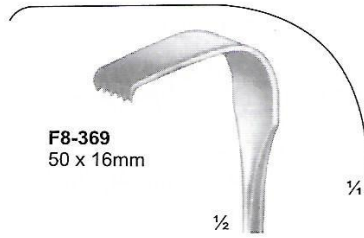

F8-369
50 x 16mm

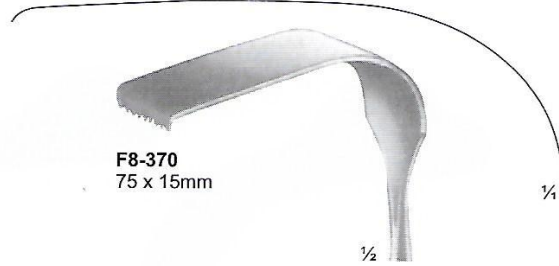

F8-370
75 x 15mm

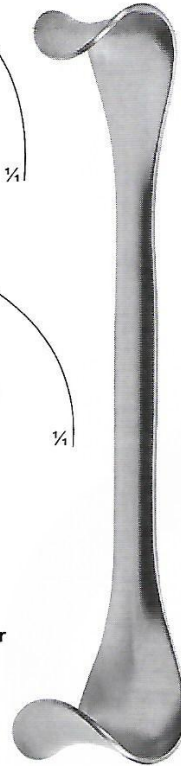

Goelet Retractor
F8-371
19 cm 7 1/2"
Double Ended

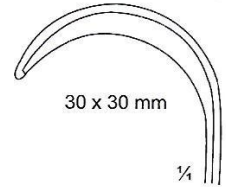

30 x 30 mm

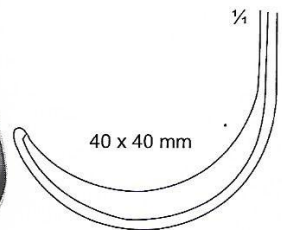

40 x 40 mm



Kaye-Millard Retractor
F8-372
8 cm, 3 1/4"



Richardson/Kelly Retractor
24 cm, 9 1/2"



F8-373
5 x 31mm



F8-374
19 x 51mm

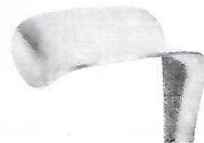

F8-375
38 x 51mm

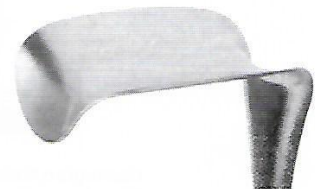

F8-376
64 x 76mm

RETRACTORS



Wundhaken | Ecarteurs
 Separadores | Divaricatori



Ross Retractor
 25.5 cm, 10"



F8-377
 Fig.01



F8-378
 Fig.02



F8-379
 Fig.03



F8-380
 Fig.04



F8-381
 Fig.05



F8-382
 Fig.06



Weinberg Vagotomy Retractor (joe's Hoe)
F8-383
 20 cm, 8"
 Blade 102 x 165 mm wide



Turner-Doyen Retractors
 23.5 cm 9 1/2"
F8-384
 Blade 140 x 60 mm wide
F8-385
 Blade 76 x 140 mm wide
F8-386
 Blade 165 x 76 mm wide

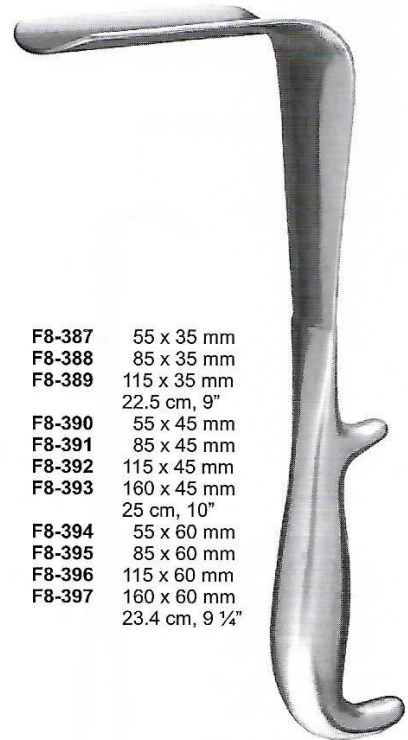

- F8-387** 55 x 35 mm
- F8-388** 85 x 35 mm
- F8-389** 115 x 35 mm
- 22.5 cm, 9"
- F8-390** 55 x 45 mm
- F8-391** 85 x 45 mm
- F8-392** 115 x 45 mm
- F8-393** 160 x 45 mm
- 25 cm, 10"
- F8-394** 55 x 60 mm
- F8-395** 85 x 60 mm
- F8-396** 115 x 60 mm
- F8-397** 160 x 60 mm
- 23.4 cm, 9 1/4"

Doyen Vaginal Retractors



RETRACTORS

Wundhaken
Separadores

Ecarteurs
Divaricatori



Sawyer Retractors

F8-398

Small Blade 70 mm x 19 mm wide
23 cm 9"

F8-399

Medium Blade 82 mm x 29 mm wide
25 cm 10"

F8-400

Large Blade 22 mm X 64 mm
27.9 cm 11"

F8-401

Large Blade 38 mm X 89 mm
27.9 cm 11"

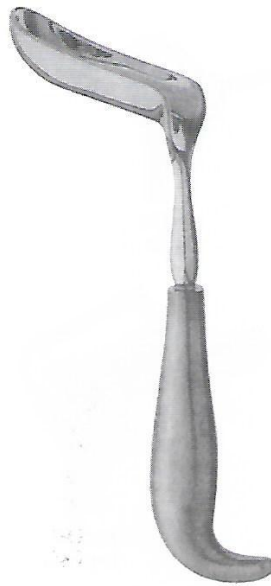

Ferguson-Moon Rectal Retractors

F8-402

Blade 60 mm x 24 mm wide
23 cm 9"

F8-403

Blade 75 mm x 35 mm wide
25 cm 10"



Hill Ferguson Rectal Retractors

F8-404

Blade 64 mm x 24 mm wide
23 cm 9"

F8-405

Blade 76 mm x 32 mm wide
23 cm 9"

F8-406

Blade 76 mm x 35 mm wide
25 cm 10"



Kelly Retractors

F8-407 24 cm 9 1/2"
50 x 40 mm wide

F8-408 24 cm 9 1/2"
65 x 50 mm wide

F8-409 25 cm 10"
75 x 65 mm wide

F8-410 25 cm 10"
90 x 75 mm wide



Richardson Retractors



F8-411 24 cm 9 1/2"
Blade 25 x 20 mm wide

F8-412 24 cm 9 1/2"
Blade 36 x 28 mm wide

F8-413 24 cm 9 1/2"
Blade 44 x 28 mm wide

F8-414 25 cm 10"
Blade 52 x 22 mm wide

F8-415 25 cm 10"
Blade 70 x 52 mm wide

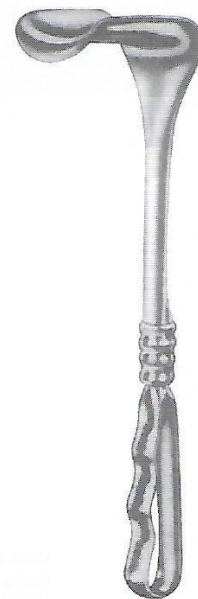

Kelly Retractor F8-416 25 cm, 10" 55 x 50 mm

RETRACTORS



Wundhaken | Ecarteurs
 Separadores | Divaricatori



Richardson-Eastman Retractor
 25.0 cm 10", Set of 2 piece



Richardson Retractor
 24.0 cm 9.5"



Richardson Retractor
F8-422
 24.0 cm 9.5"



RETRACTORS

Wundhaken
Separadores

Ecarteurs
Divaricatori

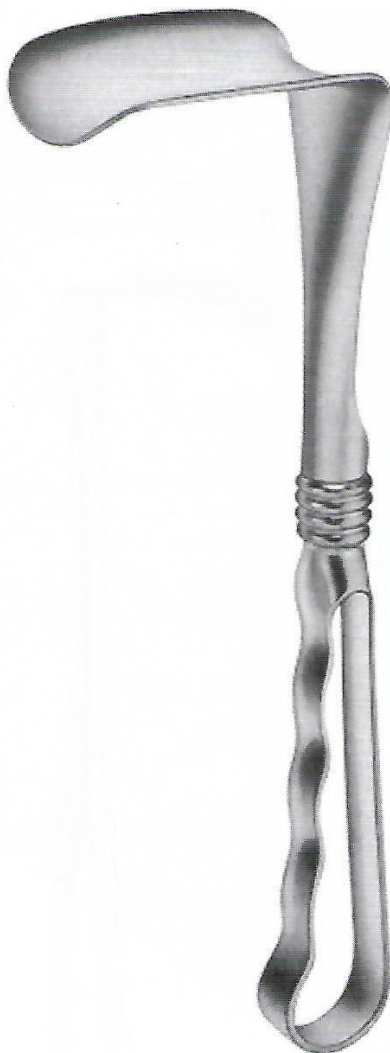
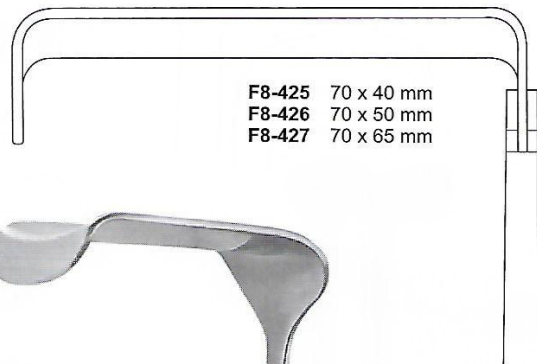
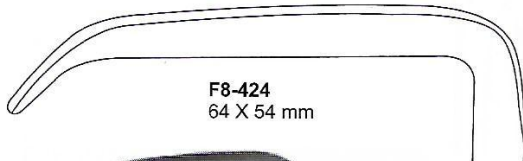

Kelly Retractor
26.0 cm 10 1/4"



Morris Retractor
24.5 cm 9 3/4"

RETRACTORS



Wundhaken | Ecarteurs
 Separadores | Divaricatori

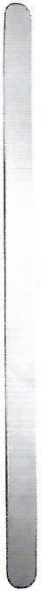

Item	Description	Tip
F8-428	20 cm, 8"	12 mm
F8-429	20 cm, 8"	17 mm
F8-430	20 cm, 8"	25 mm
F8-431	33 cm, 13"	25 mm
F8-432	33 cm, 13"	32 mm
F8-433	33 cm, 13"	40 mm
F8-434	33 cm, 13"	50 mm

Malleable Retractor



**Ribbon Retractor
F8-435**
20 cm, 8"
Width 4 cm



**Ribbon Retractor
F8-436**
20 cm, 8"
Width 2.5 cm



Tuffier / Haberer Retractor
F8-437 20 cm, 8" 17 x 25 mm
F8-438 28 cm, 11" 25 x 30 mm
F8-439 30 cm, 11 ¼" 37 x 45 mm
 malleable



**Bruening Spatula
F8-439A**
19 cm



Flexival Abdominal Spatula

- F8-439B 300x20mm
- F8-439C 300x25mm
- F8-439D 300x30mm
- F8-439E 300x35mm
- F8-439F 300x40mm
- F8-439G 300x45mm
- F8-439H 300x50mm



**Reverdin Retractor
F8-440** 28 cm, 11"
46 x 60 mm



**Reverdin Retractor
F8-441** 29 cm, 11 ½"

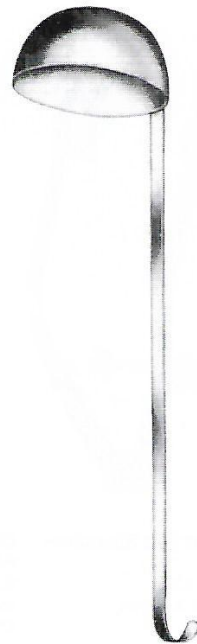

**Blood Scoop
F8-442** 15 cm, 6"



RETRACTORS

Wundhaken
Separadores

Ecarteurs
Divaricatori

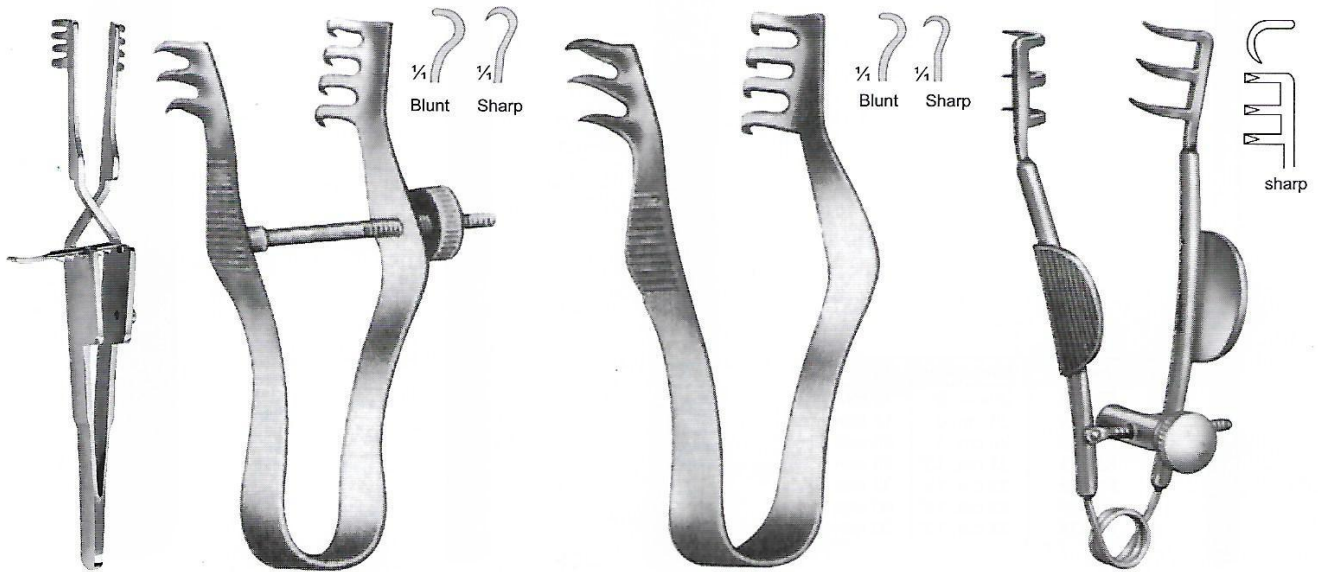

Heiss Retractor
F8-443 10 cm, 4"
Sharp 4:4
F8-444 10 cm, 4"
Blunt 4:4

Finsen Retractor
F8-445 7 cm, 2 3/4"
3 x 4 teeth, sharp
F8-446 7 cm, 2 3/4"
3 x 4 teeth, Blunt

Finsen Retractor
F8-447 5 cm, 2"
2 x 3 teeth sharp/blunt
F8-448 7 cm, 2 3/4"
2 x 3 teeth sharp/blunt

Buckley Retractor
F8-449
6 cm, 2 1/2"



Lancaster Eye Speculum
F8-450
8.3 cm 3 1/4",
blades 15 X 5 mm

Castroviejo Eye Speculum
F8-451
9.5 cm 3 3/4",
medium blades
15 X 5 mm O.D.

Wire Retaining Retractor
F8-452 8.5 cm, 3 1/2" 3 x 3 Prong
F8-453 8.5 cm, 3 1/2" 1 x 1 Prong Sharp

Farr Wire Retractor
F8-454 14 cm 5 1/2"
prongs 1.9 cm 3/4"

ALM Retractor
F8-455 7 cm, 2 3/4"
4 x 4 teeth sharp/blunt
F8-456 10 cm, 4"
4 x 4 teeth sharp/blunt

RETRACTORS

Wundhaken
Separadores

Ecarteurs
Divaricatori



Jansen Retractor
F8-457 10 cm, 4"
Sharp 3x3
F8-458 10 cm, 4"
Blunt 3x3



Houzel Retractor
F8-459 29 cm, 11 1/2"



Mollison Retractor
F8-460 15 cm, 6"
sharp



Markham/Meyerding Retractor
F8-461 18 cm, 7" Blade 55 x 25 mm Left
F8-462 18 cm, 7" Blade 55 x 25 mm Right



Milligan Retractor
F8-463 13 cm, 5"
18.5 mm x 20 mm
Blunt, 3x3



Darling Retractor
F8-464 18 cm, 7"
40 x 76/25 x 54 mm
F8-465 18 cm, 7"
25 x 64/40 x 76 mm
Laminectomy Retractors
1 blade toothed



RETRACTORS

Wundhaken | Ecarteurs
Separadores | Divaricatori



Debakey Gelpi Retractor
F8-466 13.5cm 5 3/8"
Spread 3 1/8" 8cm, Sharp,



Gelpi-Loktite Retractor

F8-467 9 cm, 3 1/2"
6 mm Sharp
F8-468 11 cm, 4 1/4"
10 mm Sharp
F8-469 14 cm, 5 1/2"
10 mm Sharp
F8-470 16 cm, 6 1/2"
10 mm Sharp
F8-471 19 cm, 7 1/2"
10 mm Sharp



Gelpi-Perineal Retractor
F8-472 17.8 cm, 7"
ball stops on sharp tenaculum prongs,
arm length 4-3/4" 12.1cm



Gelpi-Loktite Retractor
F8-473 9 cm, 3 1/2" 6 mm Sharp CROSS OVER
F8-474 11 cm, 4 1/4" 10 mm Sharp CROSS OVER
F8-475 14 cm, 5 1/2" 10 mm Sharp CROSS OVER
F8-476 16 cm, 6 1/2" 10 mm Sharp CROSS OVER
F8-477 19 cm, 7 1/2" 10 mm Sharp CROSS OVER



Seletz-Gelpi Retractor
F8-478 17.8cm, 7"
modified with long
curve in shanks



Schuhknecht Retractor
F8-479 Sharp
F8-480 Blunt
14 cm, 5 1/2"

RETRACTORS



Wundhaken | Ecarteurs
 Separadores | Divaricatori



Wullstein Retractor
 F8-481 F8-484 10.5 cm, 4"
 F8-482 F8-485 13.0 cm, 5"
 F8-483 F8-486 16.0 cm, 6 1/4"
 Sharp Blunt



Travers Retractor
 F8-487
 21 cm, 8 1/4" Blunt



Rigby Retractor
 F8-488 35 x 20 mm
 F8-489 60 x 20 mm
 F8-490 65 x 15 mm
 18 cm, 7"



Weitlaner Retractor
 F8-491
 13.0 cm 5.25"
 Sharp

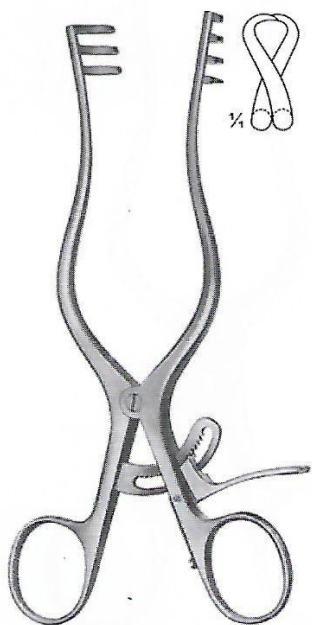

Weitlaner Retractor
 F8-492
 16.5 cm 6.5"
 Sharp



Plester Retractor
 F8-493
 11.0 cm 4.25"
 Blunt

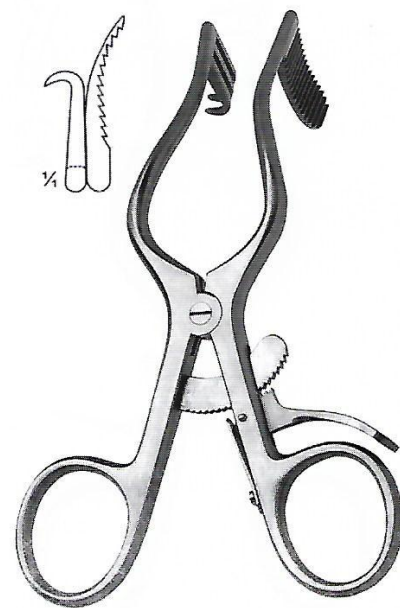

Perkins Retractor
 F8-494
 13.0 cm 5.25"



RETRACTORS

Wundhaken
Separadores

Ecarteurs
Divaricatori

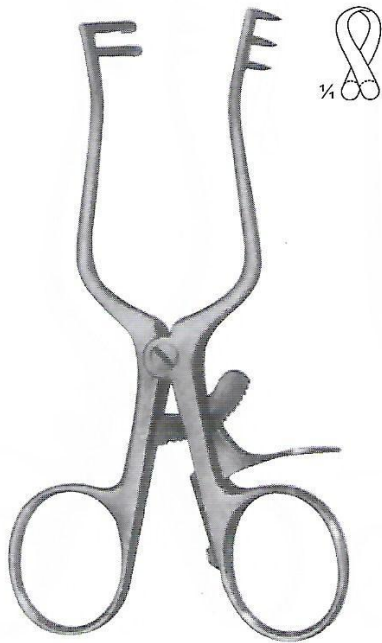

**Weitlaner Retractor
F8-495**
11.0 cm
Sharp



**Weitlaner Retractor
F8-496**
11.0 cm
Semi-Sharp



**Weitlaner Retractor
F8-497**
11.0 cm
Blunt



**Weitlaner Retractor
F8-498**
13.0 cm
Sharp



**Weitlaner Retractor
F8-499**
13.0 cm
Semi-Sharp



**Weitlaner Retractor
F8-500**
13.0 cm
Blunt

RETRACTORS



Wundhaken
Separadores

Ecarteurs
Divaricatori



Kolbel Soft Tissue Retractor
F8-501 18.0cm 7"
Angled, 2 x 2 Pronged



Meyerding Retractor
F8-502 16.5cm 6 1/2"
F8-503 24.1cm 9 1/2" Large Blade
8.9 cm 3 1/2" X 5.1 cm 2"
F8-504 24.1 cm 9 1/2" Small Blade
5.1 cm 2" X 1.6 cm 5/8"



D'Errico-Adson Retractor
F8-505 19.0cm 7 3/8"
4 X 4-pronged,
2.0cm 3/4" depth blade
Sharp

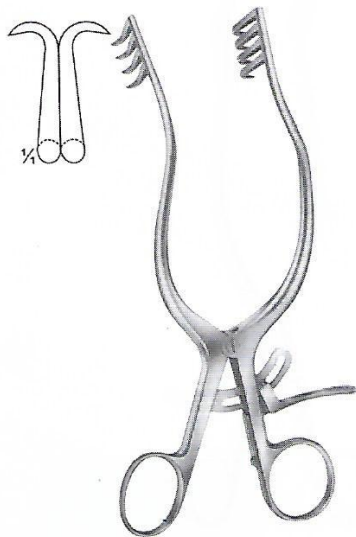

Anderson-Adson Retractor
F8-506 19.0 cm 7 1/2"
Sharp

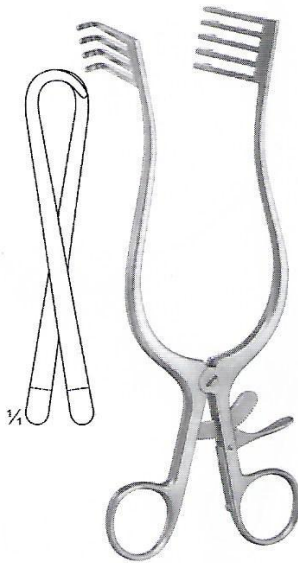

Norfolk & Norwich Retractor
F8-507 22.0 cm 8 3/4"
Blunt



Adson Retractor
F8-508
19.1 cm 7-1/2" sharp,
4 X 4 teeth straight Arms

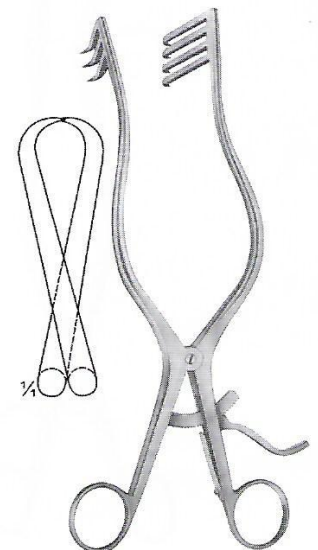

Adson Retractor
F8-509 26.5 cm 10 1/4"
Sharp



RETRACTORS

Wundhaken
Separadores

Ecarteurs
Divaricatori



Beckman-Weitlaner Retractor
F8-510
16.5cm 6 1/2"
3 x 4 Sharp prongs



Beckman-Weitlaner Retractor
F8-511
16.5cm 6 1/2"
3 x 4 Blunt prongs

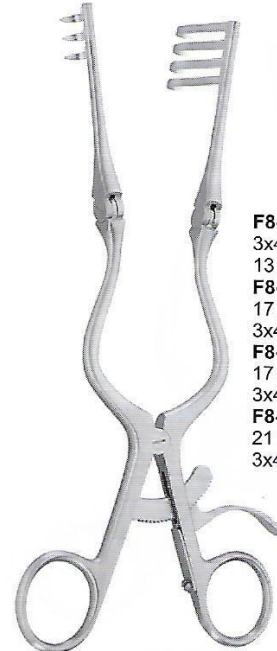

Cone Retractor

F8-512 31 cm, 12"
3x4 Blunt prongs,
13 mm x 14.5 mm
F8-513 16.5 cm, 6 1/2"
17 mm x 19 mm
3x4 Sharp prongs,
F8-514 16.5 cm, 6 1/2"
17 mm x 19 mm
3x4 Blunt prongs,
F8-515 20 cm, 8"
21 mm x 210 mm
3x4 Blunt prongs,



Beckman Retractor
F8-516 31.7cm 12 1/2"
Spread 3.5cm 5 3/8" 4 x 4
Sharp prongs, Arm length
8.5cm 3 3/8"



Beckman Retractor
F8-517 31.1cm 12 1/4"
4 x 4 Sharp prongs 27mm,
Side Blade 1.7cm 5/8" deep,



Beckman Retractor
F8-518 31.1cm 12 1/4"
4 x 4 Blunt prongs 27mm,
Side Blade 1.7cm 5/8" deep,

RETRACTORS



Wundhaken | Ecarteurs
 Separadores | Divaricatori



Joll (Friedman)
F8-519 15.5 cm, 6 1/2"
 Thyroid- and Vaginal Retractor



Jackson Burrows Retractor
F8-520 18.5 cm, 7"
 Blunt

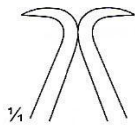

Gelpi Vaginal Retractor
F8-521 13.5 cm, 5"

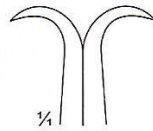

Gelpi Skin & Vaginal Retractor
F8-522 17.5 cm, 7"

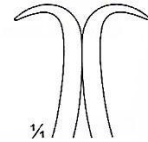

De Bakey Femur Retractor
F8-523 14.5 cm, 4 1/2"



RETRACTORS

Wundhaken
Separadores

Ecarteurs
Divaricatori

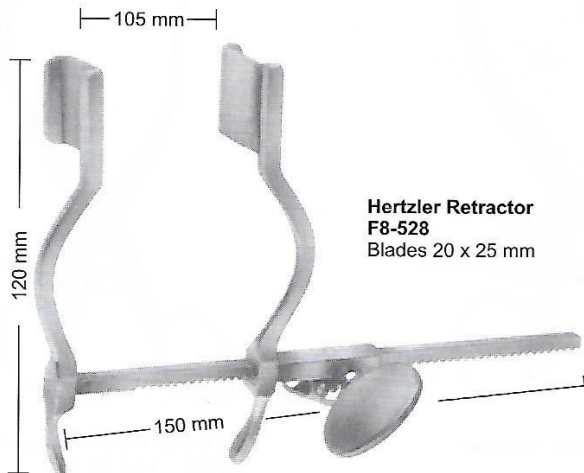
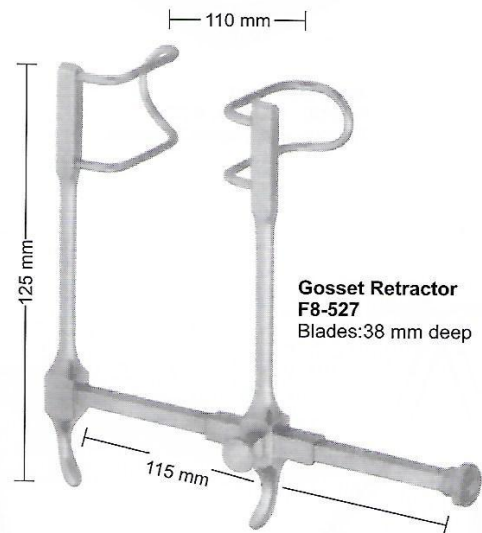
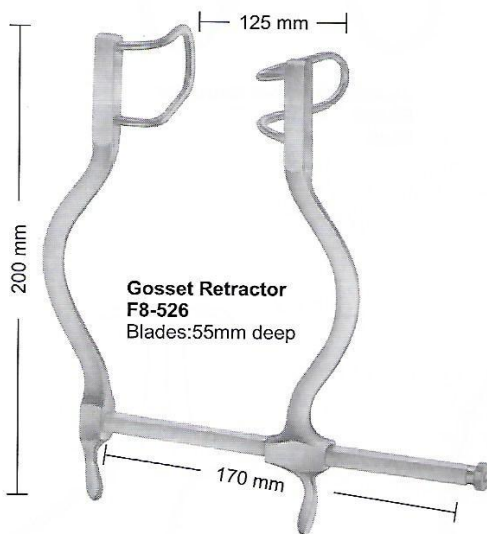
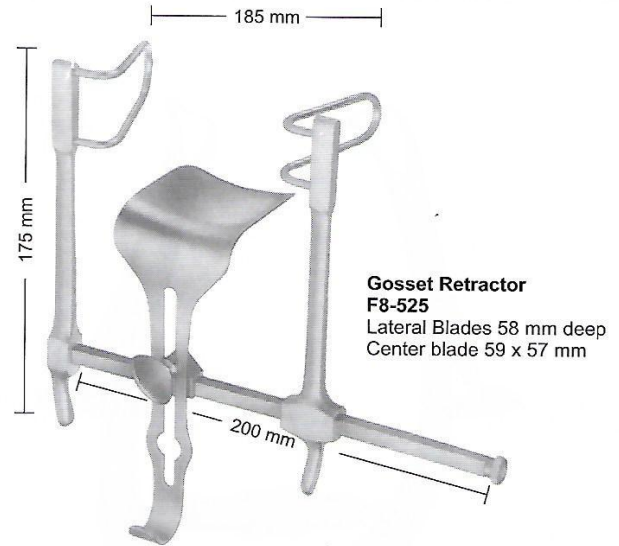

RETRACTORS

Wundhaken | Ecarteurs
 Separadores | Divaricatori

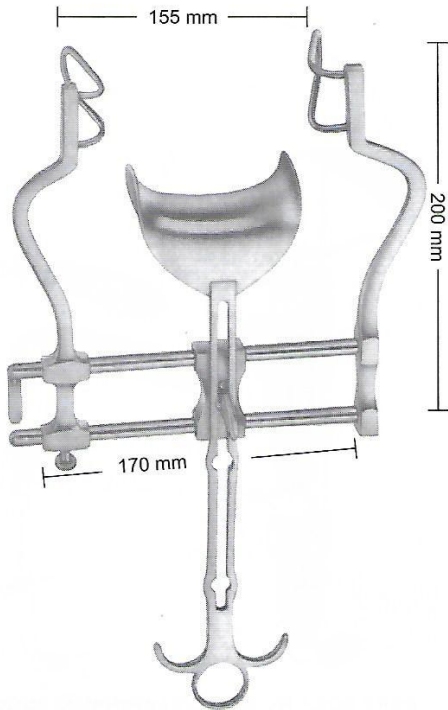

**Balfour Retractor
 F8-530**
 Lateral blades 60 mm deep
 Center blade 47 x 80 mm



**Balfour Retractor
 F8-531**
 Lateral blades 105 mm deep
 Center blade 107 x 59 mm

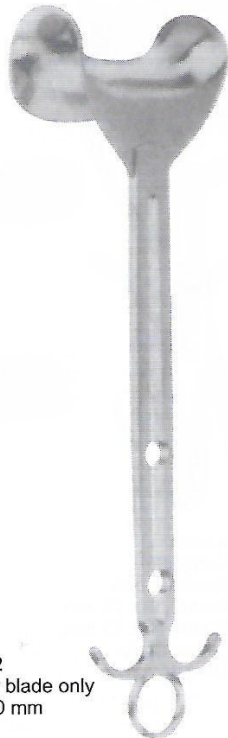

F8-532
 Center blade only
 54 x 80 mm

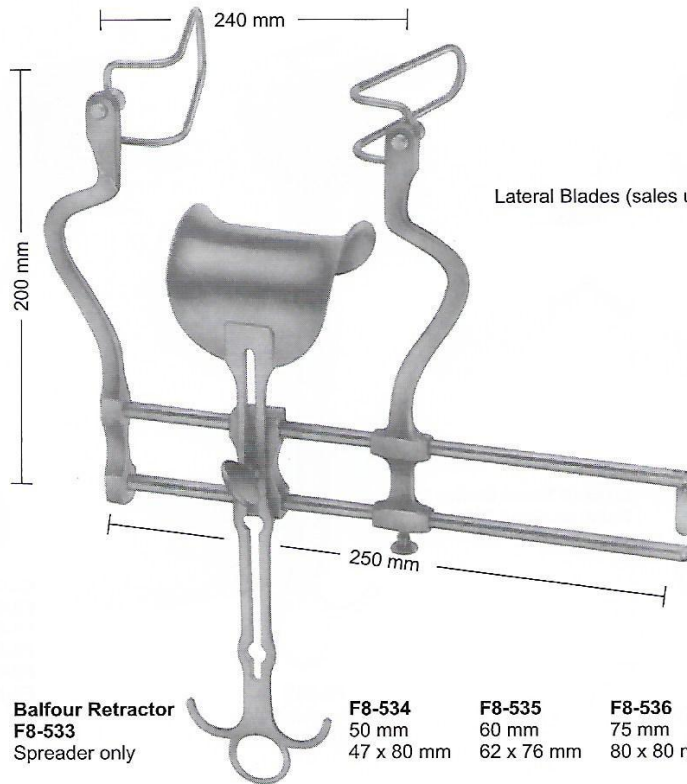

**Balfour Retractor
 F8-533**
 Spreader only

Lateral Blades (sales unit of blades in pairs)

- | | | | |
|--------------------------------------|--------------------------------------|--------------------------------------|--------------------------------------|
| F8-534
50 mm
47 x 80 mm | F8-535
60 mm
62 x 76 mm | F8-536
75 mm
80 x 80 mm | F8-537
90 mm
80 x 80 mm |
|--------------------------------------|--------------------------------------|--------------------------------------|--------------------------------------|



RETRACTORS

Wundhaken
Separadores

Ecarteurs
Divaricatori



O'Sullivan/O'Connor Retractor
F8-538 (Set includes frame & 3 blades)
F8-539 Frame Only (not pictured)



F8-540
Single Retractor Blade
110 x 70 mm

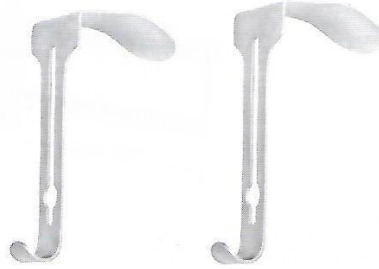

F8-541
Set of 2 Retractor Blade
80 x 45 mm



ABRE BOCA MC IVOR C/3 LAMINAS S/ SUCCAO
ABRE BOCA
F8-541A

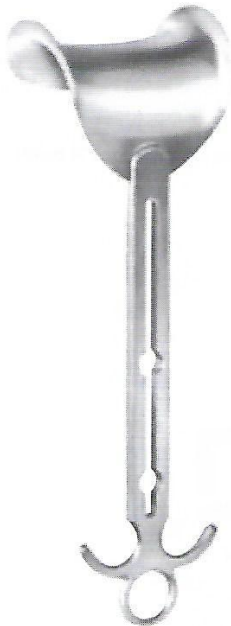

F8-542
Center Blade
45 x 80 mm
70 x 85 mm

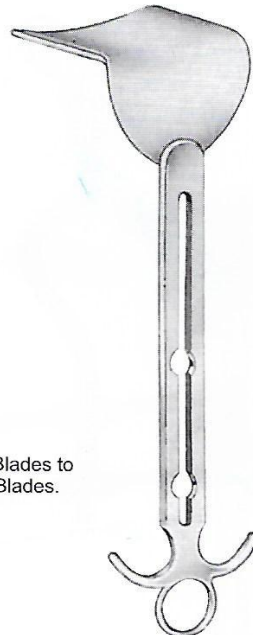

F8-543
Center Blade
100 x 60 mm

Sizes of These Blades to Same as about Blades.

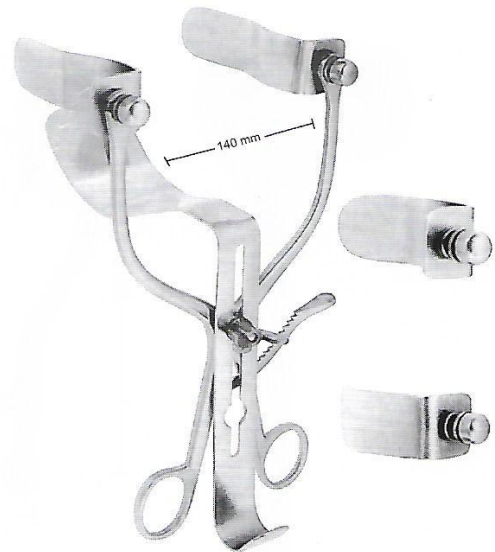

Collin Retractor
F8-544 Complete
F8-545 Spreader only
F8-546 Blades 55 x 25 mm
F8-547 Blades 80 x 25 mm
F8-548 Center Blade
115 x 45 mm

RETRACTORS

Wundhaken
Separadores

Ecarteurs
Divaricatori



Scoville-Richter Retractor
F8-549 Complete with 1 pair blades.
F8-550 Frame only.
 The Retractor bar and shanks may be easily rotated 180° when blades are in situ.

F8-553
62 x 52 mm

F8-554
62 x 37 mm

F8-555
47 x 51 mm

F8-556
30 x 40 mm

F8-557
37 x 62 mm



Initial Incision Retractor
F8-558 30cm 11 3/4"
 Complete



RETRACTORS

Wundhaken | Ecarteurs
Separadores | Divaricatori



Collin Retractor
F8-559 20 cm, 8"
complete with 2 lateral
blades and central blade



Legueu Retractor
F8-560
17 cm, 6 3/4"



Doyen Retractor
F8-561 48 mm x 90 mm
F8-562 48 mm x 105 mm
F8-563 48 mm x 120 mm
F8-564 48 mm x 135 mm
28 cm, 11"

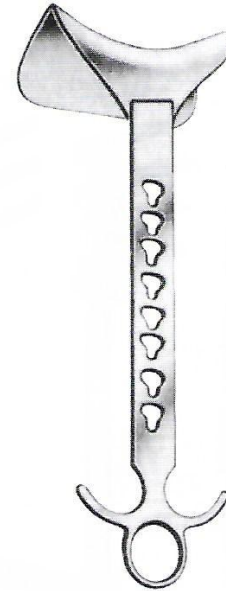

Rochard Retractor
F8-565 48 mm x 90 mm
F8-566 48 mm x 105 mm
F8-567 48 mm x 120 mm
F8-568 48 mm x 135 mm
F8-569 48 mm x 155 mm
31 cm, 12"

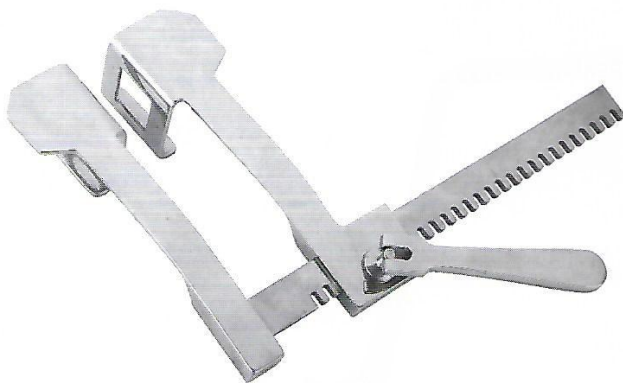

Finochietto Retractors
F8-569A 18x22 8cm
F8-569B 25x40 13cm
F8-569C 38x45 16cm
F8-569D 40x45 18cm

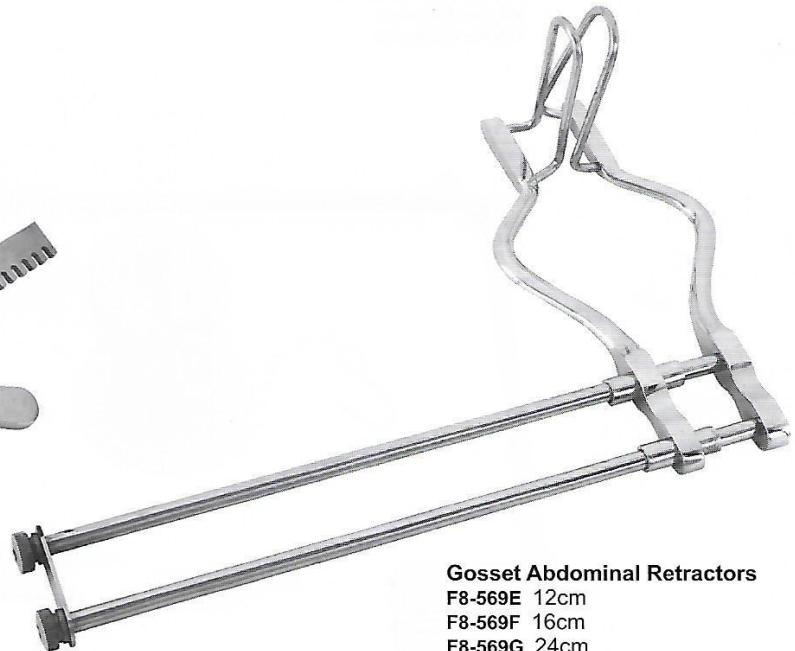

Gosset Abdominal Retractors
F8-569E 12cm
F8-569F 16cm
F8-569G 24cm
F8-569H 30cm

RETRACTORS



Wundhaken | Ecarteurs
 Separadores | Divaricatori

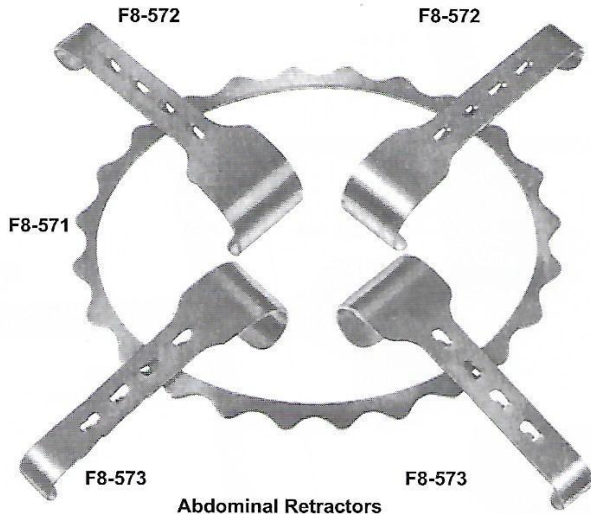

Abdominal Retractors
 for new-born and children

Denis-Browne Retractor

F8-570 Complete with 4 blades

F8-571 Frame 190 x 160 mm

F8-572 2 blades only 40 x 30 mm

F8-573 2 blades only 40 x 40 mm

F8-574
 Blades only 20 x 30 mm



F8-575
 Blades only 20 x 40 mm



Abdominal Retractors
 well suitable for gynaecologists

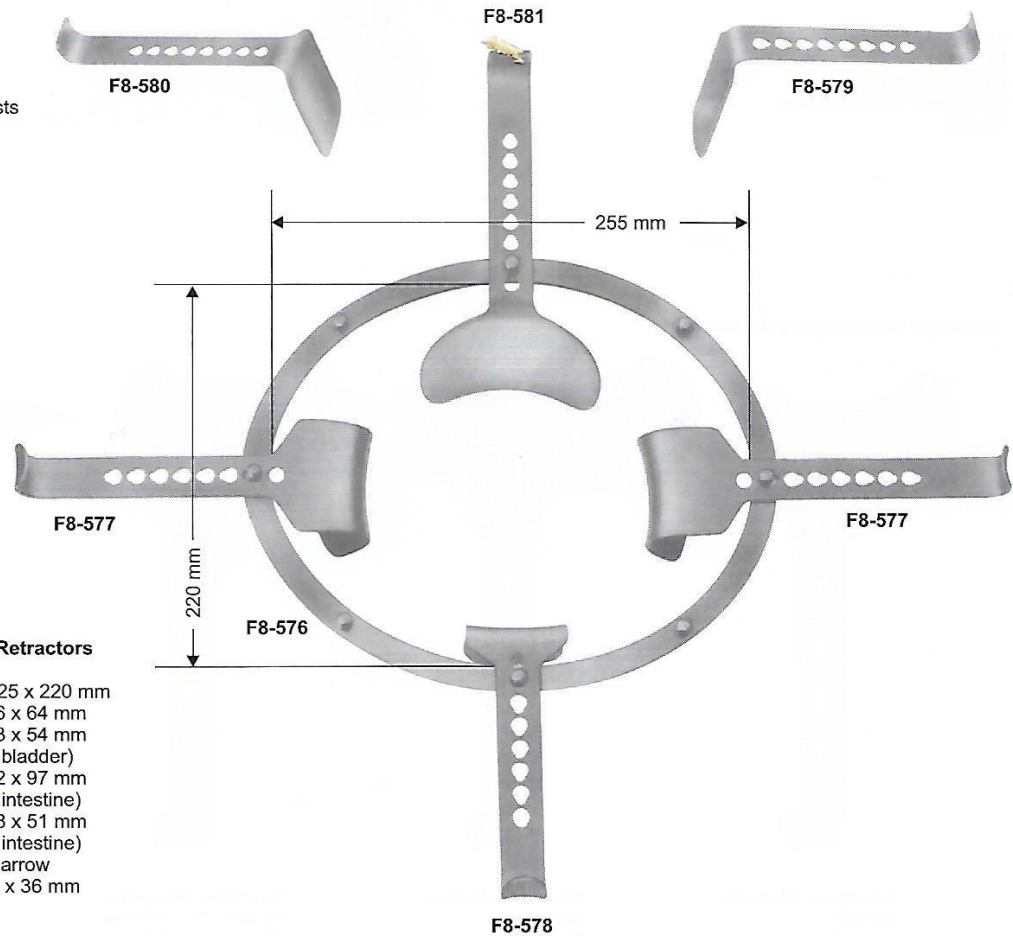

Semm Abdominal Retractors
 consisting of:

- F8-576** 1 frame 225 x 220 mm
- F8-577** 2 blade 46 x 64 mm
- F8-578** 1 blade 53 x 54 mm
 (for bladder)
- F8-579** 1 blade 82 x 97 mm
 (for intestine)
- F8-580** 1 blade 98 x 51 mm
 (for intestine)
- F8-581** 1 blade, narrow
 107 x 36 mm



RETRACTORS

Wundhaken | Ecarteurs
Separadores | Divaricatori

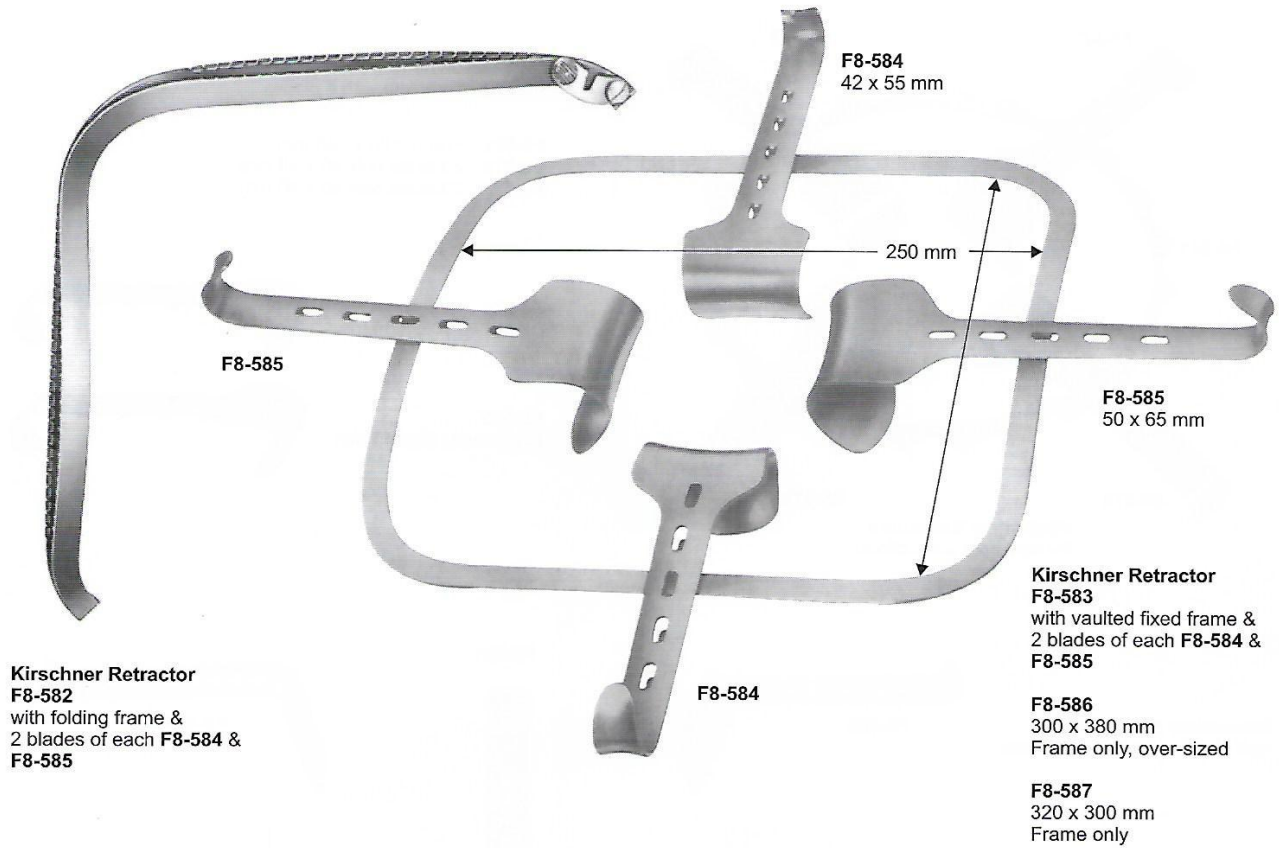

Additional valves for corpulent persons



Kirschner Retractor
F8-588
64 x 80 mm

**Kirschner-Balfour
Retractor**
F8-589
80 x 82 mm

Kirschner Retractor
F8-590 90 x 69 mm
F8-591 92 x 95 mm
F8-592 78 x 58 mm

Kirschner Retractor
F8-593 108 x 42 mm
F8-594 91 x 55 mm
F8-595 121 x 55 mm

BONE SURGERY INSTRUMENTS

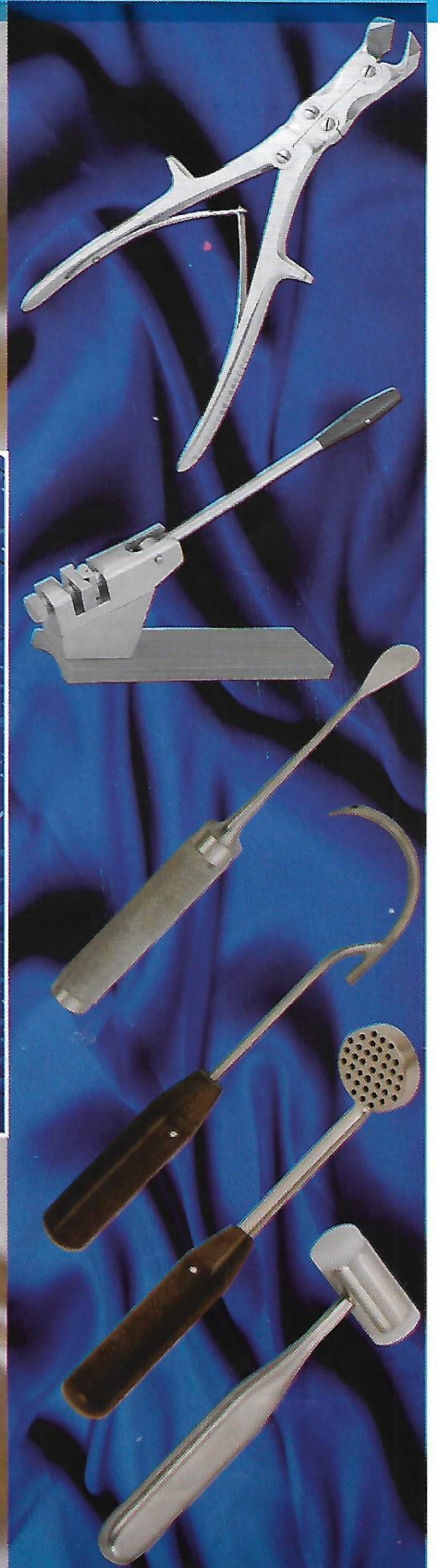
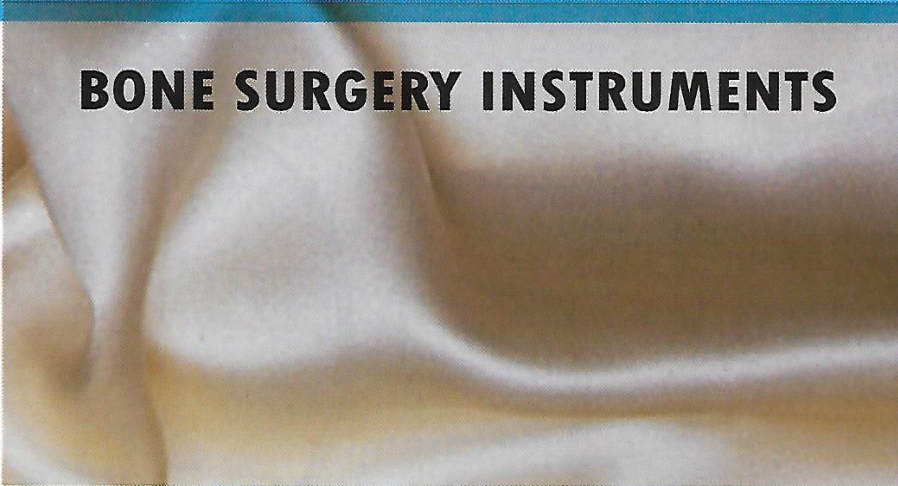



AMPUTATING & RESECTION SAWS

amputations-und resektiosagen
Scies a amputation et resection

sierra para amputacion y reseccion
seghe per amputazione

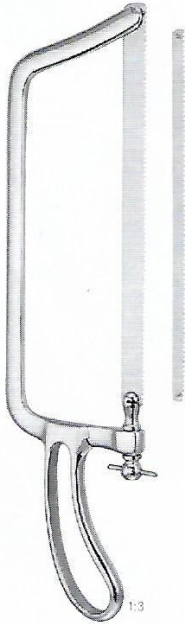

Charriere Saw
F9-001 35cm 13 3/4"
Spare saw blades
F9-002 12mm
F9-003 15mm



Charriere Bone Saw Complete
F9-004 35.5cm 14"
Straight tip, Straight shaft



Helferich-Bier Saw
F9-005 39cm 15 1/2"
Spare saw blades
F9-006 3mm
F9-007 5mm
F9-008 5mm

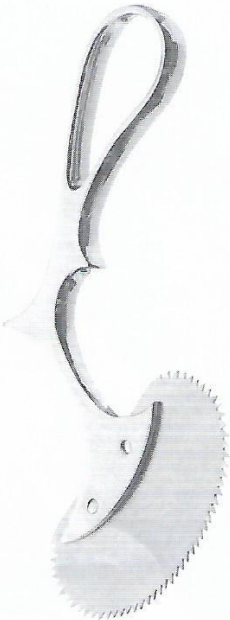

Engel Plaster Saw
F9-009 15.5 cm, 6"

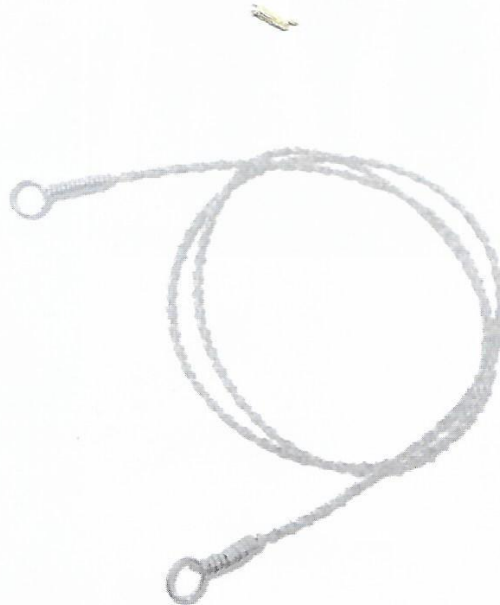

Serra Gigli
F9-009A 30 cm
F9-009B 40 cm
F9-009C 50 cm



Percy Amputation Shield
F9-010
30.5cm 12"
Handles Detachable,
Simple Pattern

RASPS, FILES



Raspeln, Feilen
Rapes, Limes

Escofinas, limas
Raspe, lime

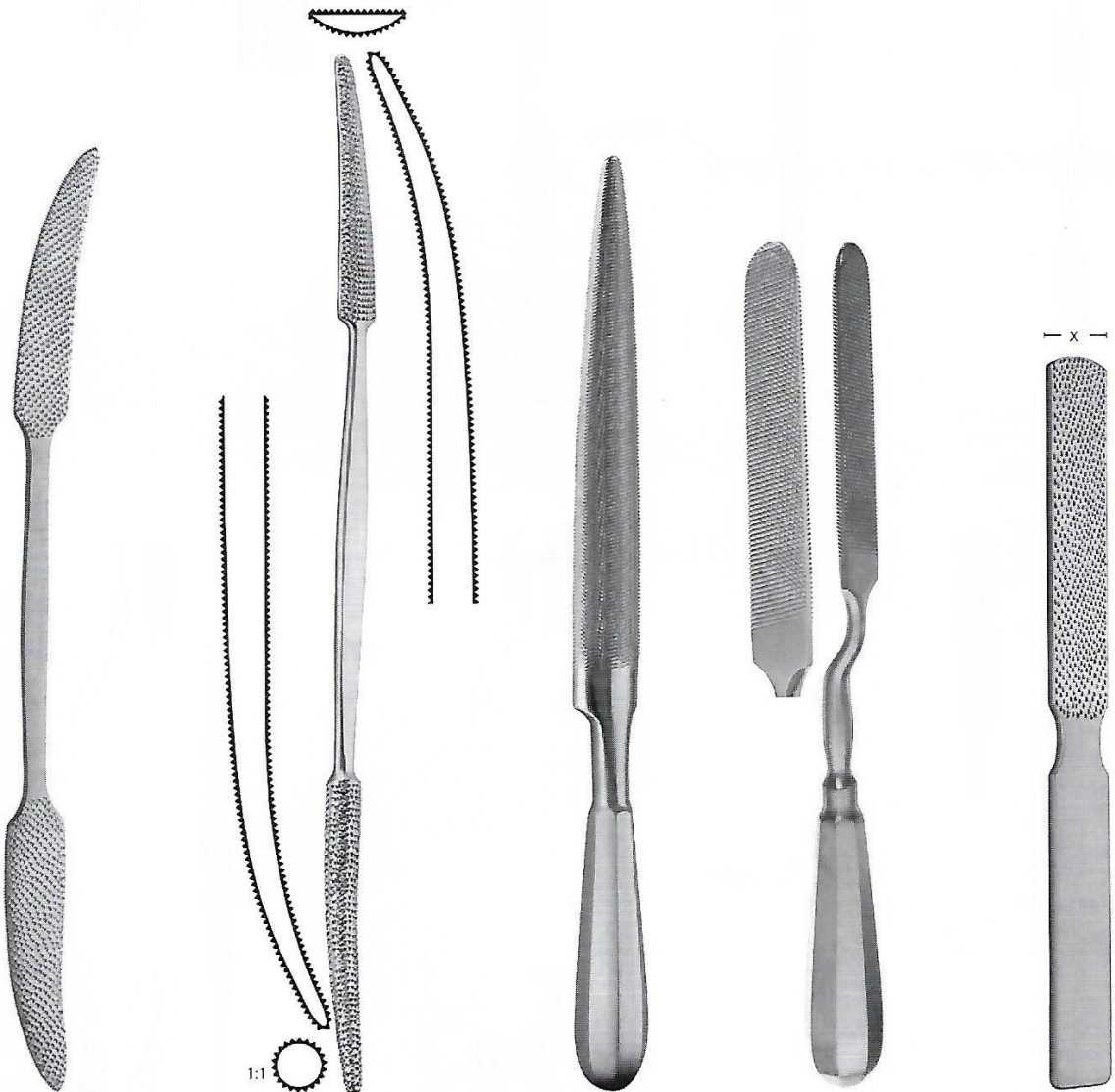

**Putti Bone Rasp
F9-011**
27.0 cm 10 3/4"
Double ended, One end curved up
one end curved sideways

**Putti Rasp
F9-012**
30.0 cm 12"
Double Ended

**Putti Bone File
F9-013**
28.0 cm 11"
semicircular

**Putti Bone File
Bayonet Shape
F9-014**
24.5 cm 9 3/4"
X=13 mm
semicircular

**Putti Bone File
F9-015**
22.0 cm 8 3/4"
X=20 mm
flat



BONE FILES

Knochenfeilen
Limas para huesos

Limes à os
Lime per ossa



**Foman Rasp
F9-016** 21.5cm 8 1/2"
Double ended, Fine & coarse serrations
4-sided convex and flat blades



**Foman Rasp
F9-017**
21 cm, 8 1/2"



Miller-Colburn Bone File
18 cm, 7"



Fig. 1
F9-018

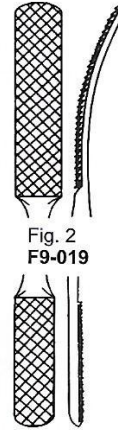

Fig. 2
F9-019

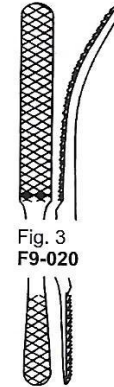

Fig. 3
F9-020

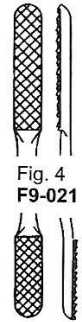
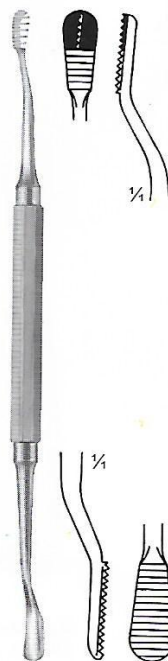

Fig. 4
F9-021

cross cut



**Kleinert-Kutz Bone Rasp
F9-022** 22.5cm 8 7/8"
Double ended,
Fine & coarse serrations



**Miller Alveotomy File
F9-023**
19 cm, 7 1/2"



**Miller Alveotomy File
F9-024**
19 cm, 7 1/2"

MALLETS



Hammer
Maillets

Martillos
Martelli



Doyen Mallets
25cm 7 3/4"
F9-025 25mmØ - 120g
F9-026 30mmØ - 180g
F9-027 35mmØ - 260g



Collin Mallets
F9-028 20cm 8"
30mmØ - 220g



Hajek Mallets
F9-029 21.5cm 8 1/2"
27mmØ - 140g

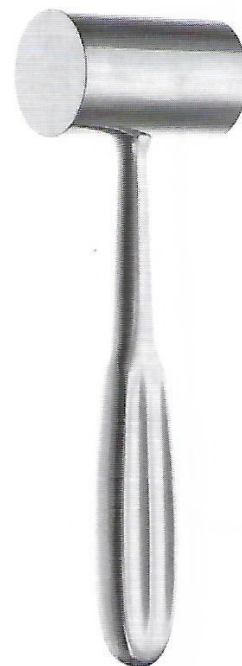

Kirk Mallets
F9-030 19cm 7 1/2"
38mmØ - 750g
F9-031 20.4cm 8"
Head diameter 38.0mm,
Weight: 1 lb. 4 oz.
570 grams



Partsch Mallets
F9-032 18cm 7"
22mmØ - 200g



Lucae Mallets
F9-033 19mmØ - 220g
F9-034 25mmØ - 260g
19cm 7 1/2"



Mallet Mallets
F9-035 19cm 7 1/2"
250mmØ - 205g
Solid steel, with
plastic faces

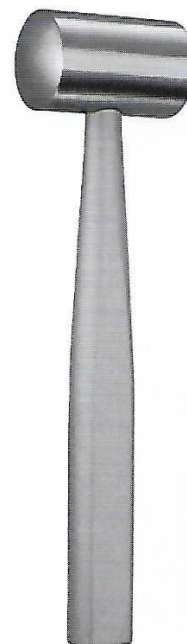

Cottle Mallets
F9-036 18.5cm 7 1/4"
30mmØ - 240g
1 side flat /
1 side convex



MALLETS

Hammer
Maillets

Martillos
Martelli



Solid Copper Head Mallet
F9-037 16.5cm 6 1/2"
Solid, Head diameter
20mm 3/4"



Nylon Head Mallet
F9-038 19.0cm 7 1/2"
Head diameter 25.4mm,
7.76 oz.
F9-039 19.5cm 7 5/8"
Head diameter 3cm 1 1/4"
Weight 11 oz.



**Extra 1 1/4" Nylon Face
FOR F9-039
F9-040 Head diameter
3cm 1 1/4"**

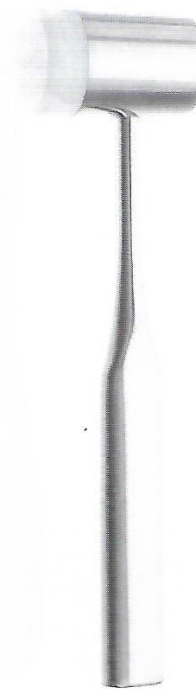

Combination Mallet
F9-041 19.5cm 7 5/8"
Solid, Head diameter 32.0mm,
Weight 12 oz 340 grams,
Head weight: 8 oz 227 grams



Bergmann Mallets
F9-042
24.5cm 9 3/4"
45mmØ - 300g



Ombredanne Mallets
F9-043
24cm 9 1/2"
40mmØ - 550g



Heath Mallets
F9-044 18cm 7"
40mmØ - 700g
F9-045 20cm 8"
45mmØ - 1000g



Williger Mallets
F9-046 28mmØ - 340g
F9-047 30mmØ - 400g
24cm 9 1/2"
Lead filled



Hajek Hammer
F9-047A 250gm
F9-047B 500gm



Universal Hammer
F9-047C 500gm
F9-047D 750gm

MALLETS



Hammer
Maillets

Martillos
Martelli

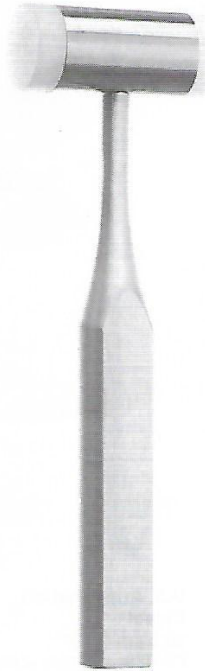

Mallet, Lightweight
F9-048 19.0cm 7 1/2"
Stainless Steel and Aluminum
Head diameter 25.0mm
Weight 7 oz 200 grams
Head Weight: 4 oz 113 grams

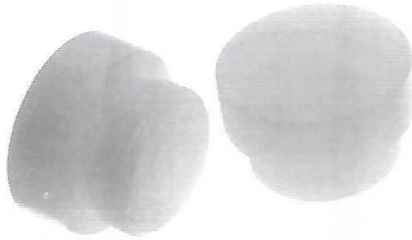

Nylon Caps Left & Right
FOR F9-048 (PAIR)
F9-049
1" (2.5cm)



Mallet #49
F9-050 19.5cm 7 3/4"
Head diameter 22.0mm
Weight 7 oz 200 grams
Head Weight: 5oz/150 grams



Mead Mallet
F9-051 19.0cm 7 1/2"
Head diameter 26.0mm
Weight 11 oz 315 grams
Head Weight: 6 oz 170 grams

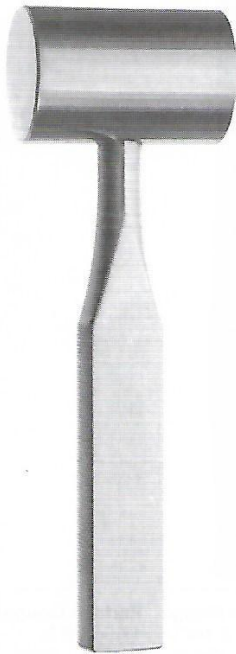

Heath Mallet, Heavyweight
F9-052 19.0cm 7 1/2"
Head diameter 40.0mm
Weight 2 lbs. (907 grams)
Head Weight: 20 oz (567 grams)

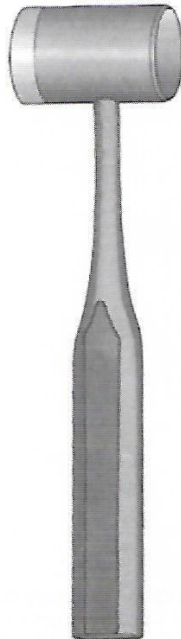

Orthopedic Mallet
F9-053 27.5cm 10 3/4"
Lightweight
Solid, Head diameter 35.0mm
Weight 2 lbs. (907 grams)
Head Weight: 1 lb. (454 grams)



Orthopedic Mallet
F9-054 28.0cm 11"
Heavyweight
Solid, Head diameter 50.0mm
Head Weight: 2 lb. (900 grams)

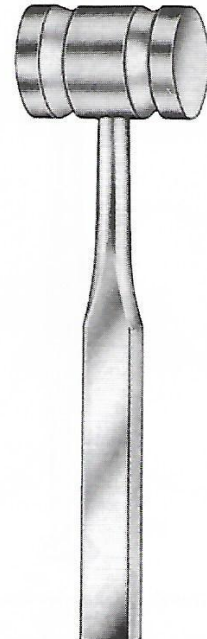

Ortho Mallets
F9-055 26.5 cm 10 1/2"
(450g)



BONE CHISELS & GOUGES

*Knochenmeißel
Ciseaux-burins, gouges*

*Cineles, gubias
Scalpelli, sgorbi*



Osteotome
13.5cm 5 1/4"
F9-056 8mm
F9-057 10mm
F9-058 12mm
F9-059 14mm
F9-060 16mm



Chisel
13.5cm 5 1/4"
F9-061 8mm
F9-062 10mm
F9-063 12mm
F9-064 14mm
F9-065 16mm



Gouge
13.5cm 5 1/4"
F9-066 8mm
F9-067 10mm
F9-068 12mm
F9-069 14mm
F9-070 16mm



Lucas Chisel
16cm 6 1/4"
F9-071 3mm
F9-072 4mm
F9-073 5mm
F9-074 6mm



Lucas Gouge
16cm 6 1/4"
F9-075 3mm
F9-076 4mm
F9-077 5mm
F9-078 6mm



**U.S. Army Pattern
Chisel**
16.5 cm 6 1/2"
F9-079 6 mm wide
F9-080 12 mm wide
F9-081 18 mm wide



Alexander Chisel
18cm 7"
F9-082 4mm
F9-083 6mm
F9-084 8mm
F9-085 10mm
F9-086 12mm
F9-087 14mm



Alexander Gouge
18cm 7"
F9-088 4mm
F9-089 6mm
F9-090 8mm
F9-091 10mm
F9-092 12mm
F9-093 14mm



Partsch Chisel
11.5cm 4 1/2"
F9-094 2mm
F9-095 3mm
F9-096 4mm
F9-097 6mm
F9-098 7mm
F9-099 8mm

Partsch Chisel
13.5cm 5 1/4"
F9-100 2mm
F9-101 3mm
F9-102 4mm
F9-103 6mm
F9-104 7mm
F9-105 8mm

Partsch Chisel
17.5cm 6 3/4"
F9-106 2mm
F9-107 3mm
F9-108 4mm
F9-109 6mm
F9-110 7mm
F9-111 8mm

Partsch Gouge
11.5cm 4 1/2"
F9-112 2mm
F9-113 3mm
F9-114 4mm
F9-115 6mm
F9-116 7mm
F9-117 8mm

Partsch Gouge
13.5cm 5 1/4"
F9-118 2mm
F9-119 3mm
F9-120 4mm
F9-121 6mm
F9-122 7mm
F9-123 8mm

Partsch Gouge
17.5cm 6 3/4"
F9-124 2mm
F9-125 3mm
F9-126 4mm
F9-127 6mm
F9-128 7mm
F9-129 8mm

BONE CHISELS & GOUGES



Knochenmeißel
Ciseaux-burins, gouges

Cineles, gubias
Scalpelli, sgorbi



- | | |
|----------|-------|
| Straight | |
| F9-130 | 09 mm |
| F9-131 | 14 mm |
| F9-132 | 19 mm |
| F9-133 | 25 mm |
| Curved | |
| F9-134 | 09 mm |
| F9-135 | 14 mm |
| F9-136 | 19 mm |
| F9-137 | 25 mm |

Smith Peterson Gouge
20 cm, 8"



- | | |
|----------|-------|
| Straight | |
| F9-138 | 06 mm |
| F9-139 | 09 mm |
| F9-140 | 13 mm |
| F9-141 | 16 mm |
| F9-142 | 19 mm |
| F9-143 | 25 mm |
| F9-144 | 32 mm |
| Curved | |
| F9-145 | 06 mm |
| F9-146 | 09 mm |
| F9-147 | 13 mm |
| F9-148 | 16 mm |
| F9-149 | 19 mm |
| F9-150 | 25 mm |
| F9-151 | 32 mm |

Smith Peterson Osteotome
20 cm, 8"



- | | |
|----------|-------|
| Straight | |
| F9-152 | 10 mm |
| F9-153 | 15 mm |
| F9-154 | 20 mm |
| F9-155 | 25 mm |
| Curved | |
| F9-156 | 10 mm |
| F9-157 | 15 mm |
| F9-158 | 20 mm |
| F9-159 | 25 mm |

Stille Gouge
20 cm, 8"



- | | |
|------------------|-------|
| Chisels | |
| F9-160 | 10 mm |
| F9-161 | 12 mm |
| F9-162 | 15 mm |
| F9-163 | 20 mm |
| F9-164 | 25 mm |
| Osteotome | |
| F9-165 | 10 mm |
| F9-166 | 12 mm |
| F9-167 | 15 mm |
| F9-168 | 20 mm |
| F9-169 | 25 mm |

Stille
20 cm, 8"

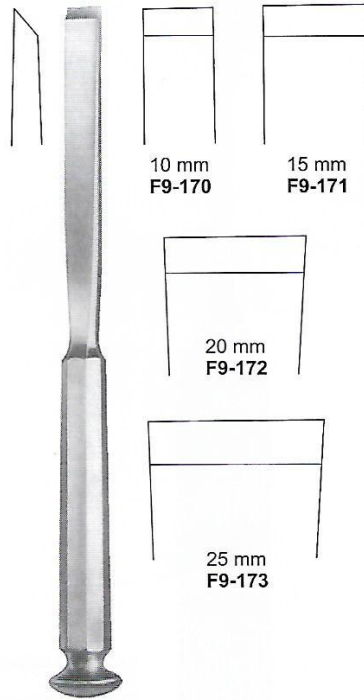

Stille Chisel
20 cm, 8"

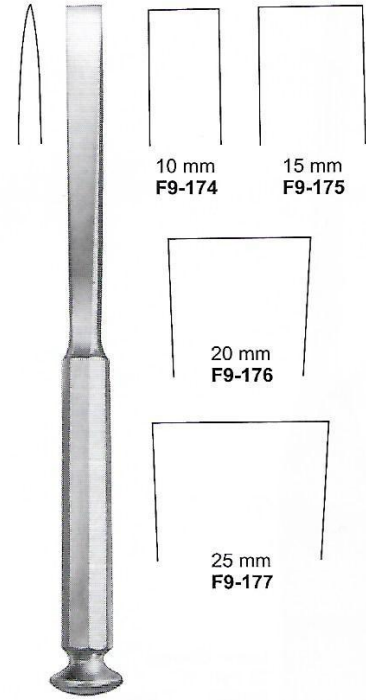

Stille Osteotome
20 cm, 8"



BONE CHISELS & GOUGES

Knochenmeißel

Ciseaux-burins, gouges

Cineles, gubias

Scalpelli, sgorbi



Lexer Osteotome

22 cm, 8 3/4"

- F9-178 7 mm
- F9-179 10 mm
- F9-180 12 mm
- F9-181 15 mm
- F9-182 20 mm
- F9-183 25 mm
- F9-184 30 mm

Lexer Modif. Osteotome

29 cm, 11 1/2"

- F9-185 7 mm
- F9-186 10 mm
- F9-187 12 mm
- F9-188 15 mm
- F9-189 20 mm
- F9-190 25 mm
- F9-191 30 mm



Lexer Modif. Chisel

29 cm, 11 1/2"

- F9-192 7 mm
- F9-193 10 mm
- F9-194 12 mm
- F9-195 15 mm
- F9-196 20 mm
- F9-197 25 mm
- F9-198 30 mm

Lexer Chisel

22 cm, 8 3/4"

- F9-199 7 mm
- F9-200 10 mm
- F9-201 12 mm
- F9-202 15 mm
- F9-203 20 mm
- F9-204 25 mm
- F9-205 30 mm



Lexer Gouge

25 mm, 10"

- F9-206 7 mm
- F9-207 10 mm
- F9-208 15 mm
- Straight



Lexer Gouge

25 mm, 10"

- F9-209 7 mm
- F9-210 10 mm
- F9-211 15 mm
- Curved



Lexer Osteotome Flat

22 cm, 8 3/4"

- F9-212 10 mm
- F9-213 15 mm
- F9-214 20 mm
- F9-215 25 mm



Lexer Gouge

Tuffnel Handle

- 22 cm, 8 3/4"
- F9-216 10 mm
- F9-217 15 mm
- F9-218 20 mm
- F9-219 25 mm

BONE CHISELS & GOUGES



Knochenmeißel
Ciseaux-burins, gouges

Cineles, gubias
Scalpelli, sgorbi



Mini Lexer Osteotome
F9-220
18 cm, 7"



Mini Lexer Chisel
F9-221
18 cm, 7"
Hollow



Capener Osteotome
With Tuffnel Handle
25cm 10"
F9-222 10mm
F9-223 12mm
F9-224 15mm
F9-225 20mm
F9-226 25mm
F9-227 30mm
Straight



Capener Osteotome
With Tuffnel Handle
25cm 10"
F9-228 10mm
F9-229 12mm
F9-230 15mm
F9-231 20mm
F9-232 25mm
F9-233 30mm
Curved



Capener Chisels
With Tuffnel Handle
25cm 10"
F9-234 6mm
F9-235 8mm
F9-236 10mm
F9-237 12mm
F9-238 15mm
F9-239 20mm
F9-240 25mm
F9-241 30mm
Straight



Capener Osteotome
With Tuffnel Handle
25cm 10"
F9-242 6mm
F9-243 8mm
F9-244 10mm
F9-245 12mm
F9-246 15mm
F9-247 20mm
F9-248 25mm
F9-249 30mm
Curved



BONE CHISELS & GOUGES

Knochenmeißel

Ciseaux-burins, gouges

Cineles, gubias

Scalpelli, sgorbi



Lambotte Osteotome

25cm 9 3/4"

- F9-250 6mm
- F9-251 8mm
- F9-252 10mm
- F9-253 13mm
- F9-254 15mm
- F9-255 20mm
- F9-256 25mm
- F9-257 30mm
- F9-258 38mm
- F9-259 44mm
- F9-260 50mm
- Straight



Lambotte Osteotome

25cm 9 3/4"

- F9-261 6mm
- F9-262 8mm
- F9-263 10mm
- F9-264 13mm
- F9-265 15mm
- F9-266 20mm
- F9-267 25mm
- F9-268 30mm
- F9-269 38mm
- F9-270 44mm
- F9-271 50mm
- Curved



Mini-Lambotte Osteotome

12.5cm 5"

- F9-272 3mm
- F9-273 4mm
- F9-274 6mm
- F9-275 8mm
- F9-276 10mm
- F9-277 12mm
- F9-278 15mm
- Straight



Mini-Lambotte Osteotome

17cm 6 3/4"

- F9-279 3mm
- F9-280 4mm
- F9-281 6mm
- F9-282 8mm
- F9-283 10mm
- F9-284 12mm
- F9-285 15mm
- Straight



Lambotte Osteotome

12.5cm, 5" Straight

- F9-286 2mm tip width
- F9-287 4mm tip width
- F9-288 6mm tip width
- F9-289 8mm tip width
- F9-290 10mm tip width
- F9-291 12mm tip width
- F9-292 15mm tip width

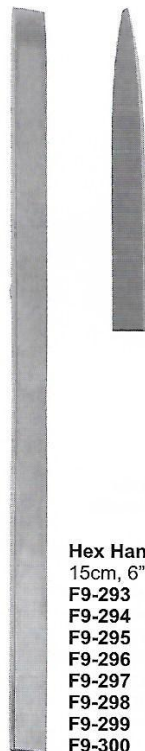

Hex Handle Osteotome

15cm, 6" Straight

- F9-293 2mm tip width
- F9-294 3mm tip width
- F9-295 4mm tip width
- F9-296 5mm tip width
- F9-297 6mm tip width
- F9-298 7mm tip width
- F9-299 9mm tip width
- F9-300 10mm tip width



Cottle Osteotome

18.5cm, 7 1/4" Straight

- F9-301 4mm tip width
- F9-302 6mm tip width
- F9-303 9mm tip width
- F9-304 12mm tip width



Anderson-Nievert Osteotome

20.4cm 8"

- F9-305 Curved right
- F9-306 Curved left
- F9-307 Straight

BONE CHISELS & GOUGES



Knochenmeißel
Ciseaux-burins, gouges

Cineles, gubias
Scalpelli, sgorbi



Stille
20cm 8"



Stille Chisel
F9-308 10mm
F9-309 15mm
F9-310 20mm
F9-311 25mm
Straight

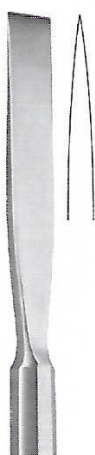

Stille Osteotome
F9-312 10mm
F9-313 15mm
F9-314 20mm
F9-315 25mm
Straight

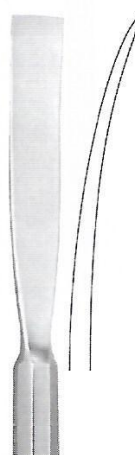

Stille Osteotome
F9-316 10mm
F9-317 15mm
F9-318 20mm
F9-319 25mm
Curved



Stille Gouge
F9-320 10mm
F9-321 15mm
F9-322 20mm
F9-323 25mm
Straight



Stille Gouge
F9-324 10mm
F9-325 15mm
F9-326 20mm
F9-327 25mm
Curved



Smith-Petersen
20cm 8"

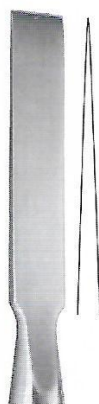

Smith-Petersen osteotome
F9-328 6mm
F9-329 9mm
F9-330 13mm
F9-331 16mm
F9-332 19mm
F9-333 25mm
F9-334 32mm
Straight

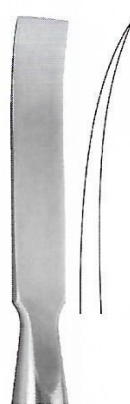

Smith-Petersen Osteotome
F9-335 6mm
F9-336 9mm
F9-337 13mm
F9-338 16mm
F9-339 19mm
F9-340 25mm
F9-341 32mm
Curved



Smith-Petersen Gouge
F9-342 9mm
F9-343 16mm
F9-344 19mm
F9-345 25mm
Straight



Smith-Petersen Gouge
F9-346 9mm
F9-347 16mm
F9-348 19mm
F9-349 25mm
Curved



BONE CHISELS & GOUGES

Knochenmeißel
Ciseaux-burins, gouges

Cineles, gubias
Scalpelli, sgorbi



Freer Gouge
F9-350 15cm 6"
06mm



Freer Chisel
F9-351 16cm 6 1/4"
04mm



Shoulder Penetrating Gouge
F9-352
21.6cm 8 1/2"
Straight, 3mm distal tip

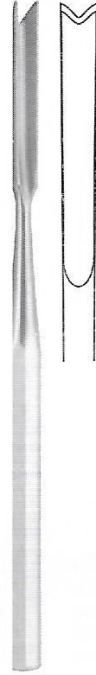

Ballenger Chisel
F9-353 04mm
F9-354 06mm
F9-355 08mm
16cm 6 1/4"



Mannerfelt Modif.



Osteotomes
F9-356 04mm
F9-357 06mm
F9-358 08mm
15.5cm 6"



Gouge
F9-359 03mm
15.5cm 6"



Kilian, Septum Gouge
F9-360 16cm 6 1/4"
05mm



Kilian-Claus Septum Gouge
F9-361 16cm 6 1/4"
05mm



Cottle Osteotome
F9-362 07mm
F9-363 12mm
15cm 6"



Cottle Osteotome
F9-364 19cm 7 1/2"
04mm



Cottle Osteotome with depth markings
F9-365 18cm 7"
06mm

BONE CHISELS & GOUGES



Knochenmeißel
Ciseaux-burins, gouges

Cineles, gubias
Scalpelli, sgorbi



Fomon Chisel
17cm 6 3/4"



F9-366
04mm



F9-367
05mm



F9-368
06mm



F9-369
07mm



F9-370
08mm



Cinelli Chisel
18cm 7"



F9-371
10mm



F9-372
12mm



F9-373
14mm



F9-374
16mm



Cottle Osteotome
18cm 7"



F9-375
04mm



F9-376
07mm



F9-377
09mm



F9-378
12mm



F9-379
04mm



F9-380
07mm



F9-381
09mm



F9-382
12mm

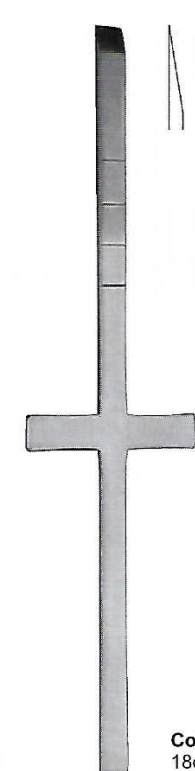

Cottle Chisel
18cm 7"



CHISELS, OSTEOTOMES FOR RHINOPLASTIC

Meißel zur nasenplastik

Osteotomes, ciseaux-burins pour rhinoplastique

Cinceles para rinoplastica

Scalpelli per plastica nasale



Sheehan osteotome
16cm 6 1/4"



F9-383
2mm



F9-384
4mm



F9-385
6mm

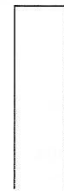

F9-386
8mm



F9-387
10mm



F9-388
12mm

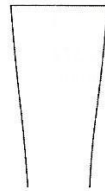

F9-389
15mm

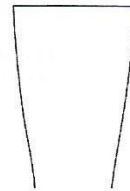

F9-390
18mm



Silver Rhinoplastic Chisel

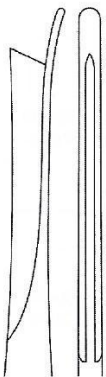

F9-391
18cm 7"
Straight



F9-392
18cm 7"
right

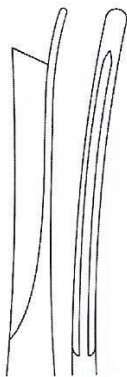

F9-393
18cm 7"
Left



Neivert-Anderson osteotome

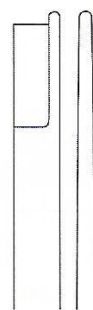

F9-394
20cm 8"
Straight

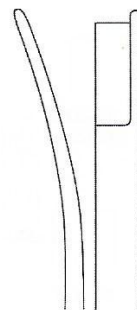

F9-395
20cm 8"
right

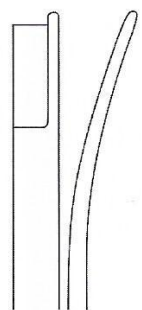

F9-396
20cm 8"
Left

TAMPERS



Stobel
Pilons

Punzones
Pestoni

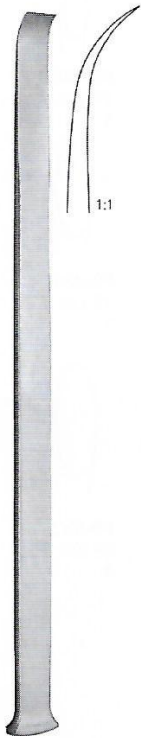

Obwegeser Osteotome
F9-397 23.5cm 9 1/4"
11mm



Obwegeser Blade osteotome
F9-398 7mm
21.5cm 8 1/2"



Obwegeser Blade osteotome
F9-399 10mm
21.5cm 8 1/2"



Bone Tamper

- F9-400**
15.5cm 6"
Head diameter
2mm
- F9-401**
15.5cm 6"
Head diameter
3mm
- F9-402**
15.5cm 6"
Head diameter
4mm
- F9-403**
15.5cm 6"
Head diameter
5mm
- F9-404**
15.5cm 6"
Head diameter
6mm
- F9-405**
15.5cm 6"
Head diameter
8mm
- F9-406**
15.5cm 6"
Head diameter
10mm



F9-407
2.5mm x 2.5mm

F9-408
3.5mm x 3.5mm

Passow Bone Tamper
12cm 4 3/4"



F9-409
3mm

F9-410
5mm

F9-411
8mm

Caspar Bone Tamper
20cm 8"



F9-412
12mm

F9-413
14mm

F9-414
16mm

Caspar Bone Tamper
20cm 8"



Tip Size
2 mm
3 mm
4 mm
5 mm
6 mm
8 mm
10 mm

Bone Tamps
F9-415
15.4 cm, 6"



BONE CURETTES

Scharfe Löffel

Curettes tranchantes

cucharillas cortantes

Cucchiai taglianti



**Volkman
Bone Curette**

F9-416
17 cm, 7"
0000

F9-419
17 cm, 7"
0



F9-422
17 cm, 7"
3



F9-417
17 cm, 7"
000

F9-420
17 cm, 7"
1

F9-423
17 cm, 7"
4

F9-418
17 cm, 7"
00

F9-421
17 cm, 7"
2



F9-424
17 cm, 7"
5



F9-425
17 cm, 7"
6



**Schede
Bone Curette**
17 cm, 6 3/4"



F9-426
17 cm, 7"
000

F9-429
17 cm, 7"
1

F9-427
17 cm, 7"
00

F9-430
17 cm, 7"
2

F9-428
17 cm, 7"
0

F9-431
17 cm, 7"
3

F9-432
17 cm, 7"
4



**Bruns
Bone Curette**

F9-433
17 cm, 7"
000

F9-435
17 cm, 7"
0

F9-437
17 cm, 7"
2

F9-439
17 cm, 7"
4

F9-434
17 cm, 7"
00

F9-436
17 cm, 7"
1



F9-438
17 cm, 7"
3



F9-440
17 cm, 7"
5



F9-441
17 cm, 7"
6





**Spratt Bone Curette
/ Hollow Handle**

F9-442
16.5 cm, 6 1/2"
00000



F9-445
16.5 cm, 6 1/2"
00

F9-448
16.5 cm, 6 1/2"
2

F9-443
16.5 cm, 6 1/2"
0000



F9-446
16.5 cm, 6 1/2"
0

F9-449
16.5 cm, 6 1/2"
3

F9-444
16.5 cm, 6 1/2"
000

F9-447
16.5 cm, 6 1/2"
1

F9-450
16.5 cm, 6 1/2"
4

F9-451
16.5 cm, 6 1/2"
5

BONE CURETTES



Scharfe Löffel

cucharillas cortantes

Curettes tranchantes

Cucchiai taglienti



**Schroeder
Bone Curette**
Sharp / rigid



F9-452
30.0 cm, 12"
1



F9-453
30.0 cm, 12"
2



F9-454
30.0 cm, 12"
3



F9-455
30.0 cm, 12"
4



F9-456
30.0 cm, 12"
5



F9-457
30.0 cm, 12"
6



**Simon
Bone Curette**
Sharp / rigid



F9-458
24.0 cm, 9 1/2"
0000



F9-459
24.0 cm, 9 1/2"
000



F9-460
24.0 cm, 9 1/2"
00



F9-461
24.0 cm, 9 1/2"
0



F9-462
25.0 cm, 9 3/4"
1



F9-463
25.0 cm, 9 3/4"
2



F9-464
25.0 cm, 9 3/4"
3



F9-465
25.0 cm, 9 3/4"
4



F9-466
25.0 cm, 9 3/4"
5



F9-467
25.0 cm, 9 3/4"
6



BONE CURETTES

Scharfe Löffel
Curettes tranchantes

cucharillas cortantes
Cucchiai taglianti

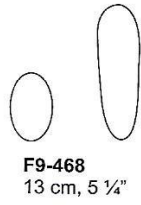

F9-468
13 cm, 5 1/4"

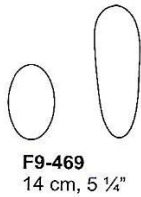

F9-469
14 cm, 5 1/4"

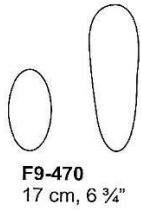

F9-470
17 cm, 6 3/4"

Volkmann
Curette
Oval / Oval

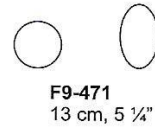
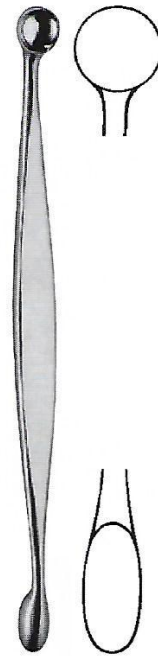

F9-471
13 cm, 5 1/4"

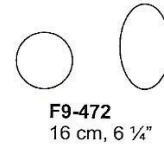

F9-472
16 cm, 6 1/4"

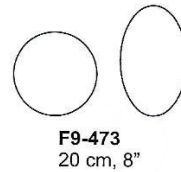

F9-473
20 cm, 8"

Volkmann
Curette
Round / Oval



Curette
F9-474
21cm 8 1/4"
round / oval

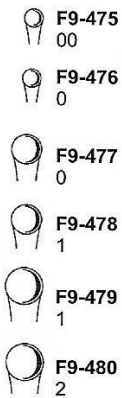

Martini
Curette
13.5 cm, 5 1/4"

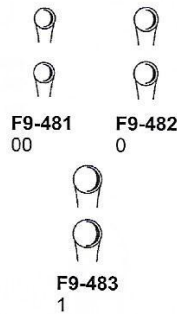

Martini
Curette
15.5 cm, 6"

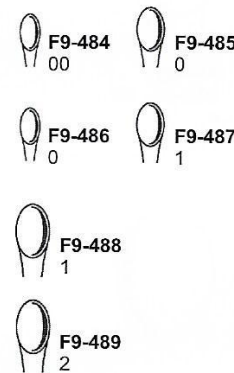

Williger
Curette
13.5 cm, 5 1/4"

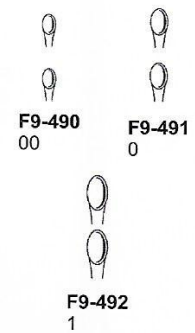

Williger
Curette
15.5 cm, 6"

BONE CURETTES



Scharfe Löffel
Curettes tranchantes

cucharillas cortantes
Cucchiai taglienti



Jansen Curette
F9-493
16 cm, 6 1/4"



Jansen Curette
F9-494
15 cm, 6"



Williger Curette
F9-495
13.25 cm, 5 1/2"
Double Ended
00/0



F9-496
13 cm, 5"
Double Ended
6.2 mm & 6.7 mm



F9-497
16 cm, 6 1/2"
Double Ended
7 mm & 9 mm

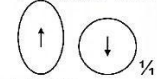

F9-498
20 cm, 8"
Double Ended
9.1 mm & 11.1 mm



Lucas Curette
double-ended
18 cm, 7"



Fig. 1 R/L
F9-499



Fig. 2 R/L
F9-500



Fig. 3 R/L
F9-501



Fig. 4 R/L
F9-502



PERIOSTEAL ELEVATORS

Raspatorien
Periostótomos

Rugines-raspatoires
Periostotomi

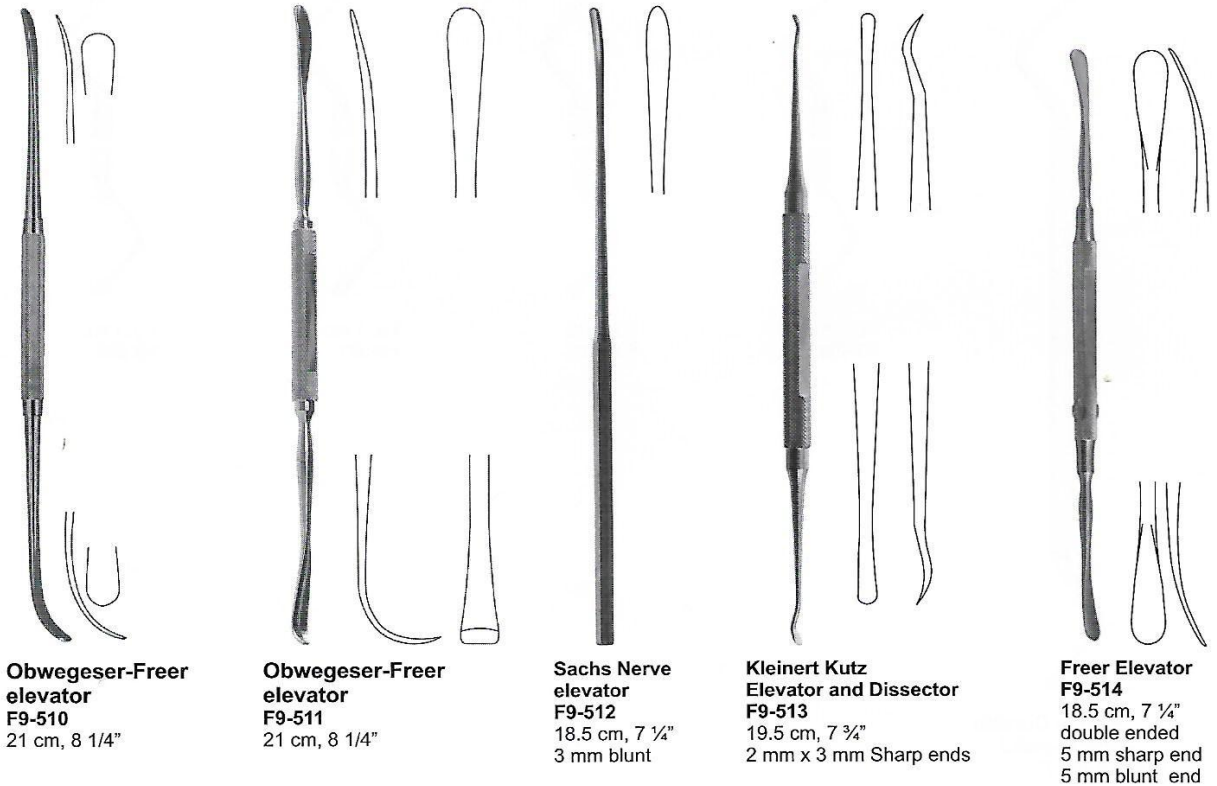
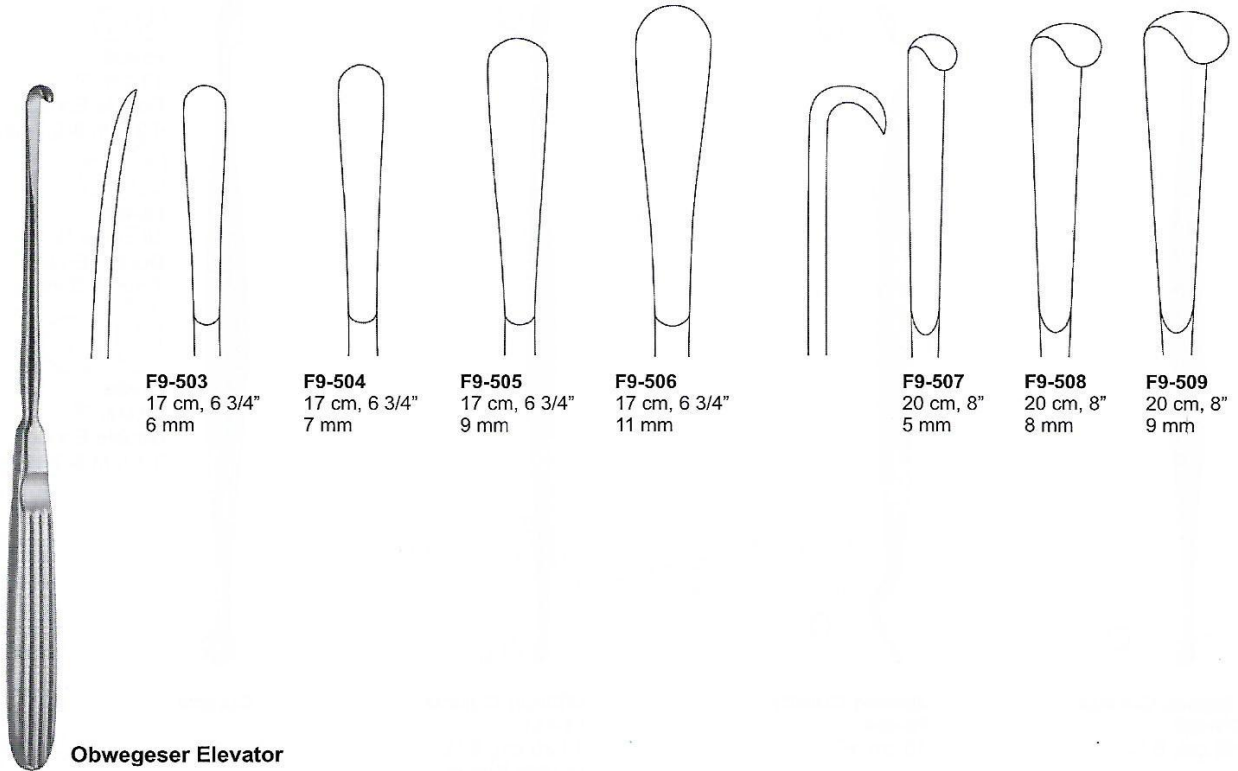

PERIOSTEAL ELEVATORS



Raspatorien
Periostótomos

Rugines-raspatoires
Periostotomi

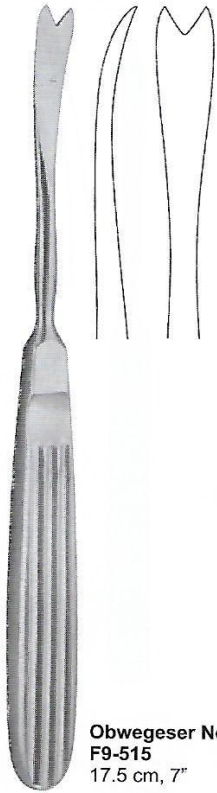

**Obwegeser Needle
F9-515**
17.5 cm, 7"



**Obwegeser Needle
F9-516**
23 cm, 9"



**Obwegeser Needle
F9-517**
18 cm, 7"



**Obwegeser Needle
F9-518**
14 cm, 5 1/2"

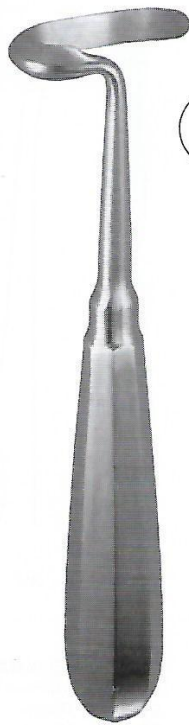

Doyen Rib Raspatory
17 cm, 7"



F9-519
Right Crved
For Adults

F9-520
Right Crved
For Children



Doyen Rib Raspatory
17 cm, 7"



F9-521
Left Crved
For Adults

F9-522
Left Crved
For Children

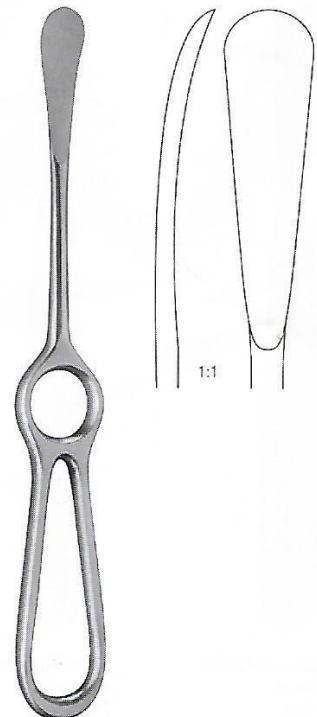

Sedillot Elevator
F9-523 18.5cm, 7 1/4"
F9-524 21.0cm, 8 1/4"



PERIOSTEAL ELEVATORS

Raspatorien
Periostótomos

Rugines-raspatoires
Periostotomi

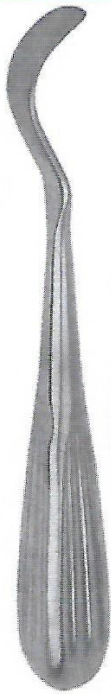

Grego Periosteal Elevator
F9-525
15.5cm, 6"



Williger Elevator
F9-526 13cm, 5"
5mm



Williger Elevator
F9-527 4mm
F9-528 6mm
16cm, 6 1/4"



Williger Elevator
F9-529
16cm, 6 1/4"
5mm



Williger Elevator
F9-530
16cm, 6 1/4"
6.5mm



Farabeuf-Collin Elevator
F9-531
16cm, 6 1/4"
11mm
Straight



Farabeuf-Collin Elevator
F9-532
16cm, 6 1/4"
11mm
Curved

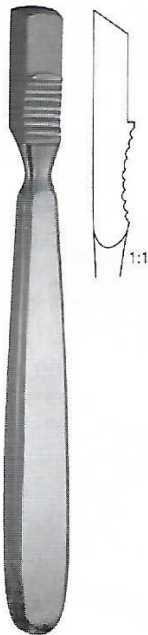

Farabeuf Elevator
F9-533
15cm, 6"
Straight

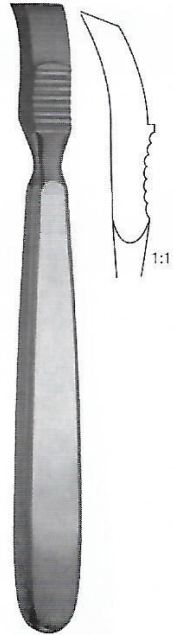

Farabeuf Elevator
F9-534
15cm, 6"
Curved



Lambotte Elevator
F9-535 5mm
F9-536 10mm
F9-537 15mm
F9-538 20mm
F9-539 25mm
21cm, 8 1/4" Straight

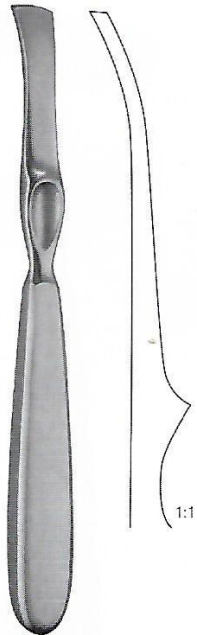

Lambotte Elevator
F9-540 5mm
F9-541 10mm
F9-542 15mm
F9-543 20mm
F9-544 25mm
21cm, 8 1/4" Curved

BONE LEVERS



Knochenhebel
Leviers a os

Elevadores para huesos
Elevatori per ossa



**Hohmann
Bone Elevator
F9-545** 43mm
24.5 cm, 9 1/2"

**Hohmann
Bone Elevator
F9-546** 22mm
26cm, 10 1/4"

**Hohmann
Bone Elevator
F9-547** 33mm
28cm, 11"

**Hohmann
Bone Elevator
F9-548** 24mm
26.5cm, 10 1/2"

**Hohmann
Bone Elevator
F9-549** 22mm
26cm, 10 1/4"



BONE LEVERS

Knochenhebel
Leviers a os

Elevadores para huesos
Elevatori per ossa



Capsule Retractor
F9-550 25.5cm 10"
3 sharp-pronged,
22mm width blade



**Bristow-Bankart
Humeral Retractor**
F9-551 19.0cm 7 1/2"
Double-pronged,
25mm width x 102mm
depth blade



**Bristow-Bankart Soft
Tissue Retractor**
F9-552 20.0cm 7 7/8"
3-pronged
21mm width blade,



Humeral Head Retractor
F9-553 22.0cm 8 3/4"
18mm width blade



Hohmann Bone Elevator
F9-554 22cm, 8 3/4"
08mm width blade
F9-555 23.0cm 9"
10mm width blade

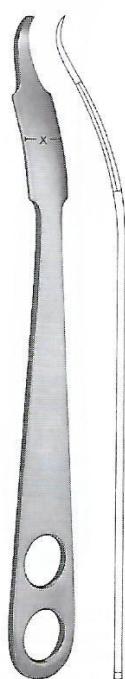

Hohmann Bone Elevator
F9-556 24cm, 9 1/2"
18mm



Hohmann Bone Elevator
F9-557 24cm, 9 1/2" 70mm
F9-558 28.5cm 11 1/4" 35mm width blade
F9-559 33.0cm 13" 40mm width blade



**Hohmann Long Shank
Retractor**
F9-560 23.0cm 9"
43mm width blade

BONE LEVERS



Knochenheber
Leviers a os

Elevadores para huesos
Elevatori per ossa



**Mini-Hohmann
Bone Elevator**

F9-561

16cm, 6 1/4"

6mm width blade



1:1



1:1

F9-562

16cm, 6 1/4"

8mm width blade



**Hohmann
Bone Lever
F9-563**
15 cm, 6"



**Hohmann
Bone Lever
F9-564**
15.4 cm, 6"
Short tip



**Hohmann Retractor
F9-565**
15.0cm 6"
15mm width blade



**Hayes Hand Retractor
F9-566** 16.0cm 6 1/4"
3mm width blade



**Hayes Hand Retractor
F9-567** 15.0cm 6"
6mm width blade



Bone Lever

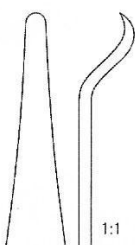

1:1

F9-568 14cm, 5 1/2"
2.8mm



1:1

F9-569 14cm, 5 1/2"
4.5mm

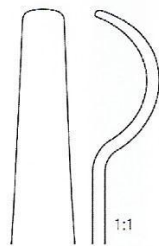

1:1

F9-570 14cm, 5 1/2"
6mm

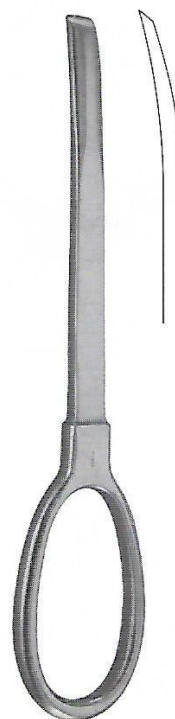

**Bristow Bone Lever
F9-571** 23cm, 9"



**Lane Bone Lever
F9-572**
21cm, 8 1/4"



BONE LEVERS

Knochenhebel
Leviers a os

Elevadores para huesos
Elevatori per ossa

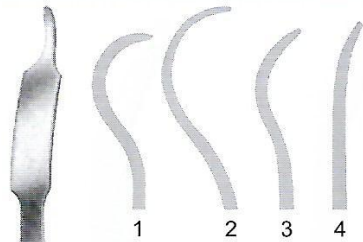

Periosteal Elevator 17.5 cm, 7"
For Metacarpals Small
F9-573 6 mm width
For Metacarpals Medium
F9-574 10 mm width
Light Curve, Rounded End,
F9-575 5 mm width
Contra Angled Curve
F9-576 4.5 mm width



Hohmann Retractor
F9-577 18 cm, 7"
Small, width 6 mm
short, narrow tip



Hohmann Retractor
F9-578 18 cm, 7"
Small, width 8 mm
short, narrow tip



Hohmann Retractor
F9-579 12.5 cm, 5"
Finger Ring handle,
16mm width blade

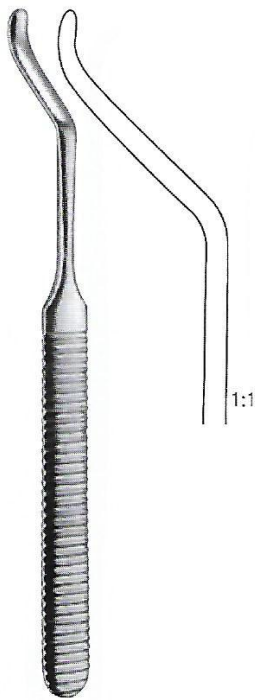

Hohmann-Williger
Retractor
F9-580 16 cm, 6 1/4"

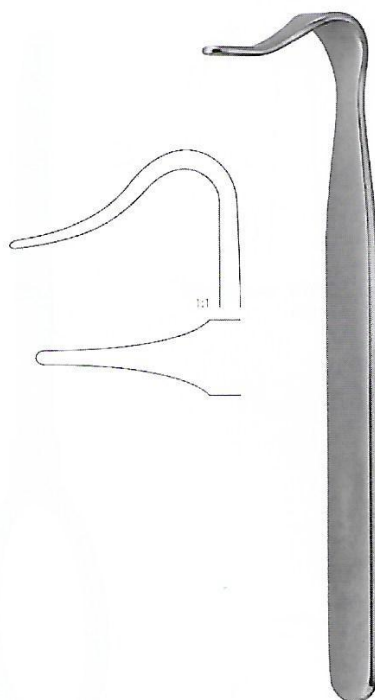

Blount Retractor
F9-581
17.5cm, 7"



Taylor Retractor.
16.5cm, 6 1/2"
F9-582 a=75mm - b=30mm
F9-583 a=100mm - b=30mm

BONE LEVERS



Knochenhebel
Leviers a os

Elevadores para huesos
Elevatori per ossa



Cushing Vein Retractor
F9-584 22.5 cm, 9"
with fenestrated handle
Blade 12 mm width x 10 mm



Cushing Decompression Retractor
F9-585 21.5 cm, 8 1/2"
with fenestrated blade and handle
Blade 13 mm width x 22 mm



Scoville Nerve Retractor
F9-586
24 cm, 9 1/2", 7 mm
straight



Scoville Nerve Retractor
F9-587
24 cm, 9 1/2", 7 mm
angled

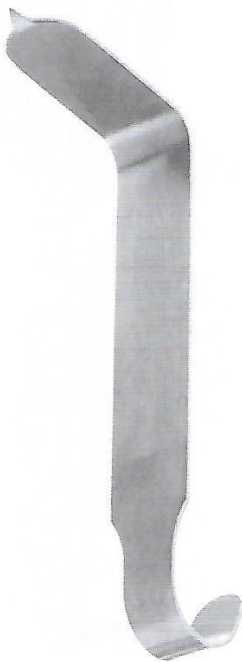

Taylor Retractor
17 cm, 6 3/4"
F9-588 30 x 75 mm
F9-589 30 x 100 mm



Hibbs Retractor
F9-590 25 x 75 mm, 23 cm, 9"
F9-591 25 x 80 mm, 24 cm, 9 1/2"



Meyerdig Retractor
F9-592 16 X 50 mm, 20 cm, 8"
F9-593 25 X 75 mm, 23 cm, 9"
F9-594 50 X 90 mm, 24 cm, 9 1/2"



MENISCOTOMY KNIVES

Meniskotome

Bisturios para meniscos

Bistouries a menisques

Bisturi per menisco



Bircher Meniscotomy Knife
F9-595
19cm 7 1/2"

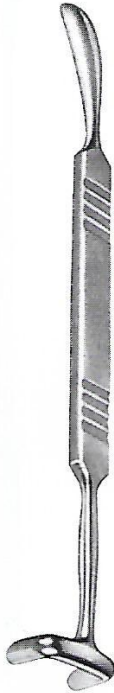

Matson Meniscotomy Knife
F9-596
22 cm, 9"



Downing Cartilage Knife
F9-597 25.5cm 10"
Curved tip, Straight shaft

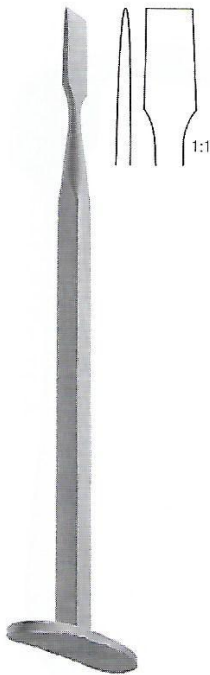

Smillie Meniscotomy Knife
F9-598
16cm 6 1/4" Straight shaft,
Blade tip width is 7.8mm
Straight tip

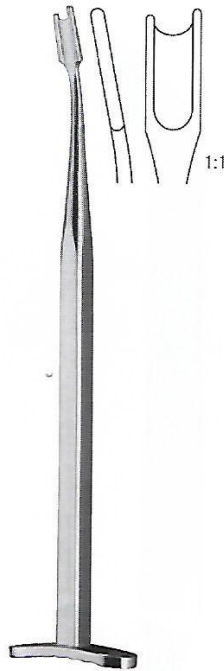

Smillie Meniscotomy Knife
F9-599
16cm 6 1/4" curved shaft,
Blade tip width is 7.8mm
Curved left tip

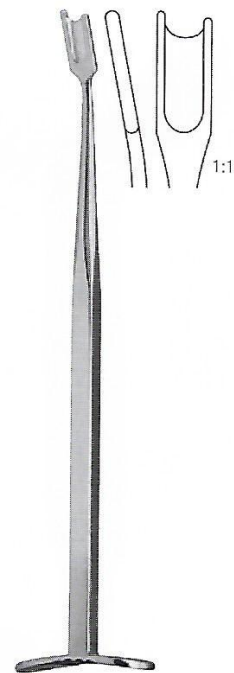

Smillie Meniscotomy Knife
F9-600
16cm 6 1/4" Curved shaft,
Blade tip width is 7.8mm
Curved left tip

ORTHOPAEDICS

Orthopädie
Ortopedia

Orthopédie
Ortopedia



**Nail Extracting Forceps
F9-601**
14 cm, 5 1/2"

**Nail Extracting Forceps
F9-602**
14.5 cm, 5 3/4"



**Finger Nail Drill
with 3 drill points
F9-603**

Frill points only

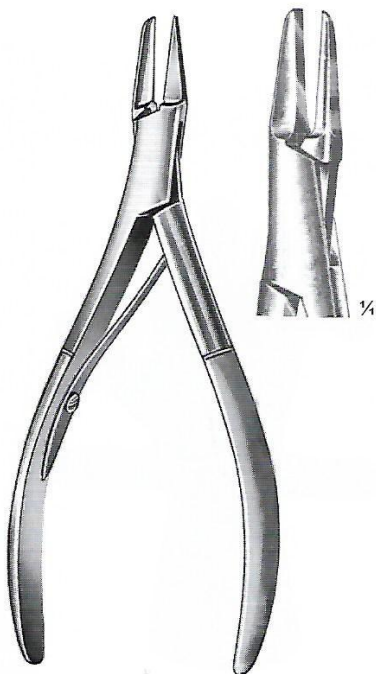

**Nail Splitting Forceps
F9-607**
13.5 cm, 5 1/4"



**F9-609
Saw Blade Only
for F9-608**

**Ring Cutter
F9-608**
17 cm, 6 3/4"



**F9-611
Saw Blade Only
for F9-610**

**Ring Cutter
F9-610**
17 cm, 6 3/4"



TENDON STRIPPERS

Sehnenstripper
Instruments a ecorcher les tendons

enucleadores de tendones
Scollatendini

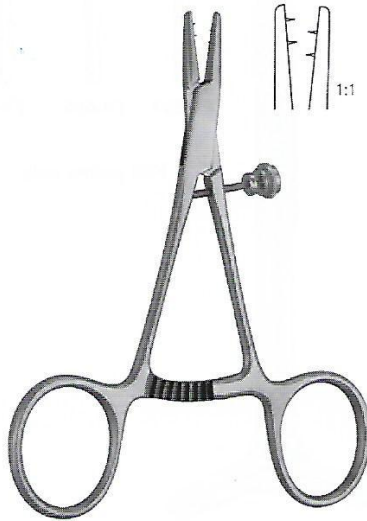

Tendon Tunelling Forceps
F9-612
13cm 5"



Tendon Tunelling Forceps

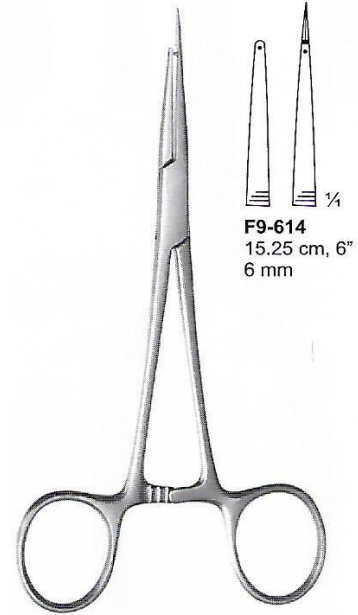

Tendon Tunelling Forceps

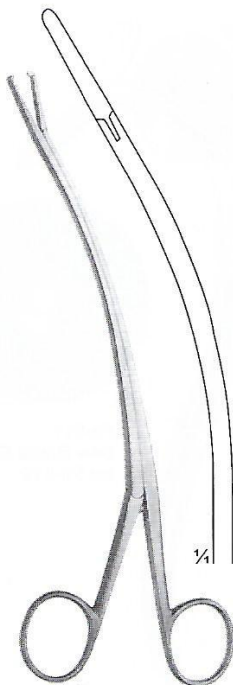

Brand Tendon Forceps
F9-615 15 cm, 6"
F9-616 19 cm, 7 1/2"
F9-617 24 cm, 9 1/2"



Carroll Tendon Forceps
F9-618 13 cm, 5"
Curved Shaft
2 mm x 6 mm



Lead Hand
F9-619
Adult Size

TENDON STRIPPERS



Sehnenstripper

Instruments a ecorcher les tendons

enucleadores de tendones

Scollatendini

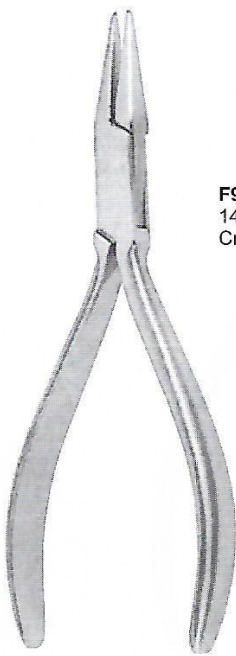

Needle Nose Pliers



F9-620
14 cm, 5 1/2"
Cross serrated

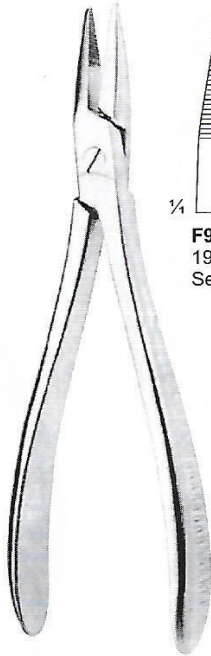

Needle Nose Pliers

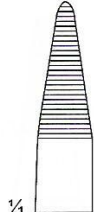

F9-621
19 cm, 7 1/2"
Serrated

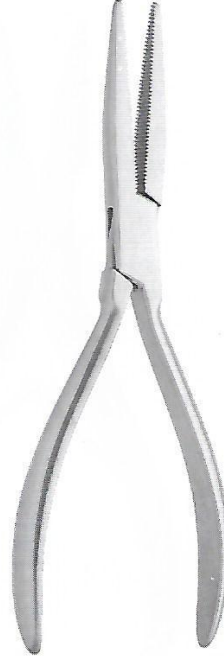

Flat Nose Plier
F9-622
18 cm, 7"



Flat Nose Pliers
F9-623
13.5cm 5 3/8"
Broad, 4mm tip,



Flat Nose Pliers
F9-624
16.5cm 6 1/2"
Combination plier and
cutter



Needle Nose Pliers
F9-625
13.5cm 5 3/8"



Flat Nose Pliers
F9-626
15cm 6" Delicate, 1.5mm tip



K-Wire Extraction Pliers
W/Screw Lock
F9-627
13cm 5" 3mm tip



TECHNICAL FORCEPS

Technische Zangen
Pinces techniques

Pinzas técnicas
Pinze tecniche



Flat Nose K-Wire Pliers
F9-628 14.0cm 5 1/2"
F9-629 17.0cm 6 3/4"

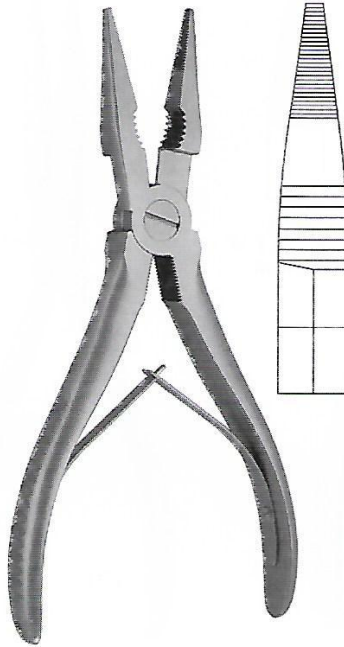

Nose Pliers
F9-630
17cm 6 3/4"



Pin Puller W/ Groove TC
F9-631
14.0cm 5 1/2"



Utility Technical Forceps Pliers
F9-632 19cm 7 1/2"
adjustable



Vital Heavy Duty Pliers TC
F9-633 22cm 8 3/4"
Grip Forceps, Combined with cutter

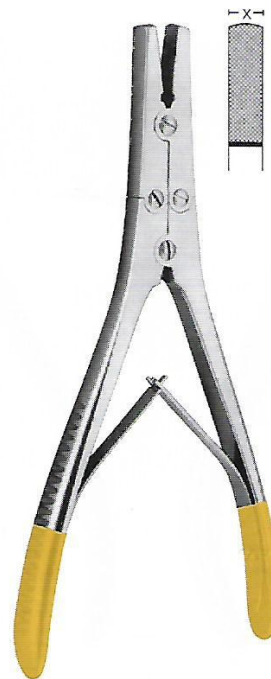

Vital Wire Extraction Pliers T.C
F9-634 5mm
F9-635 7mm
18cm 7"

TECHNICAL FORCEPS

Technische Zangen
Pinces techniques

Pinzas técnicas
Pinze tecniche

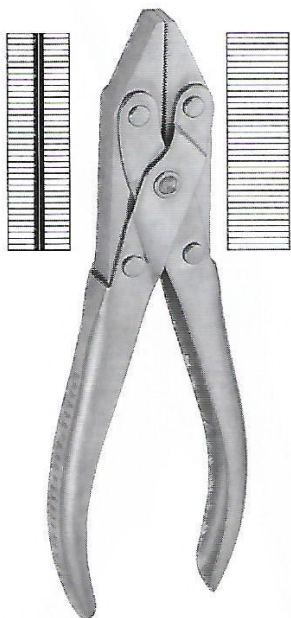

Wire Bending Forceps
F9-636 18.5.0cm 7 1/4"



Flat Nose Plier
F9-637 18.5.0cm 7 1/4"
parallel grip, incorporated
cutter, for hard wires up to
1.6mm



Locking Plier
F9-643 22cm 8 3/4"
F9-644 25cm 9 3/4"
F9-645 30cm 12"
Locking plier, only
F9-646 30cm 12"
with holding pins
F9-647 46cm 18"
with extraction device

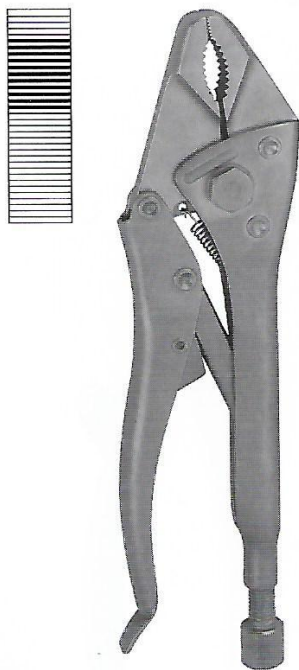

Locking Plier
F9-638 18cm 7"
F9-639 20cm 8"
F9-640 24cm 9 1/2"



Plate Bending Plier
F9-641 20cm 8"
for plates up to 2.7mm
F9-642 24cm 9 1/2"
for plates up to 4mm



TECHNICAL FORCEPS

Technische Zangen
Pinces techniques

Pinzas tecnicas
Pinze tecniche



Needle-Nose Locking Pliers
F9-648



Needle-Nose Locking Pliers
F9-649



Needle-Nose Locking Pliers
F9-650

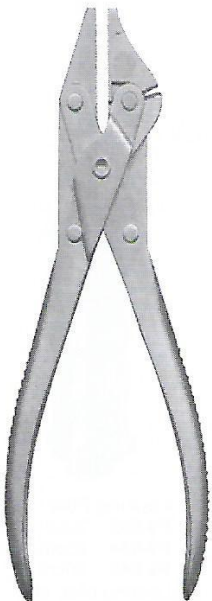

Flat Nosed Plier
F9-651 18 cm, 7"
parallell, with lateral
wire cutter



Cast Spreader
Model Usa
F9-652 23 cm, 9"
3 Prong

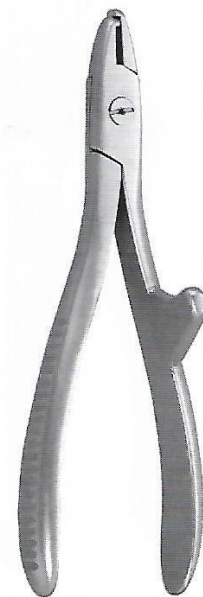

Nail Extractor
F9-653 16 cm, 6 1/2"
with Longitudinal Groove
(for Intramullary Gliding Nails)

BONE RONGEURS



Hohlmeißelzangen
Pinzas gubias

Pinces-gouges
Pinze-sgorbie

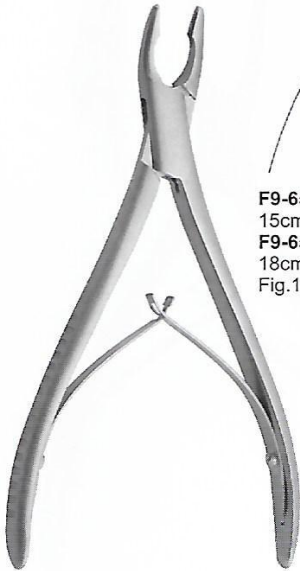

F9-654
15cm 6"
F9-655
18cm 7 1/8"
Fig.1

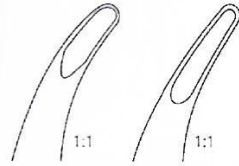

F9-656
15cm 6"
F9-657
18cm 7 1/8"
Fig.2

Luer Bone Rongeur
Single action
Curved, 8 x 12mm

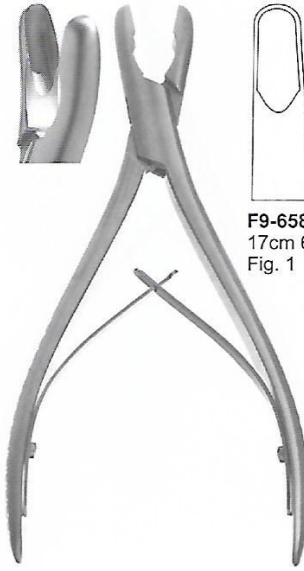

F9-658
17cm 6 3/4"
Fig. 1



F9-659
17cm 6 3/4"
Fig. 2

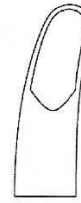

Luer Bone Rongeur
Single action,
Straight, 8 x 12mm



Friedmann Bone Rongeur
F9-660 14.5cm 5 3/4"
Single action, Curved,
4 x 11mm,

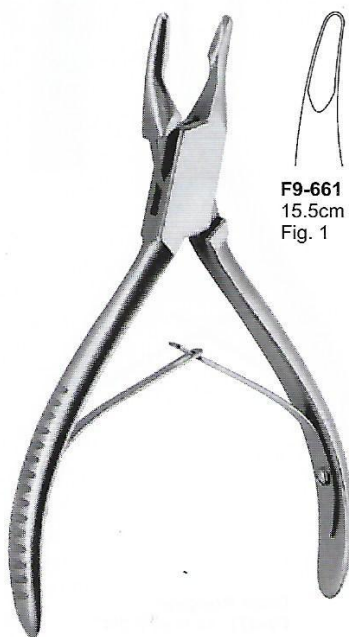

F9-661
15.5cm 6"
Fig. 1



F9-662
15.5cm 6"
Fig. 2



F9-663
15.5cm 6"
Fig. 3



Blumenthal Bone Rongeur

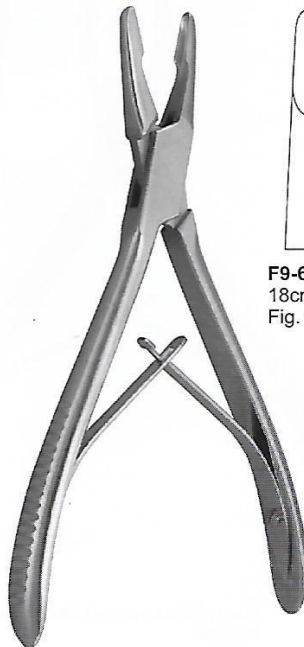

F9-664
18cm 7"
Fig. 1



F9-665
18cm 7"
Fig. 2



Jasen Bone Rongeur

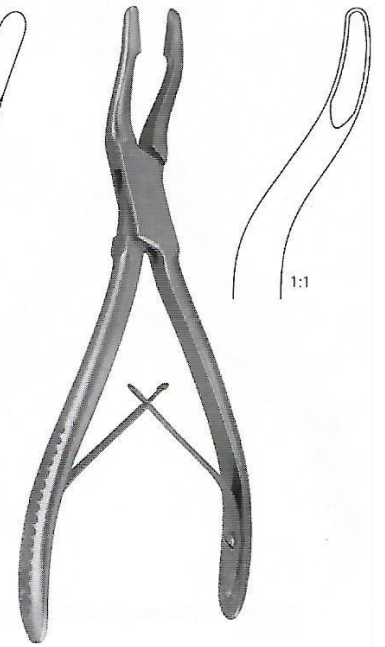

Jansen Bone Rongeur
F9-666 19cm 7 1/2"

1:1



BONE RONGEURS

Hohlmeißelzangen
Pinzas gubias

Pinces-gouges
Pinze-sgorbie

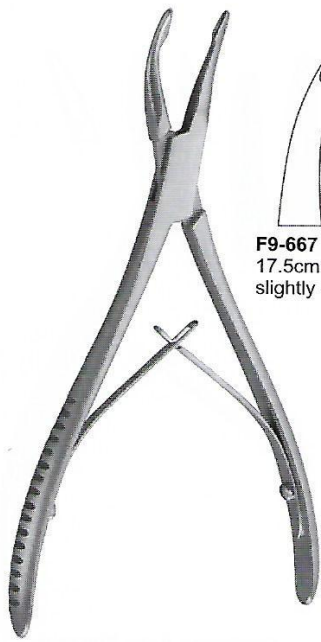

F9-667
17.5cm 7"
slightly curved

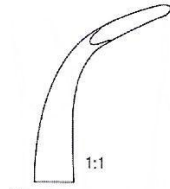

F9-668
17.5cm 7"
Strongly curved

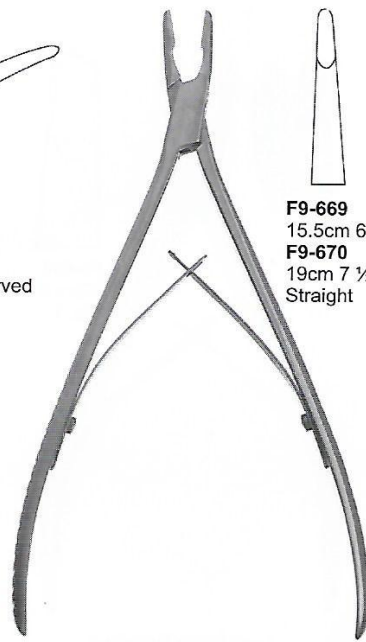

F9-669
15.5cm 6 1/8"
F9-670
19cm 7 1/2"
Straight



F9-671
15.5cm 6 1/8"
F9-672
19cm 7 1/2"
Curved

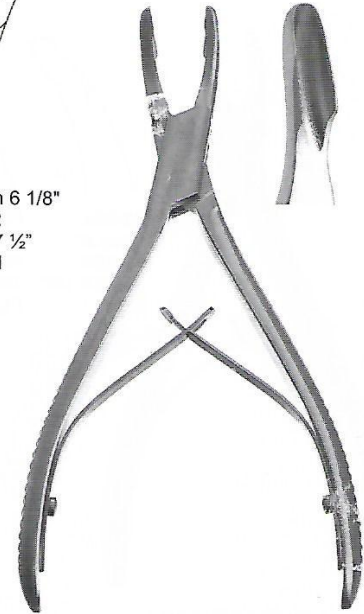

Rongeur #4
F9-673 14cm 5 1/2"
Rongeur #4A
F9-674 16.5cm 6 1/2"
Single action,
Curved, 4 x 9mm



Chichirelli (Blumenthal) Rongeur
F9-675
15cm 6"
Single action, Curved 45°,
4 x 13mm



Dean (Blumenthal) Rongeur
F9-676
15cm 6"
Single action,
Curved 90°, 4 x 11mm

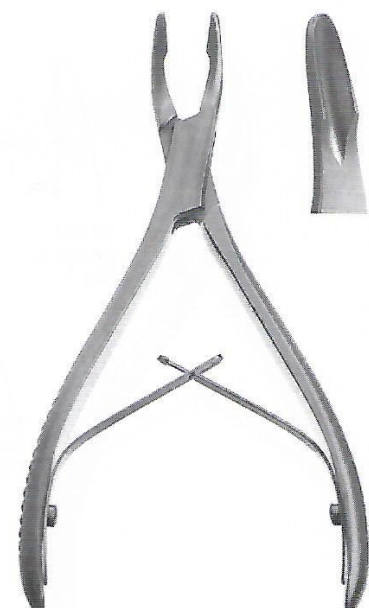

Dean Rongeur
F9-677 14.5cm 5 3/4"
Single action
Curved, 3mm



BONE RONGEURS



Hohlmeißelzangen
Pinzas gubias

Pinces-gouges
Pinze-sgorbie

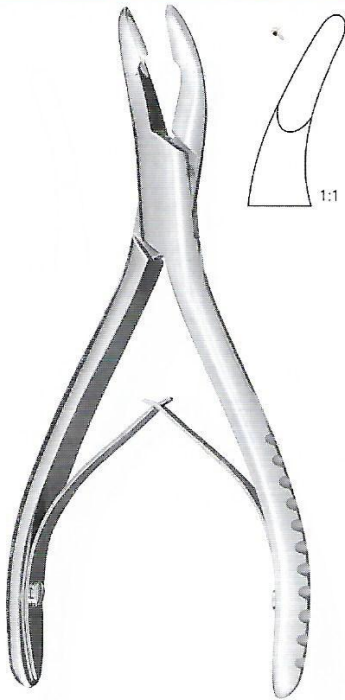

Hartmann Bone Rongeur
F9-678 18.5cm 7 1/4"
Single action
Curved, 4 x 14mm

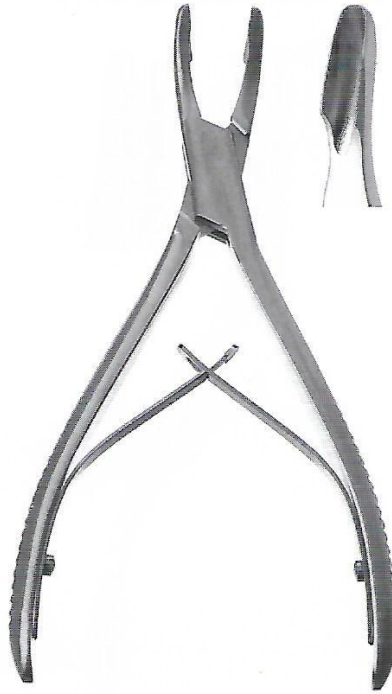

Mead Bone Rongeur
F9-679 16.5cm 6 1/2"
Single action,
Curved, 5 x 13mm



Cleveland Bone Rongeur
F9-680
14cm 5 1/2"



Cleveland Bone Rongeur
F9-681
17cm 6 3/4"

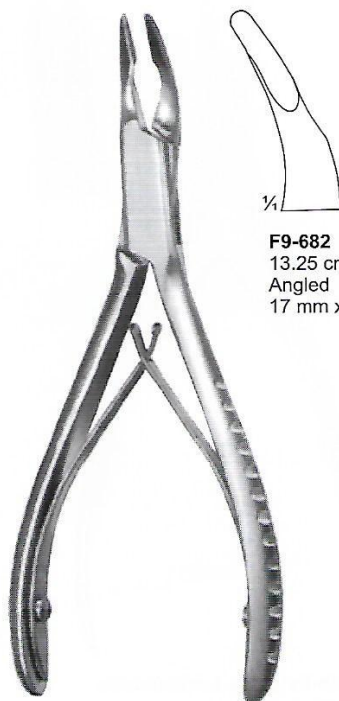

F9-682
13.25 cm, 5 1/2"
Angled
17 mm x 3.5 mm

Universal Bone Rongeur

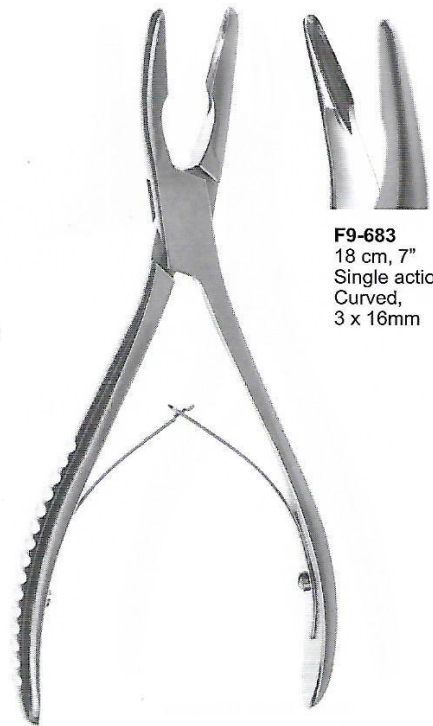

F9-683
18 cm, 7"
Single action
Curved,
3 x 16mm

Bane Bone Rongeur



BONE RONGEURS

Hohlmeißelzangen

Pinzas gubias

Pinces-gouges

Pinze-sgorbie

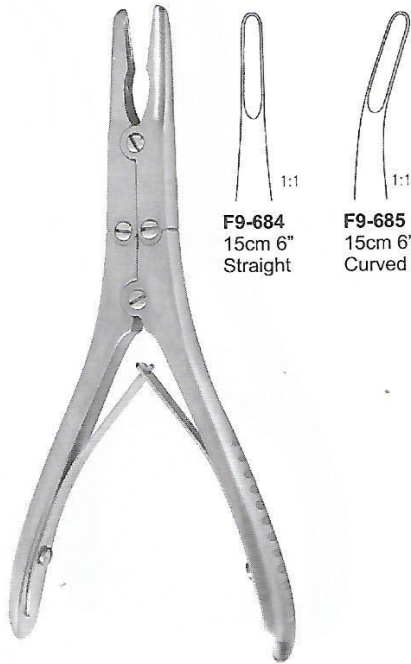

F9-684
15cm 6"
Straight

F9-685
15cm 6"
Curved

Bohler Bone Rongeur



Zaufal-Jansen Bone Rongeur
F9-686 18cm 7"
Double action
Curved, 5x15mm



Marquardt Bone Rongeur
F9-687
18cm 7"



Beyer Bone Rongeur
7" 18cm
F9-688 3 x 14mm
F9-689 4 x 15mm
Double action, Curved



Smith-Peterson Laminectomy Rongeur
F9-690 24cm 9 1/2"
Double action,
Straight 3 x 16mm



Smith-Peterson Laminectomy Rongeur
F9-691 24cm 9 1/2"
Double action
Curved 3 x 16mm

BONE RONGEURS



Hohlmeißelzangen
Pinzas gubias

Pinces-gouges
Pinze-sgorbie



Ruskin Rongeur
F9-692 18cm 7 1/8" 4 x 16mm
F9-693 18.5cm 7 1/4" 5 x 10mm
Double action, Curved on side



Ruskin Rongeur
F9-694 18.5cm 7 1/4"
Double action, 6 x 16mm,
Straight, Curved



Ruskin Rongeur
F9-695 15.5cm 6" Straight, 3.2mm
F9-696 15cm 6" Curved, 2 x 15mm
F9-697 15cm 6" Curved, 3 x 15mm
Double action,



Riskin Bone Rongeur



F9-698 15.5cm 6"
F9-699 18cm 7"
Double action
Straight, 2 x 14mm

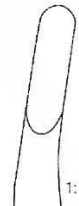

F9-700 15.5cm 6"
F9-701 18cm 7"
Double action
Curved 2 x 14mm



Mayfield Bone Rongeur
F9-702 18cm 7"

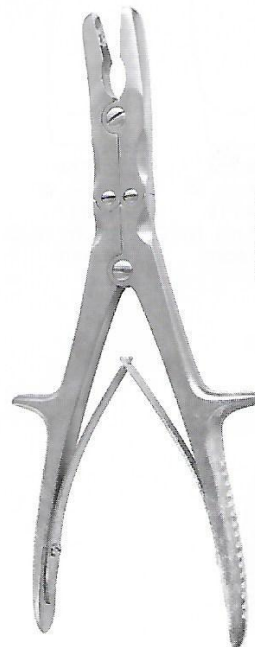

Stille-Ruskin Bone Rongeur

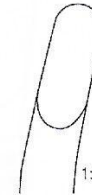

F9-703
23cm 9"
Curved

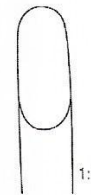

F9-704
23cm 9"
Straight



BONE RONGEURS

Hohlmeißelzangen
Pinzas gubias

Pinces-gouges
Pinze-sgorbie

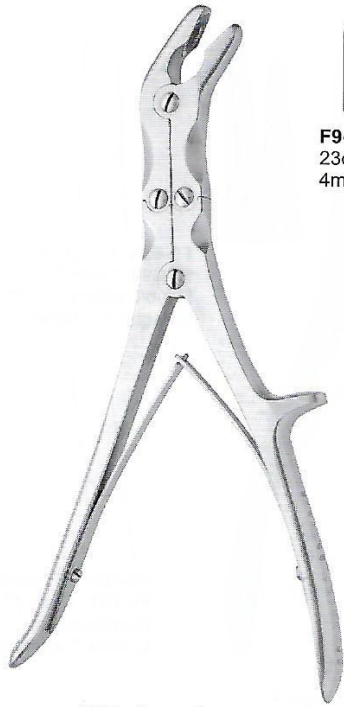

Stille Bone Rongeur

- F9-705**
23cm 9"
4mm
- F9-706**
23cm 9"
6mm
- F9-707**
23cm 9"
8mm



Leksell Bone Rongeur
F9-708 24.5cm 9 5/8" 5 x 13mm
F9-709 24cm 9 1/2" 8 x 14.5mm
Double action, Curved 50°

- Leksell Rongeur**
F9-710 24cm 9 1/2"
6 x 15mm
F9-711 24cm 9 1/2"
7 x 13mm
Double action, Curved

- Leksell Rongeur**
F9-712 24cm 9 1/2"
3 x 18mm
Double action, Curved

- Leksell Rongeur**
F9-713 23cm 9"
4 x 13mm
Double action
Fully curved

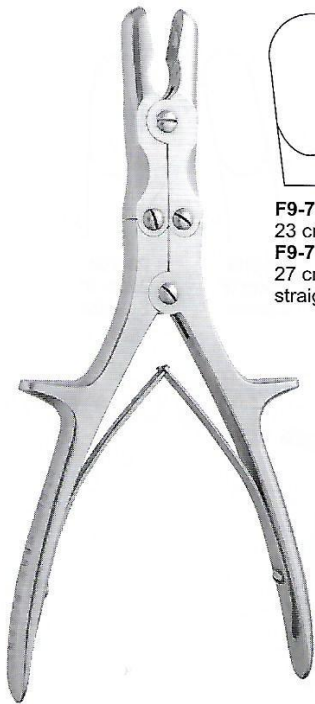

Stille-Luer Rongeur Forceps

- F9-714**
23 cm, 9"
F9-715
27 cm, 10 1/2"
straight
- F9-716**
23 cm, 9"
F9-717
27 cm, 10 1/2"
curved



Echlin Duckbill Bone Rongeur
23cm 9"

- F9-718**
2 x 12mm
Double action
Curved on side
- F9-719**
3 x 12mm
Double action
Curved on side

- F9-720**
4.5 x 11mm
Double action
Curved on side

BONE RONGEURS



Hohlmeißelzangen
Pinzas gubias

Pinces-gouges
Pinze-sgorbie



Stille-Leur Rongeur
F9-721 21.5cm 8 1/2"
Curved, Straight
Double action, 10 x 18mm



Stille-Leur Rongeur
F9-722 26.5cm 10 1/2"
Straight, Curved
Double action, 10 x 18mm



Stille-Luer Echlin Duckbill Rongeur
23cm 9"
F9-723 6 x 13mm
F9-724 6 x 15mm
Double action Curved on side



Stille-Leur Rongeur
F9-725 21.5cm 8 1/2"
Double action
Curved 10 x 16mm



BONE RONGEURS

Hohlmeißelzangen
Pinzas gubias

Pinces-gouges
Pinze-sgorbie



Rottgen-Ruskin Bone Rongeur
F9-726 23cm 9"

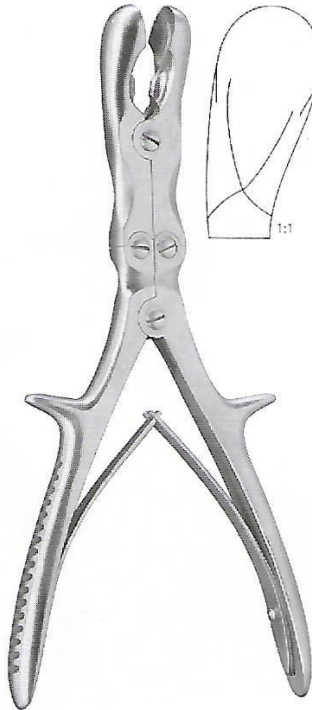

Semb Bone Rongeur
F9-727 24cm 9 1/2"



Fryholm Bone Rongeur
F9-728 24cm 9 1/2"

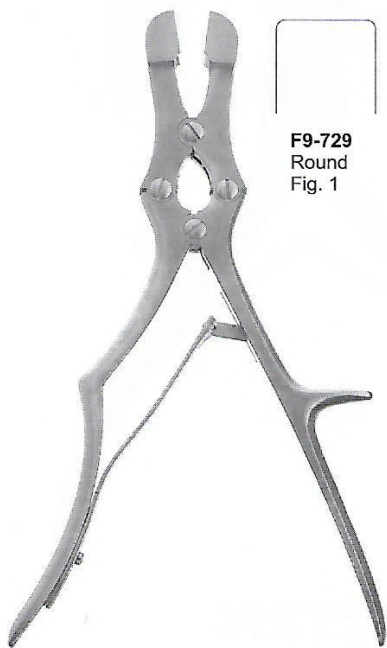

Sauerbruch Bone Rongeur
30 cm, 12"



F9-729
Round
Fig. 1

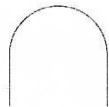

F9-730
Straight
Fig. 2



Luer-Stille Bone Rongeur
27 cm, 10 3/4"

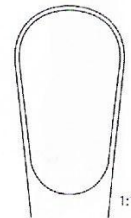

F9-731
Fig. 1

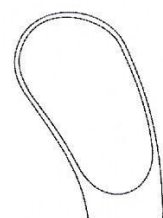

F9-732
Fig. 2

BONE RONGEURS



Hohlmeißelzangen
Pinzas gubias

Pinces-gouges
Pinze-sgorbie

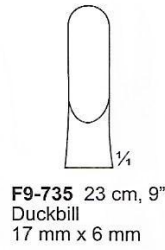
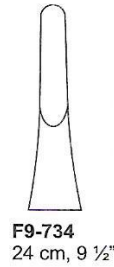
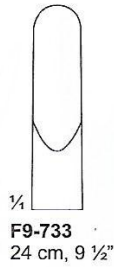
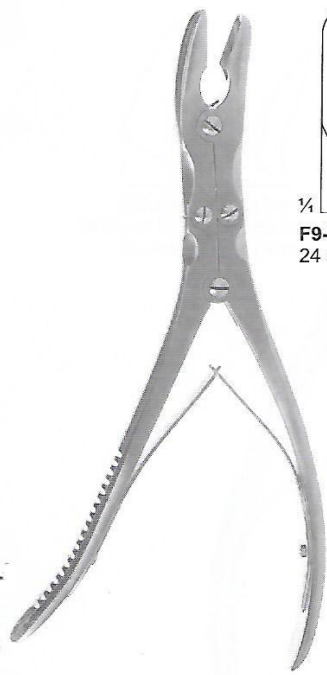

F9-736 25cm 9 3/4" 3 x 16mm
F9-737 23cm 9" 5 x 16mm
F9-738 25cm 9 3/4" 4.5 x 16mm
F9-739 25cm 9 3/4" 6 x 16mm
F9-740 25cm 9 3/4" 7 x 16mm
F9-741 25cm 9 3/4" 8 x 16mm
Double action, Curved 15°

Leksell-Stille Bone Rongeur

Stille Bone Rongeur

Leksell Bonerongeur



Hakansson Bone Rongeur
F9-742 20cm, 8"

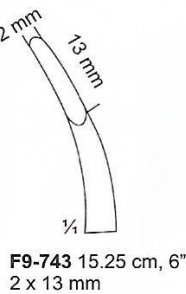

Kleinert-Kutz Bone Rongeur

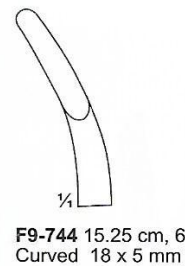
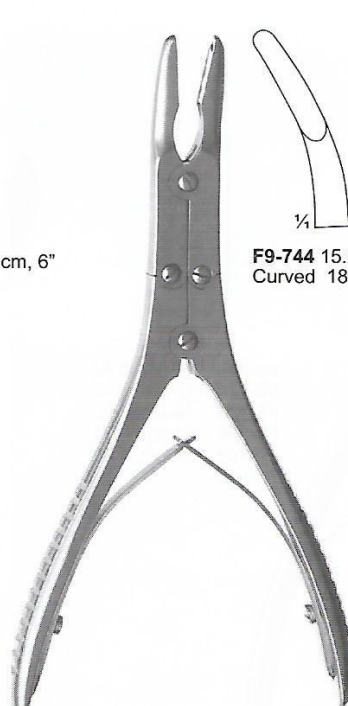

Ruskin-Mini Bone Rongeur

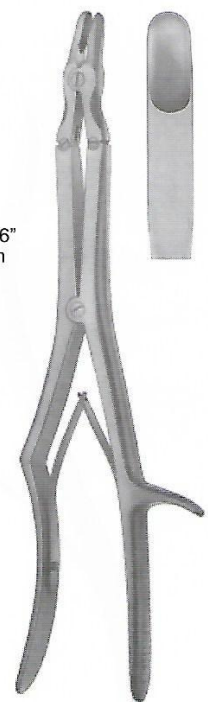

Sybert Rongeur
F9-745 35.5cm 14" 4 x 16mm
F9-746 35.5cm 14" 8 x 16mm
F9-747 35.5cm 14" 12 x 16mm
F9-748 37cm 14 1/2" 5 x 16mm
Double action, Angled



BONE CUTTING FORCEPS

Knochensplitterzangen
Pinces coupantes a os

Pinzas cortantes para huesos
Cesoie per ossa

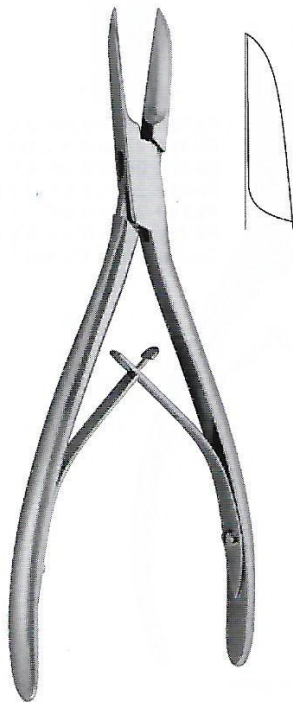

Cottle-Kazanjian Bone Cutting Rongeur Forceps
F9-749 19 cm, 7 1/2"

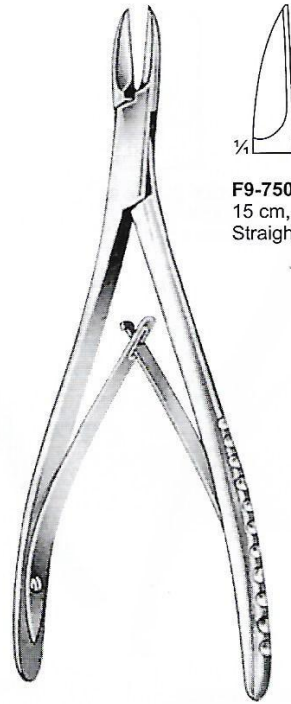

Littauer / Liston Bone Cutting Rongeur Forceps

F9-750
15 cm, 6"
Straight,

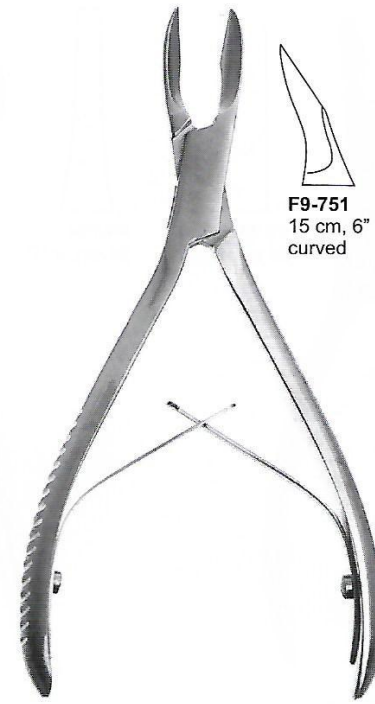

Cleveland Bone Cutting Rongeur Forceps

F9-751
15 cm, 6"
curved

F9-752
17 cm, 6 3/4"
curved

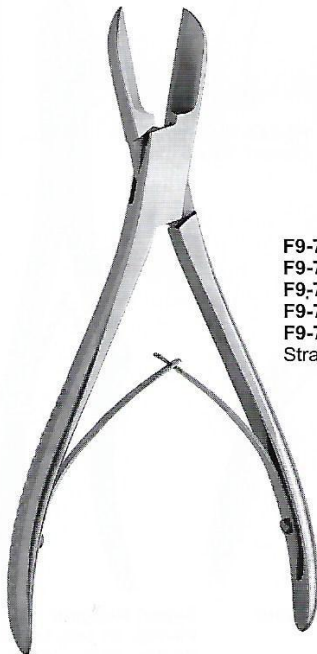

Liston Bone Cutting Rongeur Forceps

F9-753 14 cm, 5 1/2"
F9-754 17 cm, 6 3/4"
F9-755 19 cm, 7 1/2"
F9-756 20 cm 7 7/8"
F9-757 22 cm, 8 5/8"
Straight



Liston Bone Cutting Rongeur Forceps

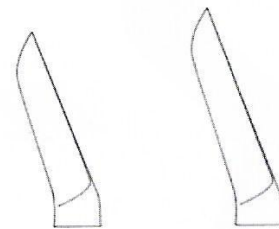

F9-758
14 cm, 5 1/2"
Angled

F9-759
17 cm, 6 3/4"
Angled

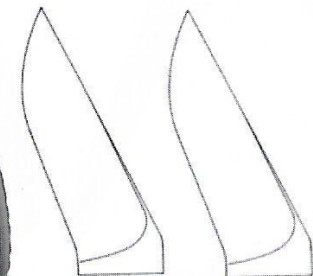

F9-760
19 cm, 7 1/2"
Angled

F9-761
22 cm, 8 3/4"
Angled

BONE CUTTING FORCEPS



Knochensplitterzangen
Pincas coupantes a os

Pinzas cortantes para huesos
Cesoie per ossa



Stille-Liston Bone Cutting Rongeur Forceps

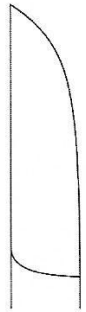

F9-762
27 cm, 10 3/4"
Straight

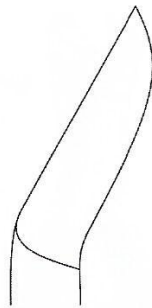

F9-763
27 cm, 10 3/4"
Angled 45°

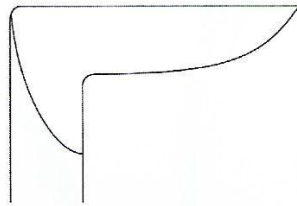

F9-764
27 cm, 10 3/4"
Angled 90°



Semb Bone Cutting Rongeur Forceps
F9-765 24 cm, 9 1/2"



Liston Key Horsley Bone Cutting Rongeur Forceps
F9-766 27 cm, 10 3/4"

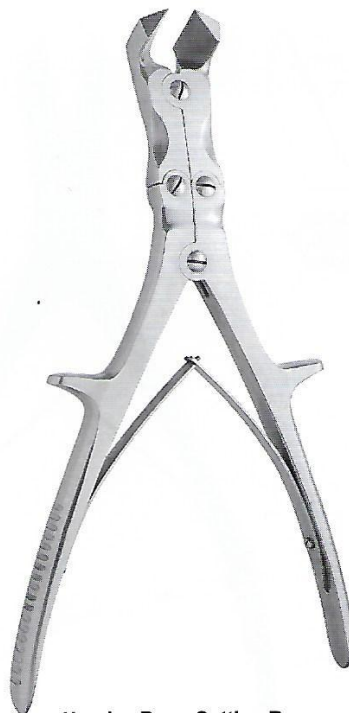

Horsley Bone Cutting Rongeur Forceps
F9-767 25 cm, 10"



Ruskin Bone Cutting Rongeur Forceps
F9-768 20 cm, 8"
Double-Action



BONE CUTTING FORCEPS

Knochensplitterzangen
Pinzas coupantes a os

Pinzas cortantes para huesos
Cesoie per ossa

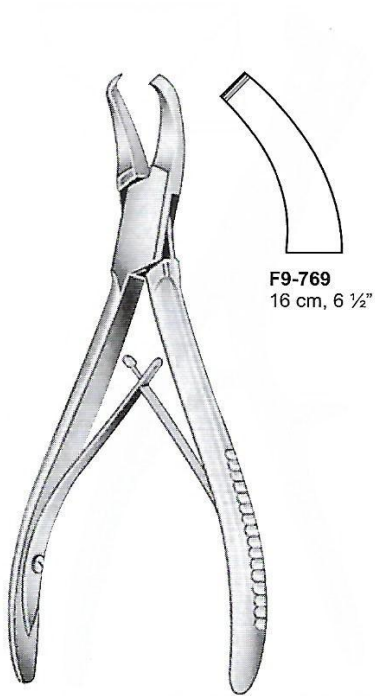

Cleveland-Gardner Bone Cutting Rongeur Forceps

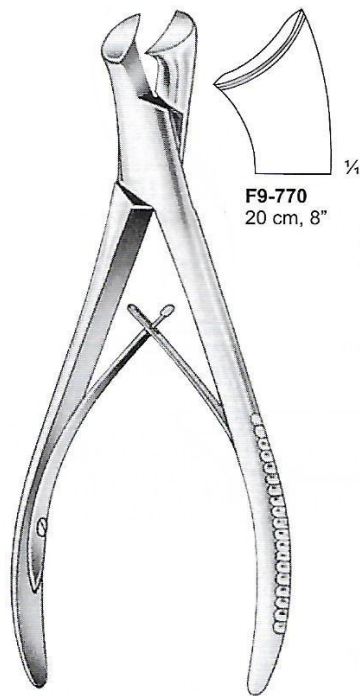

Markwalder Bone Cutting Rongeur Forceps

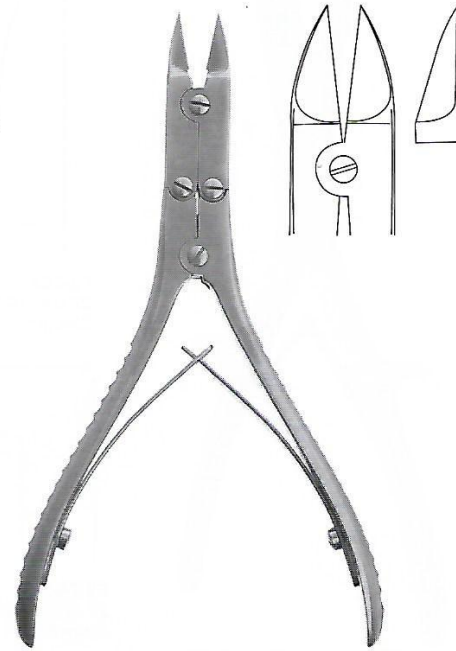

Bone Cutting Rongeur Forceps F9-771
15 cm, 5 3/4"

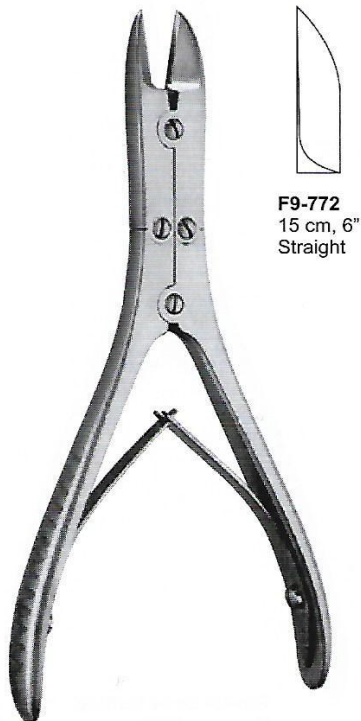

Bohler Bone Cutting Rongeur Forceps

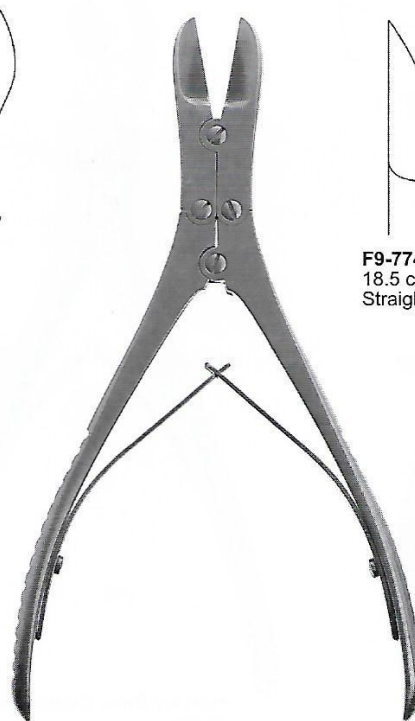
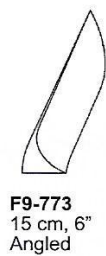

Ruskin-Liston Bone Cutting Rongeur Forceps

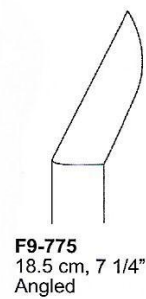
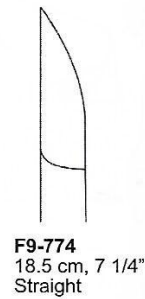

BONE CUTTING FORCEPS



Knochensplitterzangen
Pinces coupantes a os

Pinzas cortantes para huesos
Cesoie per ossa



Walton-Liston Bone Cutting Rongeur Forceps



F9-776
15 cm, 6"
Straight



F9-777
15 cm, 6"
Angled

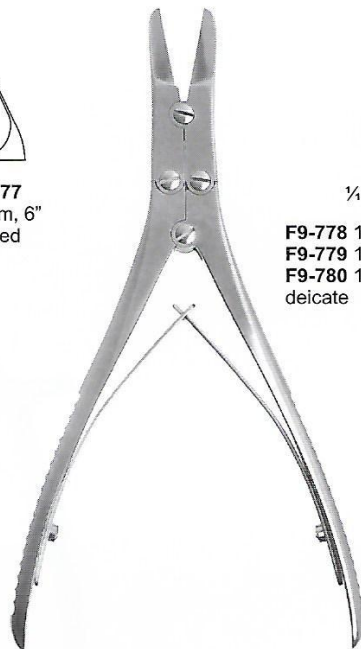

Ruskin-Liston Bone Cutting Rongeur Forceps



F9-778 19 cm, 7 1/2" Straight
F9-779 19 cm, 7 1/2" Curved
F9-780 19 cm, 7 1/2" Angled delicate

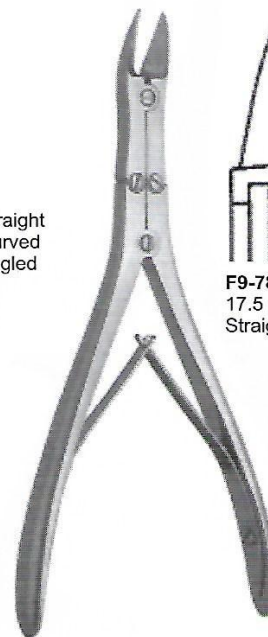

Mc Indoe Bone Cutting Rongeur Forceps



F9-781
17.5 cm, 7"
Straight



F9-782
17.5 cm, 7"
Curved

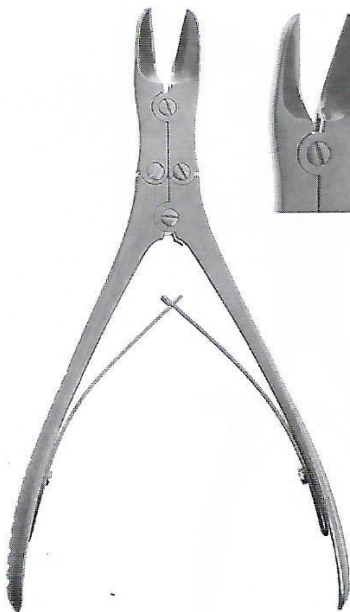

Mc Indoe Bone Cutting Forceps
F9-783 18 cm 7"
Angled, delicate,



Kleinert-Kutz Bone Cutting Forceps
F9-784 15 cm 5 5/8"
Straight, delicate,

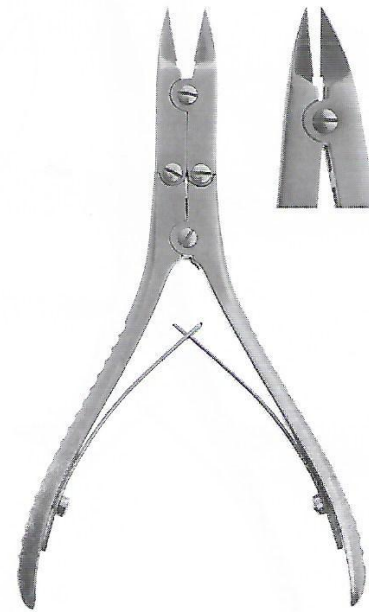

Kleinert-Kutz Synovectomy Rongeur
F9-785 15cm 6" 2 x 10mm
Double action,
Curved on side, delicate,

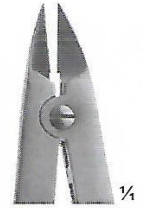



BONE CUTTING FORCEPS

Knochensplitterzangen
Pinces coupantes a os

Pinzas cortantes para huesos
Cesoie per ossa



F9-786
27 cm, 10 1/2"
Straight

Stille-Liston Bone Cutting Rongeur Forceps

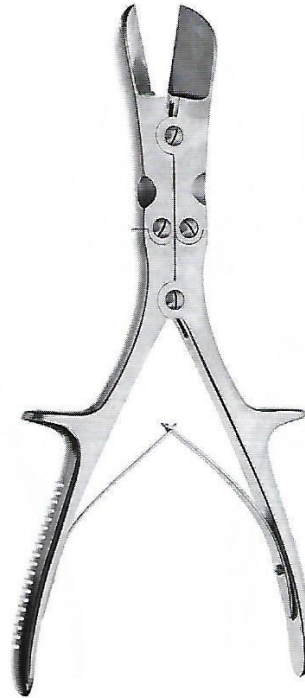

Stille-Horsley Bone Cutting Forceps
F9-787 24 cm 9 3/8"

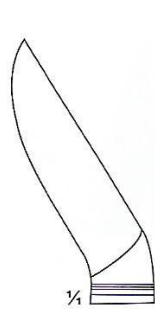

F9-788
23 cm, 9"
Angled

Liston Bone Cutting Rongeur Forceps

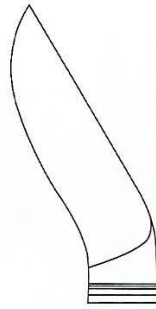

F9-789
27 cm, 10 1/2"
Angled

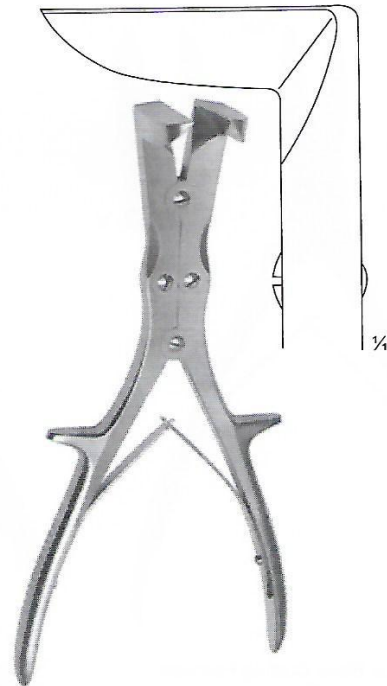

Liston-Stille Bone Cutting Rongeur Forceps
F9-790 26 cm, 10 1/4"

WIRE CUTTING INSTRUMENTS

Drahtschneidezangen
Pinces coupantes

Alicates para cortar alambre
Pinze taglia Filo

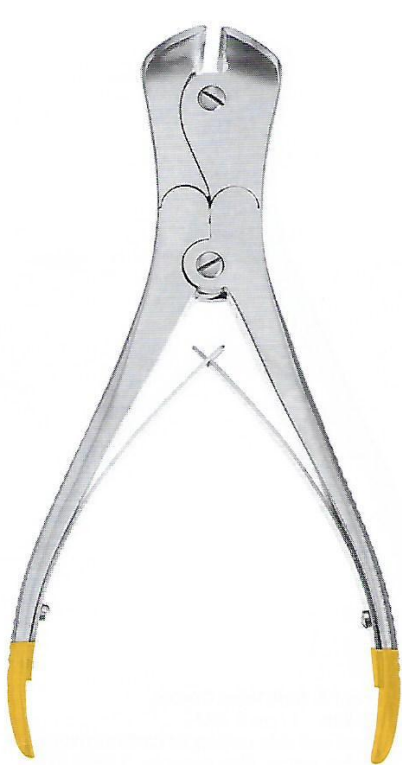

Vital Wire Cutter
F9-791 22cm 8 3/4"
for hard wires up to 2.2mm,
for soft wires up to 3mm



Vital Wire Cutter
F9-792 22cm 8 3/4"
for hard wires up to 2.2mm,
for soft wires up to 2.8mm



Vital Wire Cutter
F9-793 23cm 9"
for hard wires up to 2.2mm,
for soft wires up to 3mm



Vital Wire Cutter
F9-794 18cm 7"
for hard wires up to 1.5mm,
for soft wires up to 2mm



Vital Wire Cutter
F9-795 18cm 7"
for hard wires up to 1.7mm,
for soft wires up to 2mm



Vital Wire Cutter
F9-796 15cm 6"
for hard wires up to 1mm,
for soft wires up to 1.5mm



Vital Wire Cutter
F9-797 14.5cm 5 3/4"
for hard wires up to 1mm,
for soft wires up to 1mm



WIRE CUTTING INSTRUMENTS

Drahtschneidezangen
Pinces coupantes

Alicates para cortar alambre
Pinze taglia Filo



Side Cutter
F9-798 18.5cm 7 1/4"
Welded carbide jaws
max capacity. 1.6mm 062"



Delicate Wire Cutter
F9-799 12.5cm 4 7/8"
Side cutting w/ carbide inserts
max capacity. 0.7mm 028"



Front & Side Wire Cutter
F9-800 17cm 6 3/4"
Front and side cutting w/ carbide inserts,
double action. Max capacity. 1.6mm 062"



Double Action Wire Cutter
Angled, Side cutting w/ carbide inserts
F9-801 17cm 6 5/8"
max cap 1.6mm 062"
F9-802 21.5cm 8 1/2"
max cap. 2.4mm 3/32"



Flush Wire Cutter
F9-803 17cm 6 3/4"
Front and side cutting w/ carbide inserts,
double action. Max capacity. 1.5mm 059"



Wire Forceps
F9-804 17 cm 6 1/2"
Straight, serrated 5.4 mm tip

WIRE CUTTING INSTRUMENTS



Drahtschneidezangen
Pinces coupantes

Alicates para cortar alambre
Pinze taglia Filo



Stille Plaster Shear
F9-805
37cm 14 1/2" 9" to 15"



Schumacher Sternum Shears
F9-806 21cm 8 1/4"



Kirschner Wires & Steinmann Pins Cutter
F9-807 57cm 22 1/2"
up to 6mm



Cannulated Wire / Pin Cutter
F9-808 19 cm 7 1/2"
Cuttis wire upto 1.6 mm



Hard Wire Cutter Cuts
F9-809 26.0cm 10 1/4"
for hard wires up to 3mm



Side Pin Cutter
F9-810 57.5cm 22 5/8"
Side cutting w/ carbide inserts
max. cap: 5/32"



WIRE CUTTING INSTRUMENTS

Drahtschneidezangen
Pinces coupantes

Alicates para cortar alambre
Pinze taglia Filo



Pin Cutter Small
F9-811 26cm 10 1/4"
Max cap: 3.2mm



Pin Cutter Medium
F9-812 36.5cm 14 3/8"
Max cap: 4.7mm,



Large Pin Cutter
F9-813 57.5cm 22 5/8"
Large, Straight, Max.
capacity 6.3mm 1/4"

BONE HOLDING CLAMPS - BONE HOLDING FORCEPS



Knochenhalteklammern - Knochenhaltezangen | *Pinzas porta huesos - Pinzas para huesos*
Daviers a os - Daviers porte-so | *Tenaglie per ossa*



Gerster-Lowmann Bone Clamp

F9-814 12.1cm, 4.75"
F9-815 14.5cm 5 5/8"
F9-816 18cm, 7", 28mm
F9-817 20cm, 8", 35mm
F9-818 22cm, 8 3/4", 40mm
 1x2 Jaws

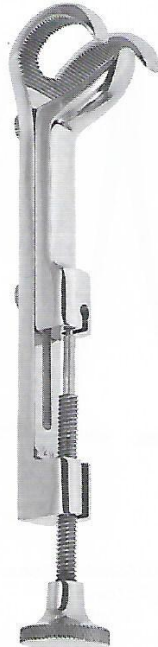

Lowmann Bone Clamp

F9-818A 12cm
F9-818B 15cm
F9-818C 17cm
F9-818D 18.5cm
F9-818E 20cm



Lambert-Lowman Bone Clamp

F9-819 17.5 cm, 7"
F9-820 20.3 cm, 8"
 2x2 Jaws

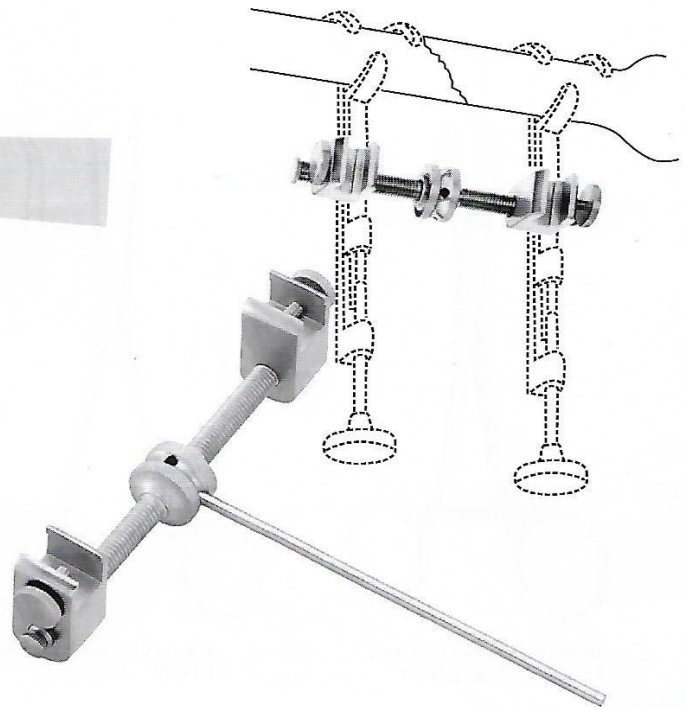

Gerster Bone Holding Clamp

F9-821 15cm, 6"

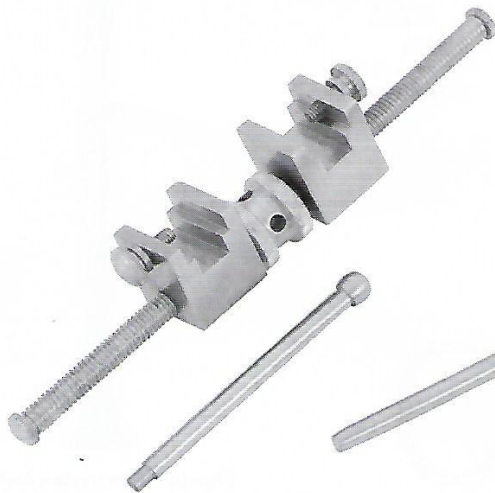

Gerster Bone Holding Clamp
F9-822



Gerster Bone Holding Clamp
F9-823



Parham-Martin Bone Clamp
F9-824
 21cm 8 1/4"
 Straight

Parham Martin Bands
F9-825
 19.0cm 7 1/2"



BONE HOLDING FORCEPS - REPOSITION FORCEPS

Knochenhaltezaugen - Repositionszangen
Daviers porte-so-pinces de reposition

Pinzas para huesos - pinzas para reposicion
Tenaglie per ossa - Pinze per riposizioni



Bone Reduction Forceps
F9-826 13.5cm, 5 1/4"

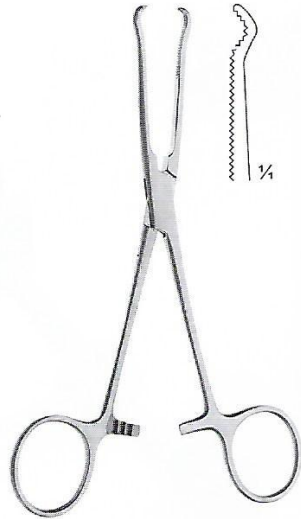

Locke Phalangeal Forceps
F9-827 14cm, 5 1/2"



Lewin Perforating Bone Holding Forceps
F9-828 17.5cm, 7"
serrated



Stagbeetle Bone Reduction Forceps
F9-829
Pointed tips, 13 cm 4 7/8"



F9-830
13.5 cm, 5 1/2"
Angled Serrated

Bone Reduction Orthopedic Forceps

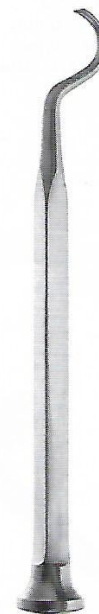

Shoulder Percussion Awl
Pointed, 21.6cm 8 1/2"
F9-831 Small
F9-832 Medium
F9-833 Large
F9-834 Pointed, 23.5cm 9 1/4"

BONE HOLDING FORCEPS



Knochenhaltezaugen
Daviers porte-so

Pinzas para huesos
Tenaglie per ossa



Meniscus Clamp
F9-835 13.5cm 5 3/8"
Serrated



Meniscus Clamp
F9-836 13.5cm 5 3/8"
Angled 20°, serrated



**Preston Logamentum
Flavum Forceps**
F9-837 19 cm 7-1/4"
Curved, 1 x 2 teeth

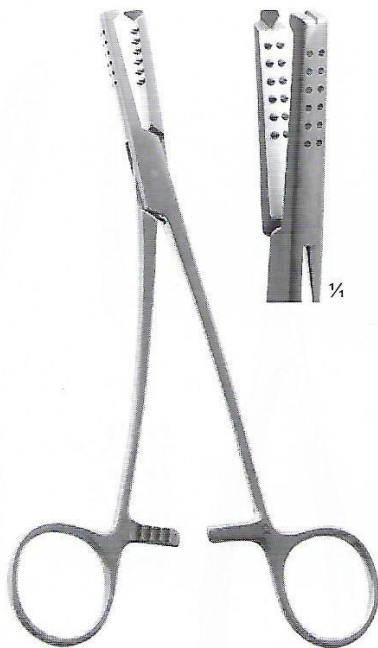

Meniscus Clamp
F9-838 18cm 7 1/8"
Straight, Curved shaft

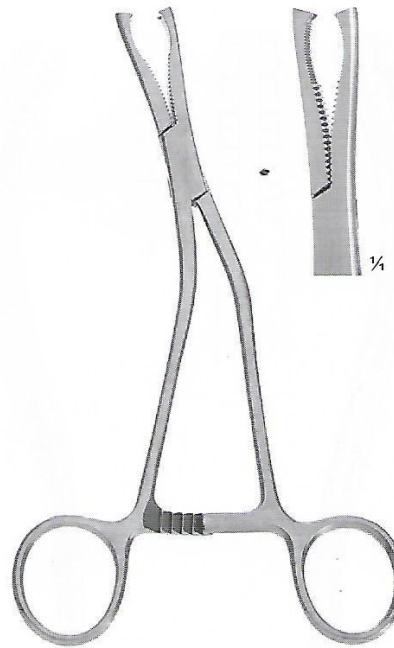

Dingman Bone Clamp
F9-839 19cm 7 1/2"
Straight, Serrated,
1 1/2" tip length,
Curved shaft



BONE HOLDING FORCEPS

Knochenhaltezaugen
Daviers porte-so

Pinzas para huesos
Tenaglie per ossa

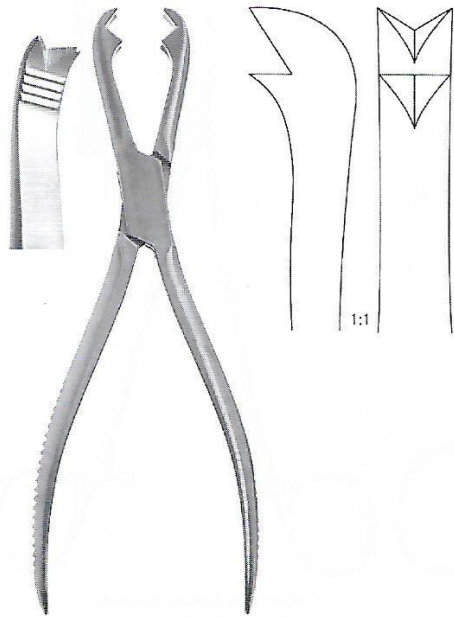

Ferguson Bone Holding Forceps
F9-840 21.0 cm, 8 1/4"
2 x 2 teeth



Van Buren Sequestrum Forceps
F9-841 23.0 cm, 9"
Curved on side, serrated



Langenbeck Bone Holding Forceps
F9-842 21 cm, 8 1/4"

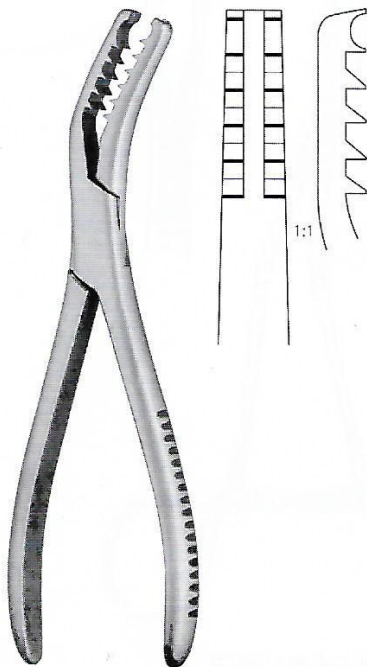

Semb Bone Holding Forceps
F9-843 19 cm, 7 1/2" without ratchet
curved sideways deep teeth

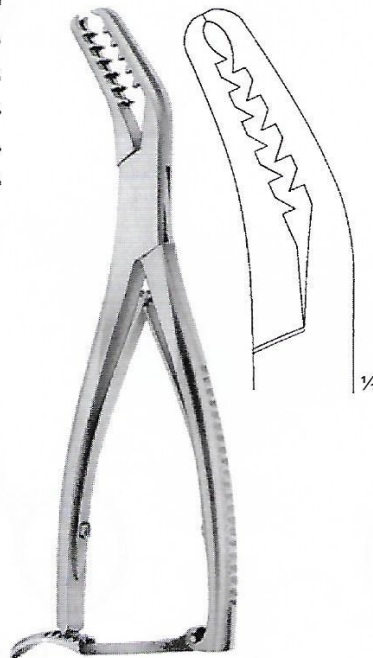

Semb Bone Holding Forceps
F9-844 20.3cm, 8", with ratchet
curved sideways deep teeth

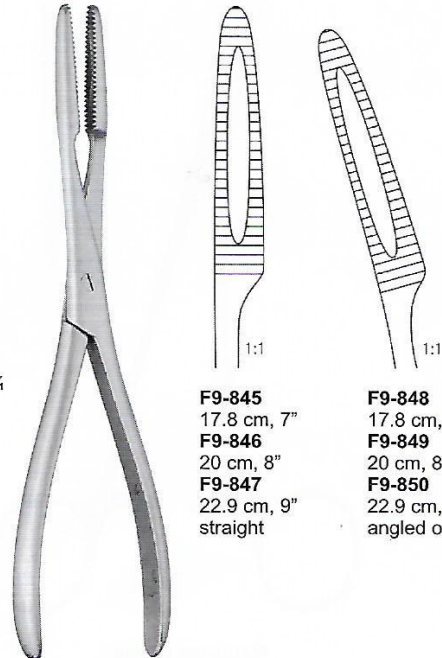

Sequestrum (Nircosis) Bone Holding Forceps

F9-845
17.8 cm, 7"
F9-846
20 cm, 8"
F9-847
22.9 cm, 9"
straight

F9-848
17.8 cm, 7"
F9-849
20 cm, 8"
F9-850
22.9 cm, 9"
angled on flat

BONE HOLDING FORCEPS



Knochenhaltezaugen
Daviers porte-so

Pinzas para huesos
Tenaglie per ossa

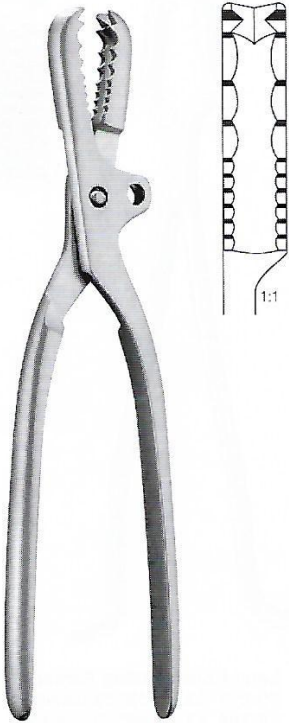

Farabeuf Bone Holding Forceps
F9-851 23 cm, 9"
F9-852 26 cm, 10 1/4"
with adjustable jaw

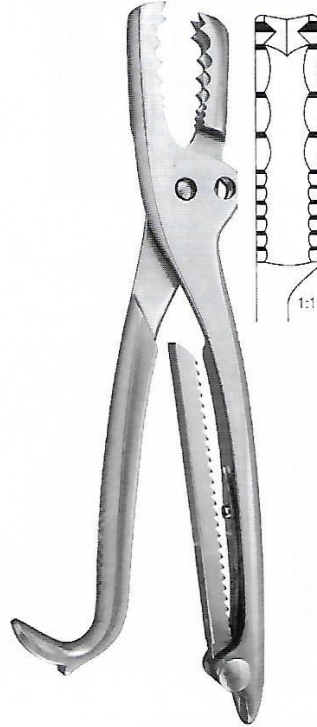

Farabeuf-Lambotte Bone Holding Forceps
F9-853 26 cm, 10 1/4"
with adjustable jaw

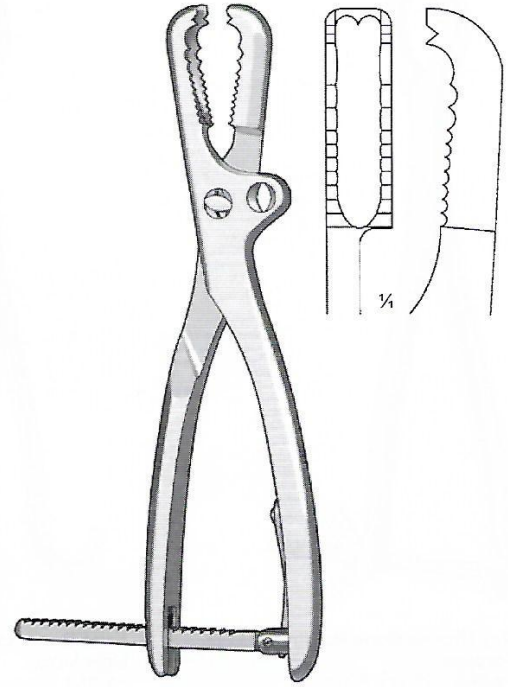

Farabeuf-Lambotte Bone Holding Forceps
F9-854 26 cm, 10 1/4"
with adjustable jaw



Bishop Bone Clamp
F9-855 22.5cm 8 7/8"
Straight



Kern Bone Holding Forceps
F9-856 17 cm, 6 3/4"
F9-857 24 cm, 9 1/2"
without ratchet



Kern Bone Holding Forceps
F9-858 17 cm, 6 3/4"
F9-859 24 cm, 9 1/2"
with ratchet



BONE HOLDING FORCEPS

Knochenhaltezaugen
Daviers porte-so

Pinzas para huesos
Tenaglie per ossa

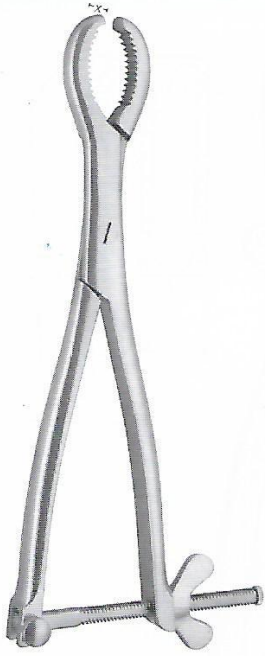

Hey Groves Bone Holding Forceps
F9-860 21 cm, 8 1/4"
F9-861 27 cm, 10 3/4"
F9-862 30. cm, 12"

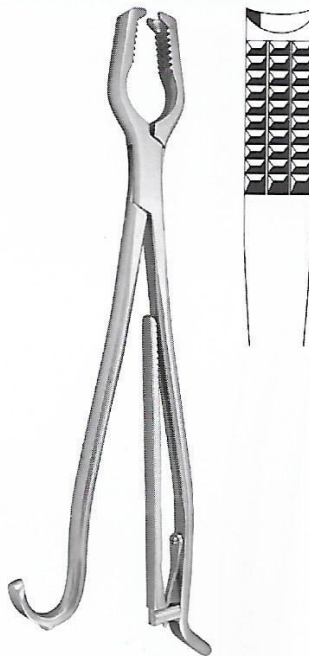

Lane Bone Holding Forceps Light Model
F9-863 33 cm 13" 11 mm tip W/ Ratchet
F9-864 33 cm 13" 13 mm tip W/ Ratchet
F9-865 43 cm 17" 13.5 mm tip W/ Ratchet
F9-866 13 cm 13" 10 mm tip W/o Ratchet



1/4



1:1

Lane Bone Holding Forceps
F9-867 33 cm 13" 13 mm tip
F9-868 43 cm 14" 12 mm tip without ratchet

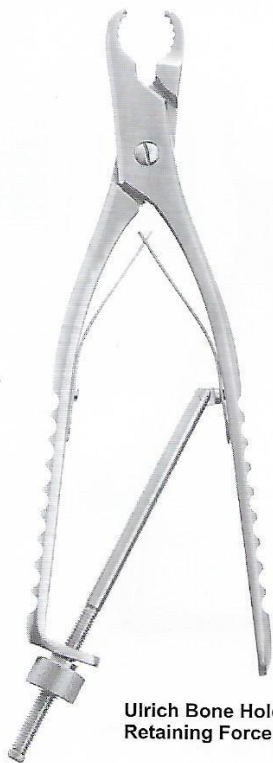

Ulrich Bone Holding Self Retaining Forceps

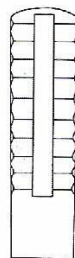

F9-869 18 cm, 7" mini
F9-870 22 cm, 8 1/2"
F9-871 26 cm, 10"
F9-872 28 cm, 11"
Straight with speed lock



Ulrich Bone Holding Forceps



F9-873 18 cm, 7"
F9-874 22 cm, 8 1/2"
F9-875 26 cm, 10"
F9-876 28 cm, 11"
Angular, with speed lock



Ulrich Bone Holding Forceps
F9-877 28 cm 11"
Angular With Speed Lock & swivel jaw

1/4

BONE HOLDING FORCEPS

Knochenhaltezaugen
Daviers porte-so

Pinzas para huesos
Tenaglie per ossa

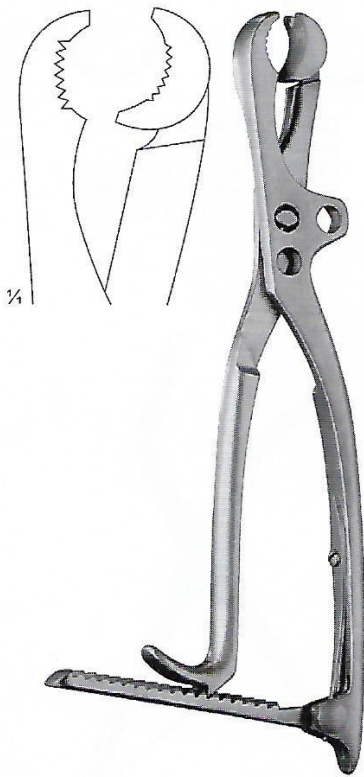

Lambotte Bone Holding Forceps
F9-878 22 cm, 8 3/4"
F9-879 27 cm, 10 3/4"
F9-880 30 cm, 12"
 One Jaw Mobile
 adjustable jaw



Lambotte Bone Holding Forceps
F9-881 15 cm, 6", 2.5mm
F9-882 19 cm, 7 1/2", 6.5mm
F9-883 24 cm, 9 1/2", 9.5mm
F9-884 26 cm, 10 1/4", 10mm
F9-885 28 cm, 11", 11
 Self-Centering, with speed lock

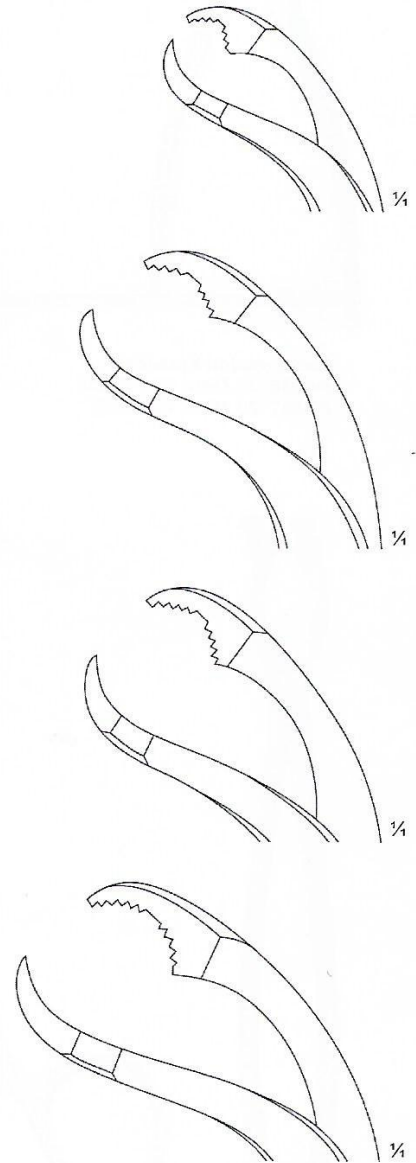



BONE HOLDING FORCEPS

Knochenhaltezen
Daviers porte-so

Pinzas para huesos
Tenaglie per ossa



Subacromion Spreader
F9-886 26.75cm 10.5" Right
F9-887 26.75cm 10.5" Left

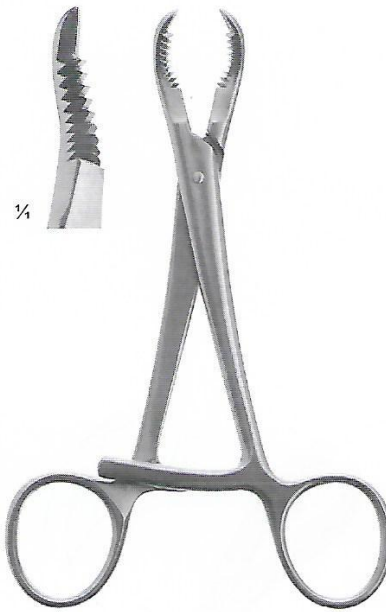

Bone Reduction Forceps
F9-888 14 cm 5 1/2" Curved
F9-889 15 cm 6" Serrated



Bone Reduction Forceps, Pointed Tips
F9-890 14 cm 5 1/2" Serrated
F9-891 14 cm 5 1/4" Curved
F9-892 17 cm 6 3/4" Curved



Lane Bone Holding Forceps
F9-893 31.5 cm
F9-894 39 cm



Bone Reduction Forceps
F9-895 14 cm 5 1/4"
Serrated with pointed tips



Semb Bone Holding Forceps
Curved on side
F9-896 19 cm 7 1/2" 4 x 5 teeth
F9-897 21 cm 8" 5 x 5 teeth

BONE HOLDING FORCEPS



Knochenhaltezaugen
Daviers porte-os

Pinzas para huesos
Tenaglie per ossa



Martin Cartilage Bone Holding Clamp Forceps
F9-898 19 cm, 7 1/2" Str.

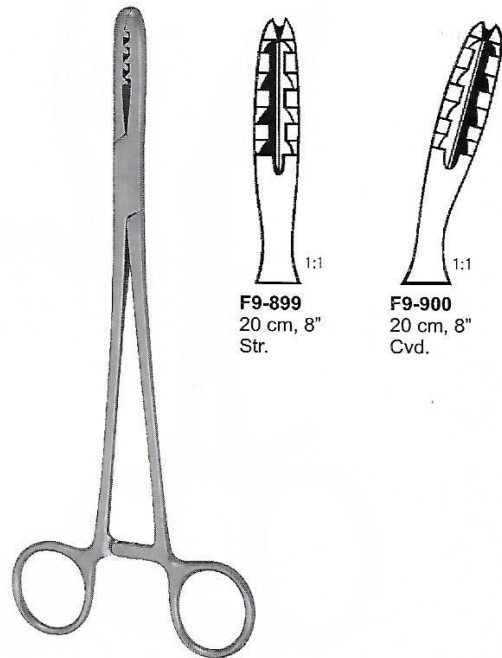

F9-899
20 cm, 8" Str.

F9-900
20 cm, 8" Cvd.

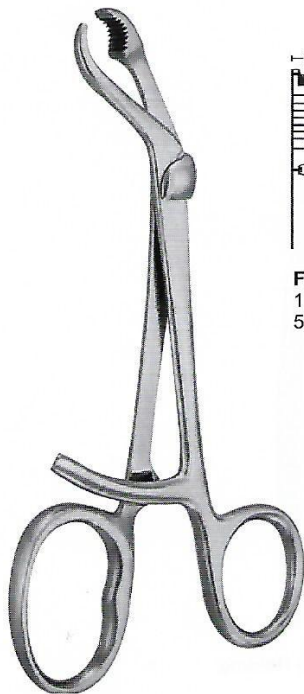

Verbrugge Bone Holding Forceps

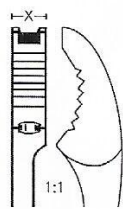

F9-901
17.5 cm, 7" 5.0mm

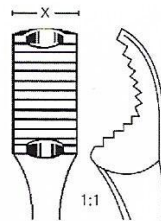

F9-902
25 cm, 10" 9.5mm

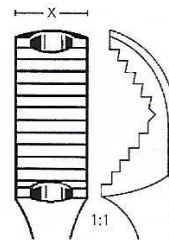

F9-903
26 cm, 10 1/4" 10.5mm

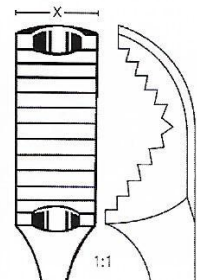

F9-904
27 cm, 10 3/4" 12.0mm



BONE HOLDING FORCEPS

Knochenhaltezaugen
Daviers porte-so

Pinzas para huesos
Tenaglie per ossa

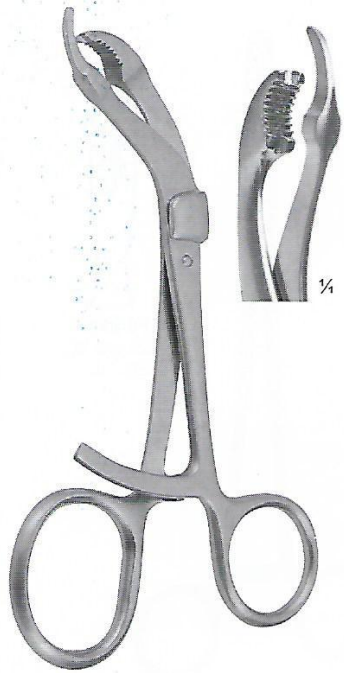

Verbrugge Bone Holding Forceps
F9-905 18 cm 7"
F9-906 26 cm 10"
F9-907 27 cm 10 1/2"
F9-908 28 cm 11"
W/ Long Ratchet



Verbrugge Self-Centering Bone Holding Forceps
F9-909 15 cm 5 3/4"
F9-910 19 cm 7 1/4"
F9-911 24 cm 9 1/4"
F9-912 26 cm 10"
F9-913 29 cm 11 1/4"
with long ratchet

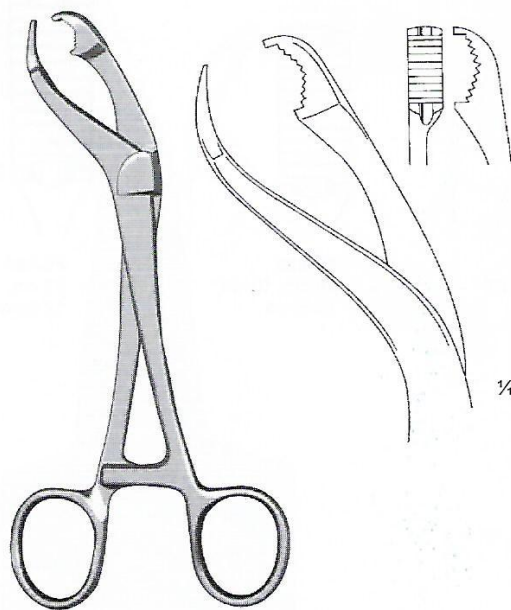

Verbrugge Bone Holding Forceps
F9-914 17.2cm, 6.75"
with short ratchet



Lane Bone Plate Holding Forceps
F9-915 22cm 8 3/4"

BONE HOLDING FORCEPS



Knochenhalte-
zangen
Daviers porte-so

Pinzas para huesos
Tenaglie per ossa

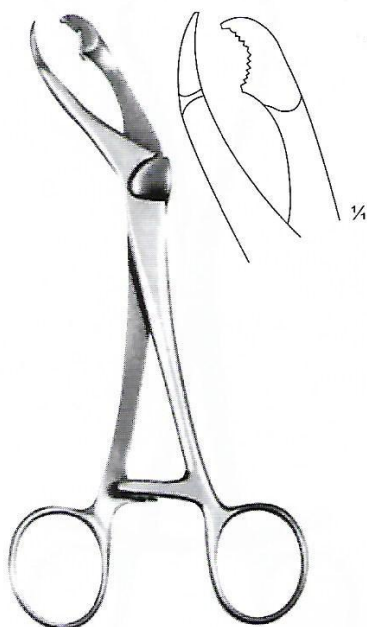

**Verbrugge Bone Holding
Forceps**
F9-916 18 cm, 7"



**Verbrugge Bone Holding
Forceps**
F9-917 18 cm, 7"

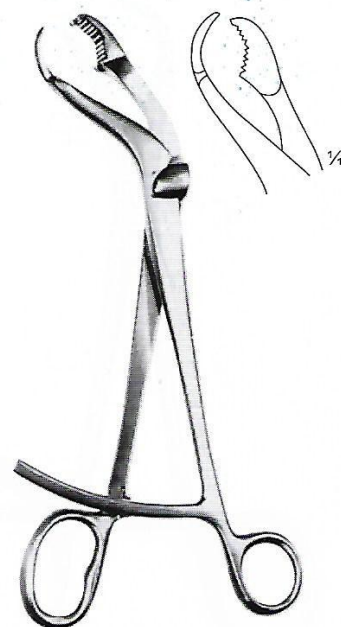

**Verbrugge Bone Holding
Forceps**
F9-918 25 cm, 10"
F9-919 26 cm, 10 1/4"
F9-920 27 cm, 10 1/2"

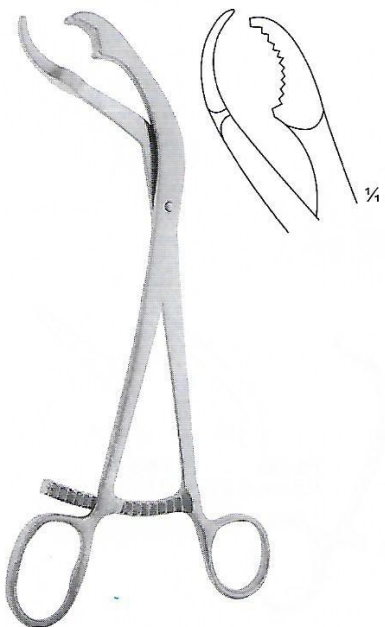

**Verbrugge Bone Holding
Forceps**
F9-921 25 cm, 10"
F9-922 26 cm, 10 1/4"
F9-923 27 cm, 10 1/2"



**Verbrugge Bone Holding
Forceps**
F9-924 18 cm, 7"

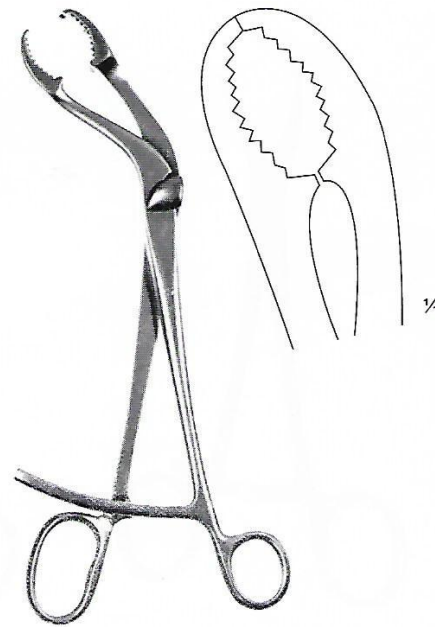

**Verbrugge Bone Holding
Forceps**
F9-925 25 cm, 10"
F9-926 26 cm, 10 1/4"
F9-927 27 cm, 10 1/2"



BONE HOLDING FORCEPS

Knochenhaltezaugen
Daviers porte-so

Pinzas para huesos
Tenaglie per ossa



Bone Reduction Forceps
F9-928 13.5 cm, 5 1/4"



Reill Bone Reduction Forceps
F9-929 17 cm 6 3/4"
Curved, pointed tips

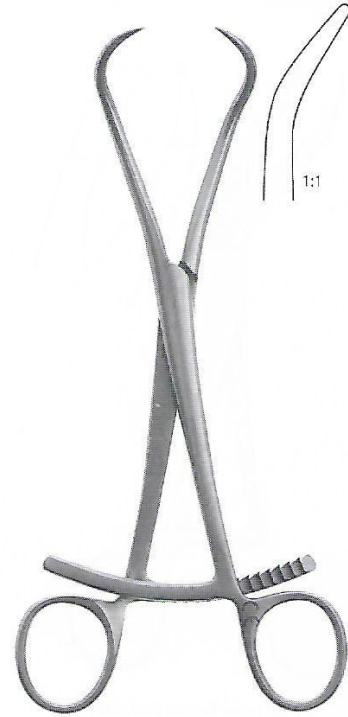

Bone Reduction Forceps
F9-930 20.4 cm, 8"
Pointed tips

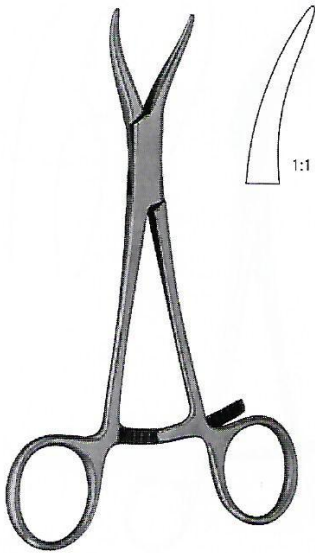

Bone Reduction Forceps
F9-931 13.5 cm, 5"
for maxillary reposition

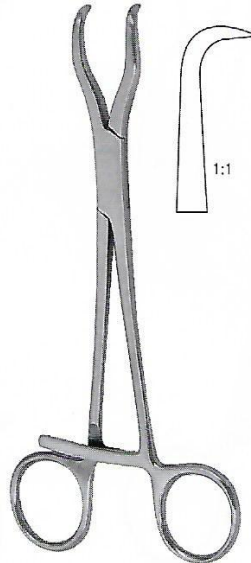

Haase
F9-932
16.5 cm, 6 1/2"
for mandibular
fractures

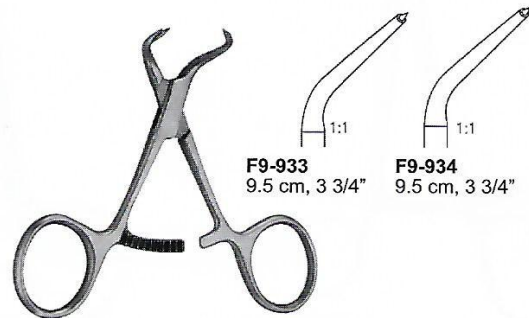

F9-933
9.5 cm, 3 3/4"

F9-934
9.5 cm, 3 3/4"

Bone Holding forceps

BONE HOLDING FORCEPS



Knochenhaltezaugen
Daviers porte-os

Pinzas para huesos
Tenaglie per ossa

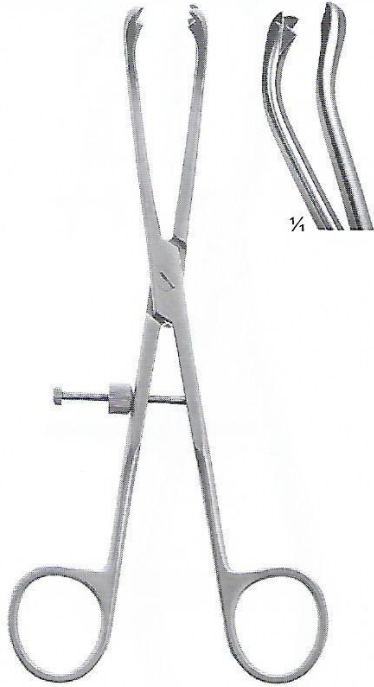

Fibula Bone Holding Forceps
F9-935
22 cm 8 1/2"



Glenoid Perforating Forceps
F9-936 17 cm 6 1/2"
Lightly curved, pointed tips
Strongly curved, pointed tips



Reil Bone Holding Forceps
F9-937 17 cm, 7"



Bone Reduction Forceps
F9-938 20 cm, 8"
with Points



Malleolar Bone Holding Forceps
F9-939 21 cm 8 1/4"
Straight, 1 x 1 teeth



BONE HOLDING FORCEPS

Knochenhaltezaugen
Daviers porte-so

Pinzas para huesos
Tenaglie per ossa



Patella Malleolar Forceps
F9-940 21.0 cm, 8 1/4"

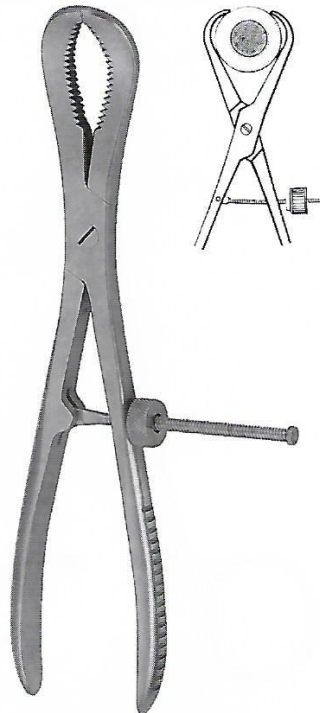

Reduction Forceps
F9-941 16 cm, 6 1/2"
F9-942 24 cm, 9 1/2"
with Thread Lock

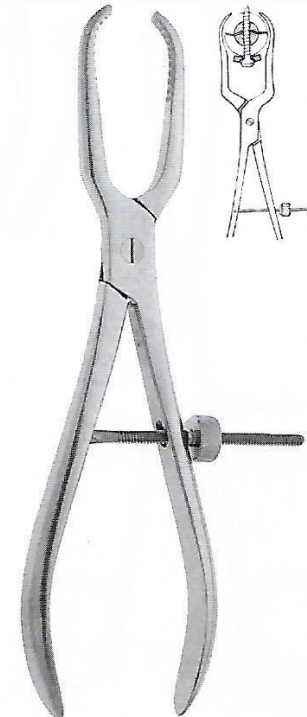

Reposition Forceps
F9-943 23 cm, 9"

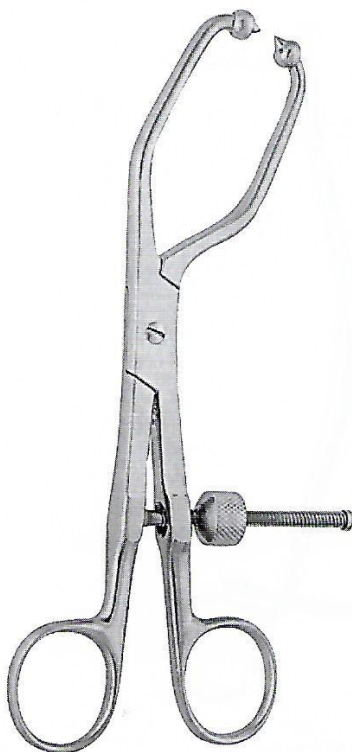

Pelvic Reposition Forceps
F9-944 19 cm, 7 1/2"

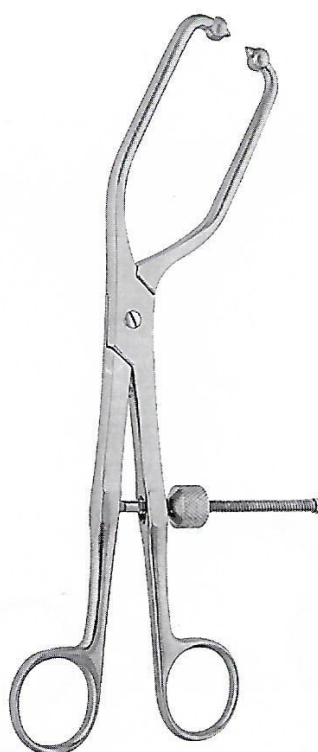

Pelvic Reposition Forceps
F9-945 23 cm, 9"



Pelvic Reposition Forceps
F9-946 25 cm, 10"

BONE HOLDING FORCEPS

Knochenhaltezaugen
Daviers porte-so

Pinzas para huesos
Tenaglie per ossa



Pelvic Reposition Forceps
F9-947 25 cm, 10"
3 Balls Spikes

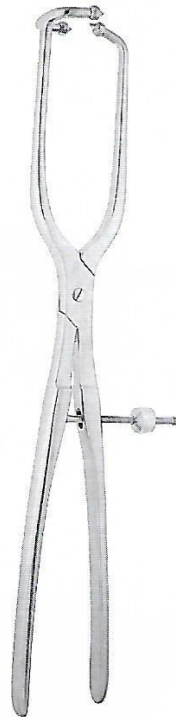

Pelvic Reposition Forceps
F9-948 40 cm, 15 3/4"

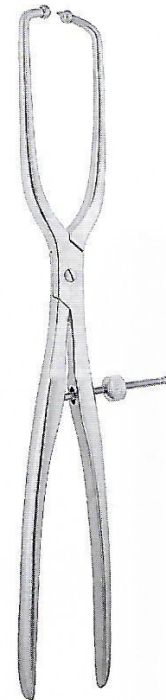

Pelvic Reposition Forceps
F9-949 40 cm, 15 3/4"



Pelvic Reduction Forceps Asymmetric
F9-950 25 cm, 10"
with 3 ball Spikes



Pelvic Reduction Forceps Asymmetric
F9-951 25 cm, 10"

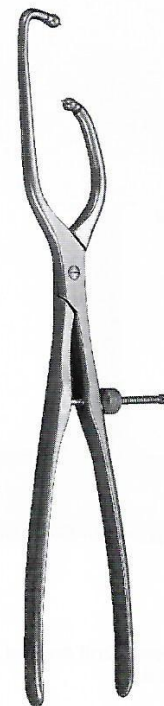

Pelvic Reduction Forceps Asymmetric
F9-952 40 cm, 15 3/4"



HAND DRILLS

Handbohrapparate
Perforateurs a main

Perforadores de mano
Perforatori a mano

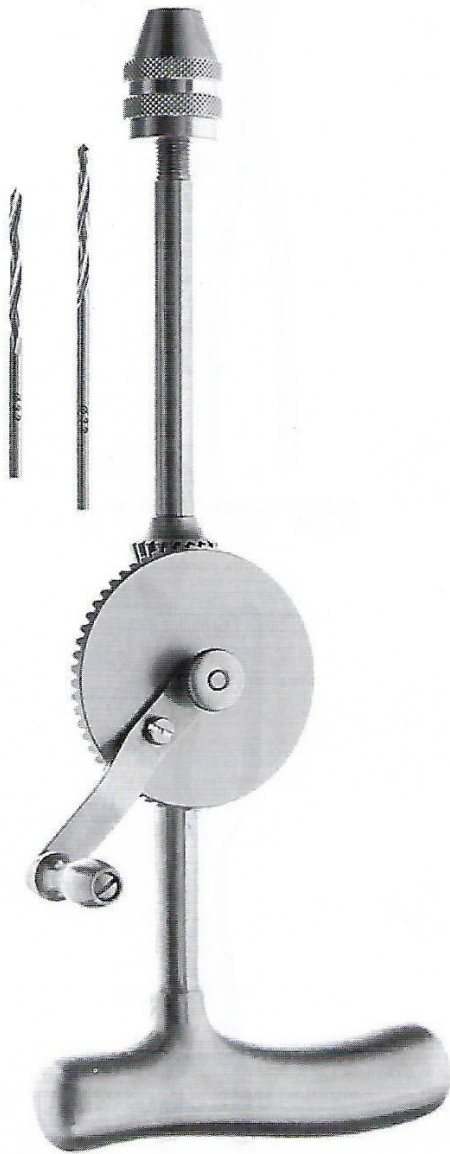

**Moore Drill And Bit Set Complete
F9-953**

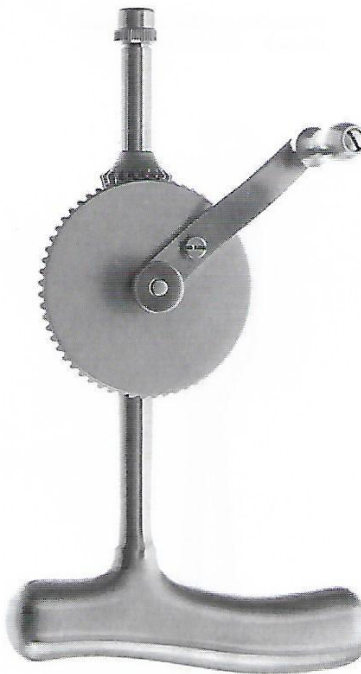

**Stille Pattern Drill Set
F9-954**
Complete set of stainless
drill bits and burs



**Fig. 1
F9-955**
2.5mm



**Fig. 2
F9-956**
3.0mm



**Fig. 3
F9-957**
3.5mm



**Fig. 4
F9-958**
4.0mm



**Fig. 5
F9-959**
5.0mm



**Fig. 6
F9-960**
8.0mm



**Fig. 7
F9-961**
12.0mm



**Fig. 8
F9-962**
16.0mm



**Fig. 09
F9-963**



**Fig. 10
F9-964**
1:2
1.0mm



**Fig. 11
F9-965**
1:2
1.5mm

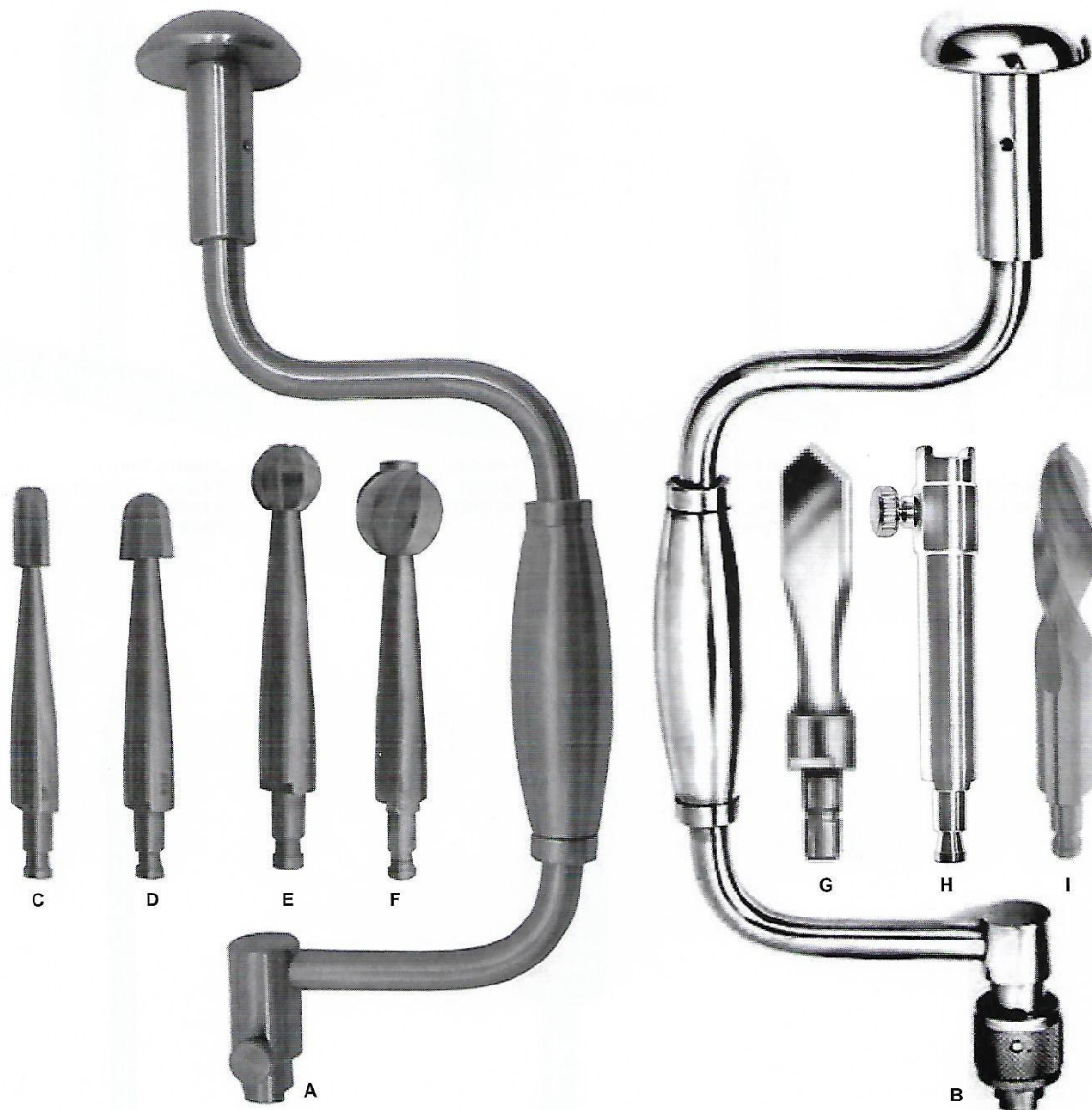

**Fig. 12
F9-966**
1:2
2.0mm

HAND DRILLS

Handbohrapparate
Perforateurs a main

Perforadores de mano
Perforatori a mano



F9-967
Hudson Brace 10 1/2" (26.7cm),
with standard thumb screw chuck

F9-968
Hudson Brace 11" (27.9cm),
with Improved Snap-Lock chuck

- C F9-969 Hudson Bur, 9mm Diameter
- D F9-970 Hudson Bur, 14mm Diameter
- E F9-971 Hudson Bur, 16mm Diameter
- F F9-972 Hudson Bur, 22mm Diameter
- G F9-973 Cushing Perforator, for Hudson Brace
- H F9-974 Hudson Cerabellar Extension, 4" for Hudson Brace
- I F9-975 McKenzie Perforator for Hudson Brace



HAND DRILLS

Handbohrapparate
Perforateurs a main

Perforadores de mano
Perforatori a mano



Jacobs
F9-976 28cm 11"
opening up to 6.35mm



Hand Drill
F9-977
opening up to 6.35mm



T-Handle
F9-978
AO Coupling



Jacob's Chuck
F9-979 T-Handle and key
F9-980 only
F9-981 Key

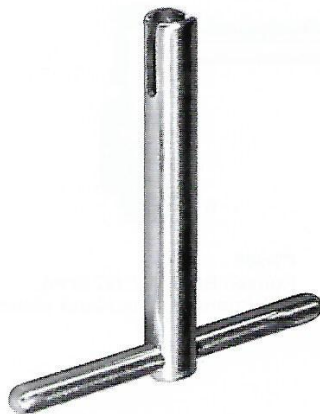

Key Handle
F9-982



T-Handle
F9-983
for AO Coupling

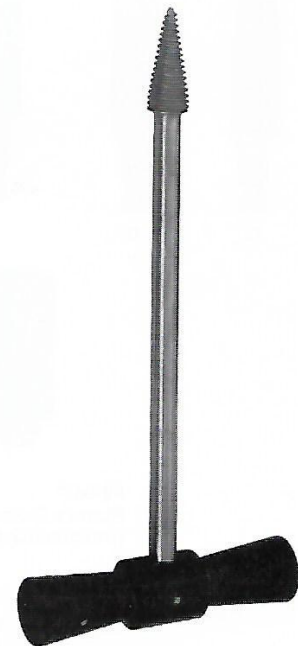

Memoral Head Extrator
F9-984

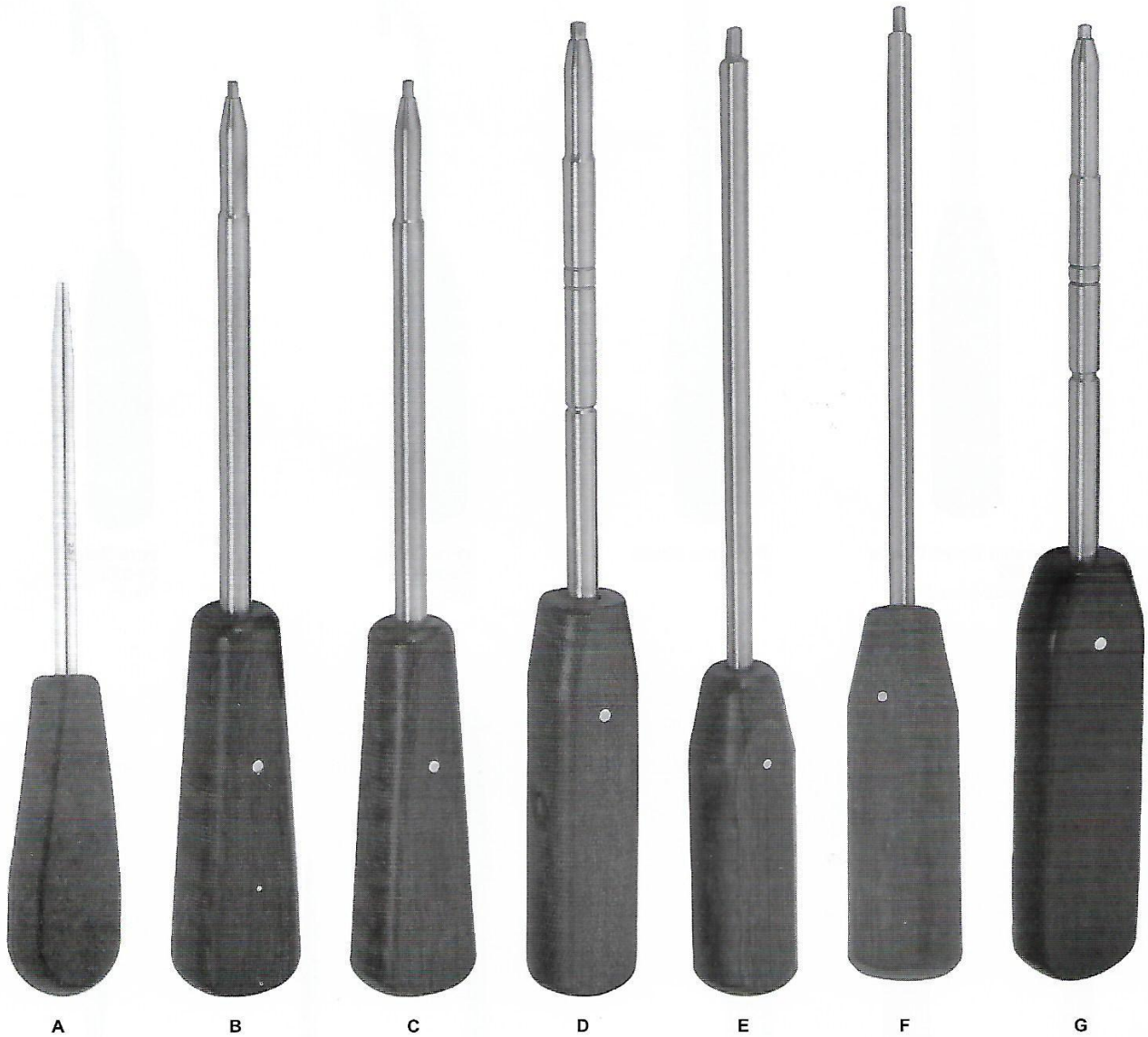

HEXAGONAL HEAD

	Size of screws	Head Size	Fiber-Handle	AO Coupling	Dental Coupling
A	1.5mm	1.5mm	F9-985	F9-988	F9-991
B	2.0mm				
C	2.7mm				
D	3.5mm	2.5mm	F9-986	F9-989	
E	4.0mm				
F	4.5mm	3.5mm	F9-987	F9-990	
G	6.5mm				



TWIST DRILLS - REAMERS - FORCEPS

Spiralbohrer - Pfieme - zangen
Meches - Alenes - Daviers

Taladros espirales - Escariadores - Pinzas
Punte a spirale - Perforatori a mano - Tenaglie



Parallel Target Device
F9-992
for guide wires 2mm



Mortising Chisel
F9-993



Wire Guide
F9-994
45mm



Wire Guide
F9-995
70mm



Countersink
F9-996



Countersink
F9-997



Countersink
F9-998



Perthes
F9-999 18cm 7"
F9-1000 21cm 8 1/4"



F9-1001
14cm 5 1/2"

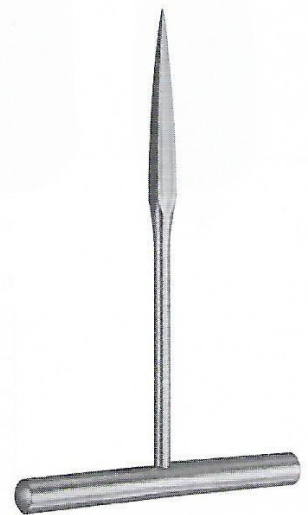

F9-1002
14cm 5 1/2"



Mini Drill Sleeve
F9-1003
 1.1 mm and 1.5 mm drill bits
F9-1004
 1.5 mm and 2.0 mm drill bits

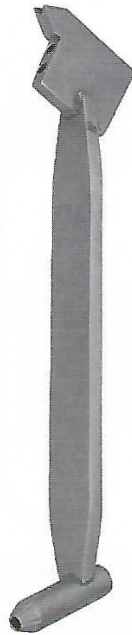

Drill Guide
F9-1005
 drill sleeve for 2.0 mm
 drill bit

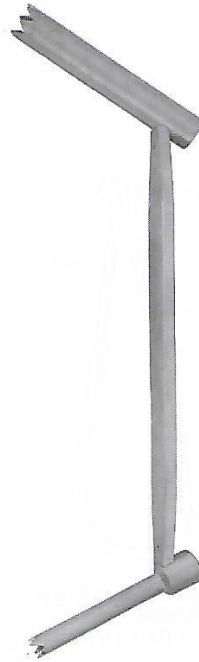

F9-1006 Tap Sleeve, 2.0 mm ϕ
F9-1007 Drill Sleeve, 2.7 mm ϕ
F9-1008 Tap Sleeve, 2.5 mm ϕ
F9-1009 Drill Sleeve, 3.5 mm ϕ



Neutral & Load Drill Guide
F9-1010 1.5 mm for 2.0 mm Screws
F9-1011 2.0 mm for 2.7 mm Screws
F9-1012 2.5 mm for 3.5 mm Screws
F9-1013 3.2 mm for 4.5 mm Screws

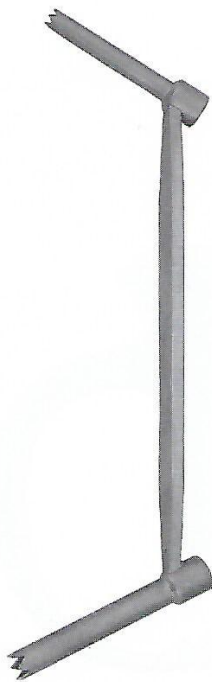

Tap Sleeve
F9-1014
 3.5 mm

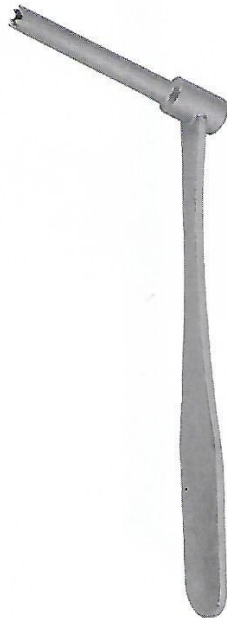

Tap Sleeve
F9-1015
 3.5 mm also for used
 as 3.2 mm drill Guide

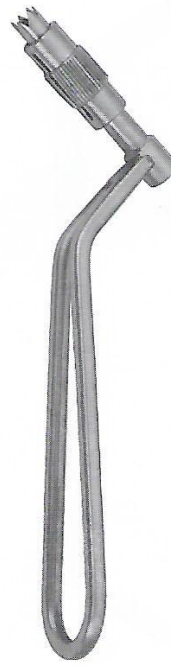

Tap Sleeve
F9-1016
 4.5 mm

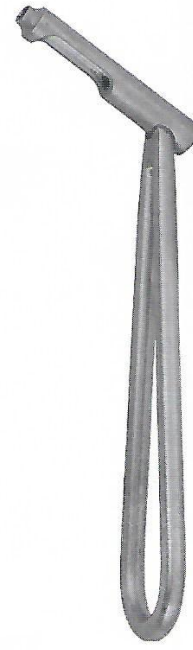

Drill Sleeve
F9-1017
 3.2 mm for Round
 Hole Plates



Insert Drill Sleeve
F9-1018 2.7 / 2.0 mm Drill Bit 2.0 mm
F9-1019 3.5 / 2.5 mm Drill Bit 2.5 mm
F9-1020 4.5 / 3.2 mm Drill Bit 3.2 mm



Drill Small Pointed
F9-1021
Drill Bit 3.5 mm



Drill Pointed Guide
F9-1022
6.5 mm



Drill Pointed Guide
F9-1023
6.5 mm

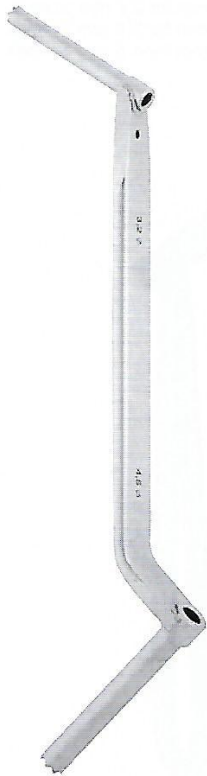

Drill Guide
F9-1024
4.5 mm Screws
Drill Bit 4.5 mm &
3.2 mm

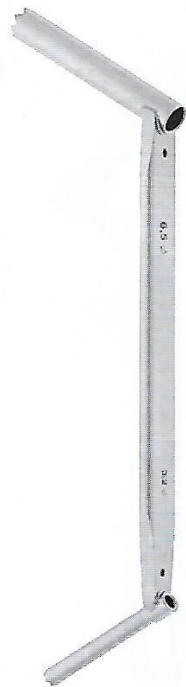

Drill Guide
F9-1025
6.5 mm Screws
Drill Bit 3.2 mm



Drill Guide
F9-1026
3.5 mm for neutral
and compression Positioning
Drill Bit 2.5 mm



C - Clamp
F9-1027
Drill Guide with thread
for Drill Bit 4.5 mm

WIRE INSTRUMENTS



Draht-Instrumentarium
Instruments pour cerclage

Instrumental para cerclaje
Strumenti per filo di cerchiaggio



**Bending Device
F9-1028**
21.5cm 8 1/4"
to bend straight
and angled plates

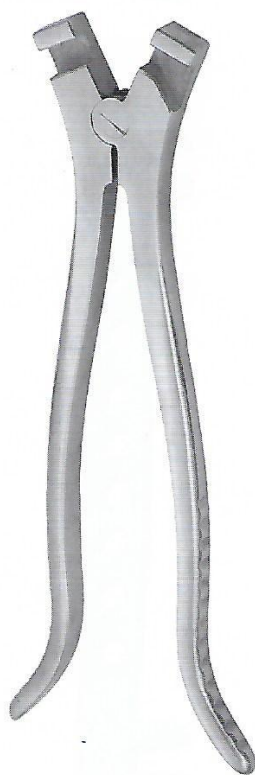

**Rod Bender
F9-1029**
to bend straight
and angled



**Universal Rod Bender
F9-1030**
28.5cm 11 1/4"
to bend straight
and angled



**Rod Bender
F9-1031**
to bend straight
and angled



**Slotted Hammer
F9-1032 14mm**



WIRE INSTRUMENTS

Draht-Instrumentarium
Instruments pour cerclage

Instrumental para cerclaje
Strumenti per filo di cerchiaggio



Plate Bender
F9-1033

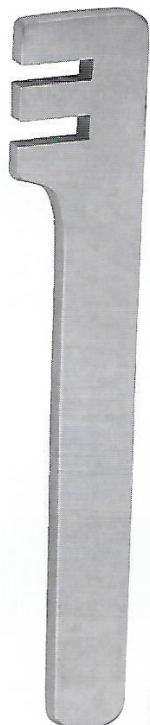

Plate Bender
F9-1034

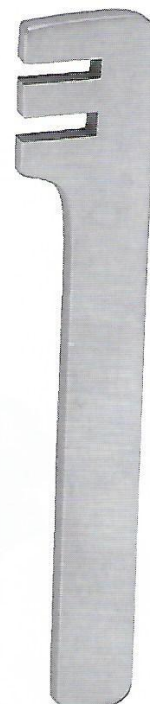

Plate Bender
F9-1035

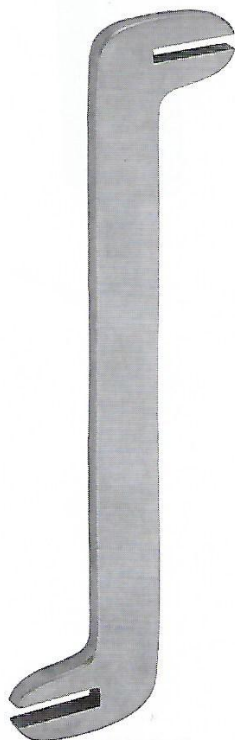

Plate Bender
F9-1036

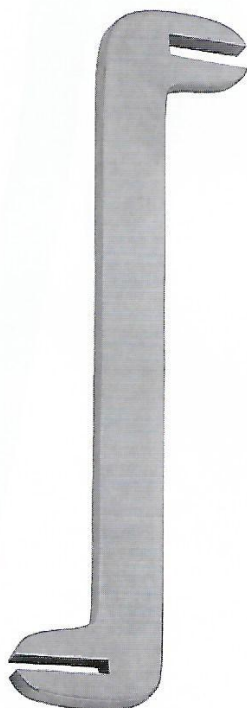

Plate Bender
F9-1037

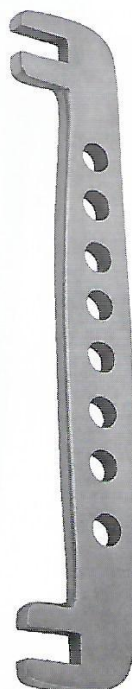

Plate Bender
F9-1038

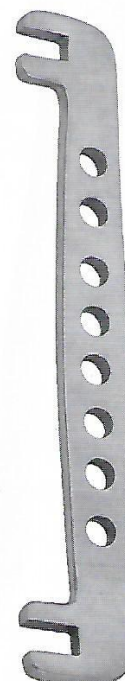

Plate Bender
F9-1039

EXTENSION BOWS

Extensionsbugel
Etriers pour extension

Estribos para extension
Archi per estensione



F9-1040 18cm, 7"
Wire strainer for
kirschner wires

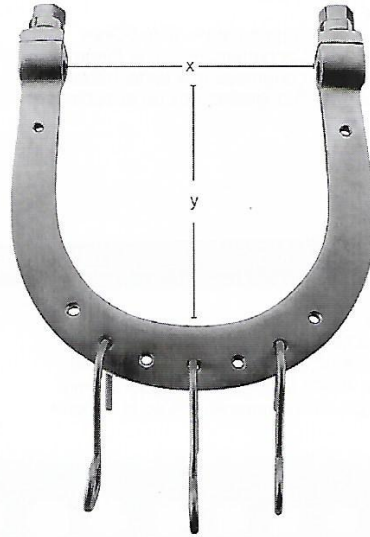

Kirschner Extension Bows
F9-1041 x=95mm y=70mm
F9-1042 x=100mm y=100mm
F9-1043 x=120mm y=120mm
F9-1044 x=155mm y=155mm
F9-1045 x=200mm y=155mm
 with 3 traction hooks

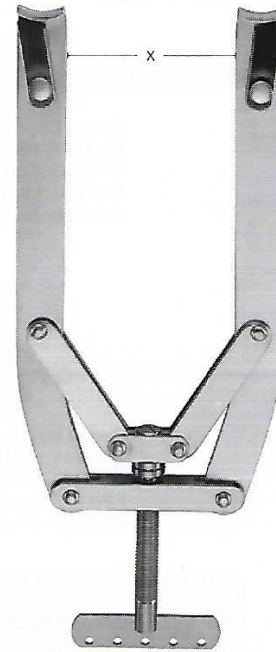

Kirschner Extension Bows
F9-1046 x=130mm
F9-1047 x=185mm
F9-1048 x=220mm
 with 3 traction hooks



Wrench
Kirschner
Extension Bows
F9-1049
 14mm/17mm

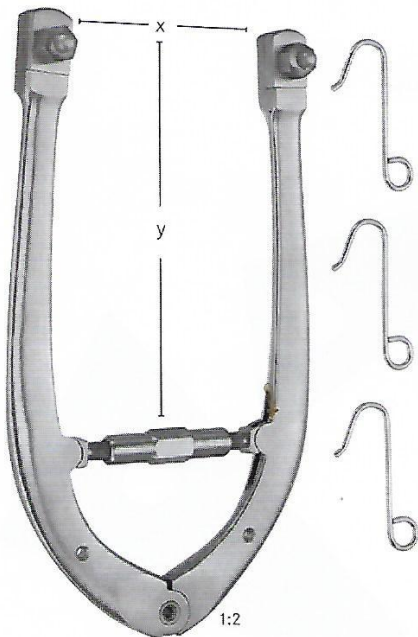

Kirschner Extension Bows
F9-1050 x=180mm y=100mm
F9-1051 x=270mm y=160mm
 with 3 traction hooks

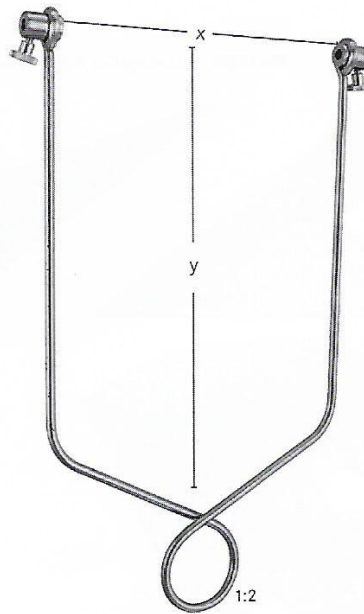

Bohler Kirschner Extension Bows
F9-1052 x=75mm y=90mm
F9-1053 x=90mm y=160mm
F9-1054 x=110mm y=210mm
F9-1055 x=150mm y=210mm
 with 3 traction hooks



Charnley-mueller
F9-1056
 Compression Clamp



ANGLED BLADE PLATE



Screw Depth Gauges

- F9-1057 Mini Gauge, 4 3/4" Long measures up to 30mm
- F9-1058 Small Gauge, 6 1/4" Long measures up to 50mm
- F9-1059 Large Gauge, 8 3/4" Long measures up to 100mm
- F9-1060 X-Large Gauge, 11" Long measures up to 120mm



Screw Depth Gauges

- F9-1061 Mini Gauge, 4 3/4" Long measures up to 30mm
- F9-1062 Small Gauge, 6 1/4" Long measures up to 50mm
- F9-1063 Large Gauge, 8 3/4" Long measures up to 100mm
- F9-1064 X-Large Gauge, 11" Long measures up to 120mm

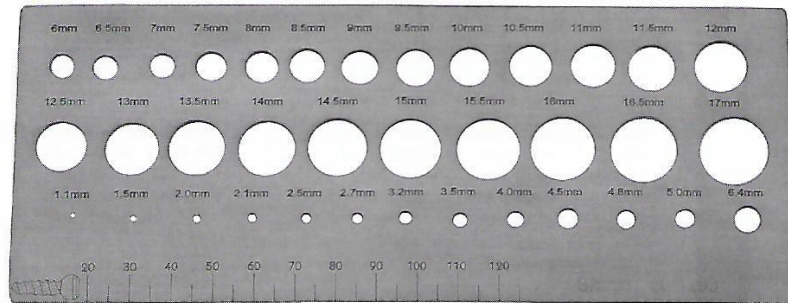

Measuring Gauge
F9-1065
for nail

F9-1066 Tri Angular Positioning Plate

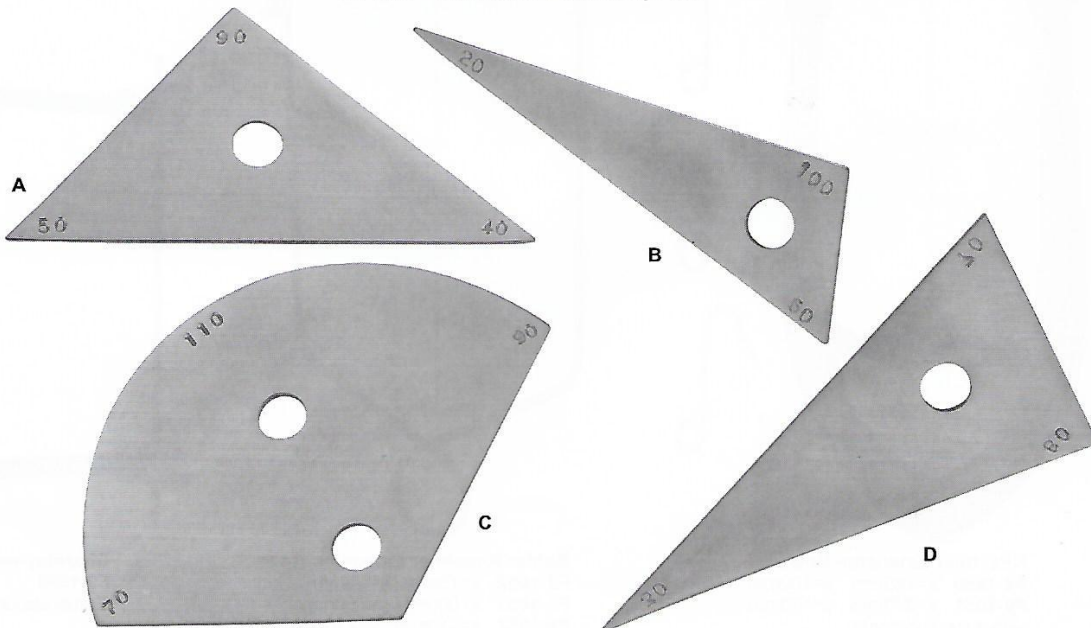



ENT Surgery

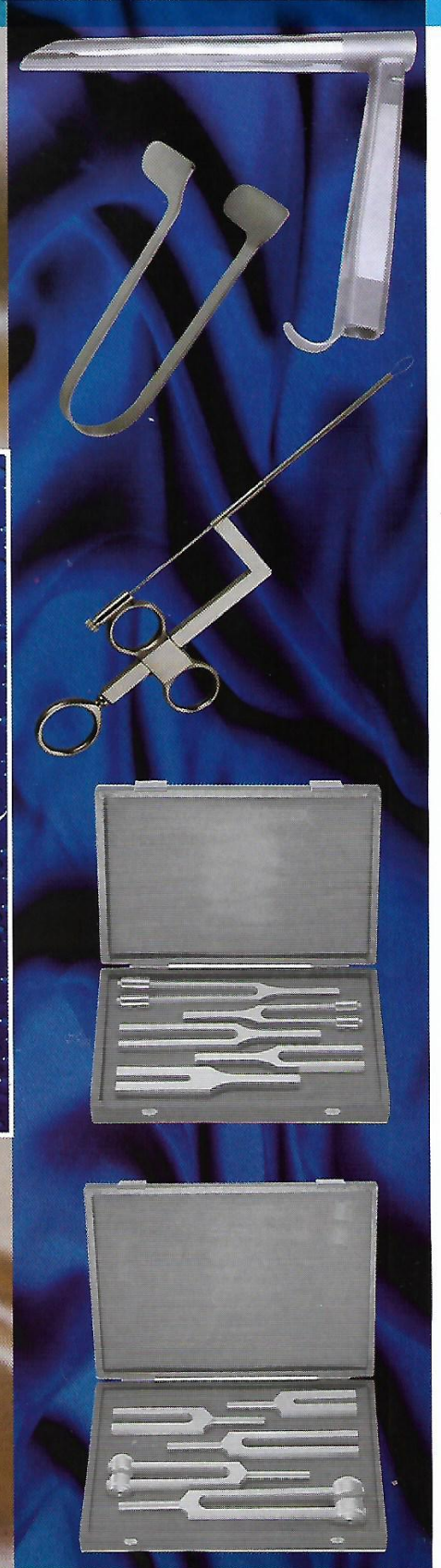
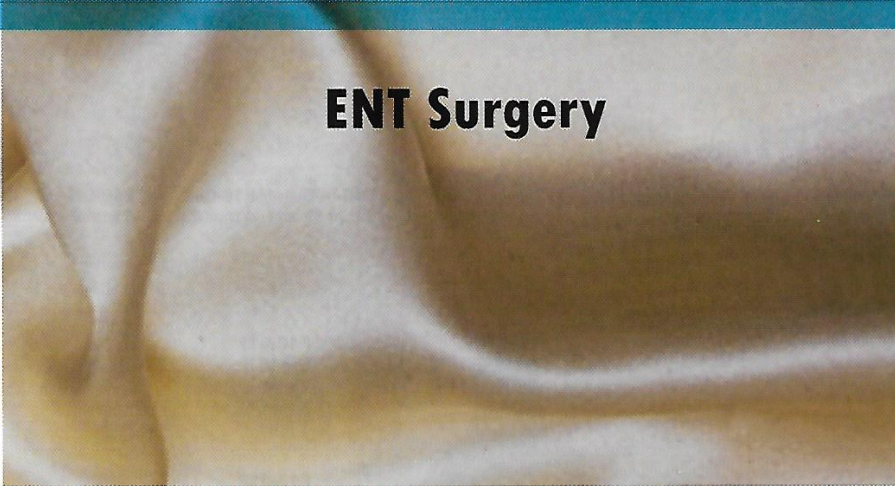



EAR SPECULUM

Ohrspekula
Speculums auriculaires

Espéculos auriculares
Spécoli auricolari

- **F10-001**
4.5 mm Ø
- **F10-002**
5.5 mm Ø
- **F10-003**
6.5 mm Ø
- **F10-004**
7.5 mm Ø

- **F10-007**
2 mm Ø
- **F10-008**
3 mm Ø
- **F10-009**
4 mm Ø
- **F10-010**
5 mm Ø



Toynbee Ear Speculum
3.6 cm 1 1/2"
Set for adults

F10-005
Set of 3
5.5 mm
6.5 mm
7.5 mm

F10-006
Set of 4
4.5 mm
5.5 mm
6.5 mm
7.5 mm



Poltzer Ear Speculum
Set for adults

F10-011
Set of 3
2 mm
3 mm
4 mm

F10-012
Set of 4
2 mm
3 mm
4 mm
5 mm



Gruber Ear Speculum
Set for adults

○
F10-013
a - 4.5 mm Ø

○
F10-014
a - 5.5 mm Ø

○
F10-015
a - 6.5 mm Ø

○
a
F10-016
a - 7.5 mm Ø

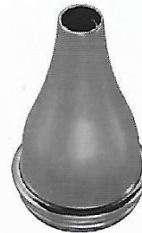

Gruber Ear Speculum
Set for adults

○
F10-017
a - 4.5 mm Ø

○
F10-018
a - 5.5 mm Ø

○
F10-019
a - 6.5 mm Ø

○
F10-020
a - 7.5 mm Ø



Boucheron Ear Speculum
Set for adults

- **F10-021**
4.5 mm Ø
- **F10-022**
5.5 mm Ø
- **F10-023**
6.5 mm Ø
- **F10-024**
7.5 mm Ø

- **F10-025**
3 mm Ø
- **F10-026**
4.5 mm Ø
- **F10-027**
5.5 mm Ø



Boucheron Ear Speculum
Set for children

TUNING FORKS



Stimmgabeln | Diapasones
Diapasons | Diapasoni

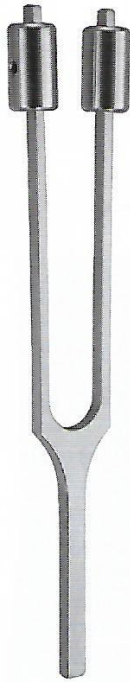

**Hartmann
Tuning Fork
F10-028**
C 64

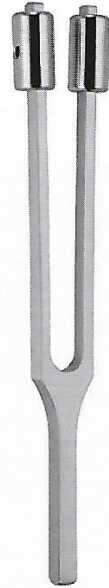

**Hartmann
Tuning Fork
F10-029**
c 128

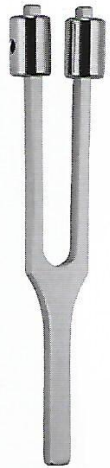

**Hartmann
Tuning Fork
F10-030**
c1 256



**Hartmann tuning
fork with or without
plastic base a1 440**
F10-031
a1 440



**Tuning Forks neuroi
with hammer**
F10-032

NOISE DRUM

Lärmtrommel | Aparato
Assourdisseur | Assordatore



Barany Noise Drum
F10-033



**Lucae
Tuning Fork
F10-034**
c 128
Variable up to h (ehn, b)

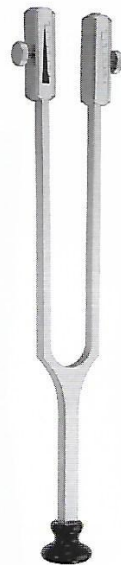

**Rydel-Seiffer
Tuning Fork
F10-035**
C 64 / c 128
With clamps C 64,
Without clamps c 128

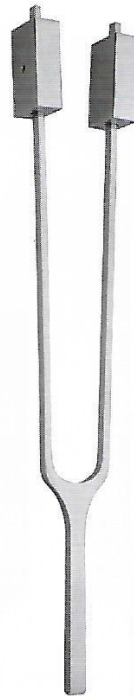

**French
Tuning Fork
F10-036**
C2 16

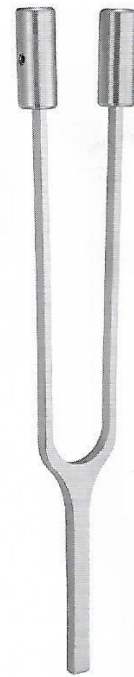

**French
Tuning Fork
F10-037**
C1 32



TUNING FORKS

Stimmgabeln | Diapasones
Diapasons | Diapasoni



F10-038
c 128



F10-039
c1 256



F10-040
c2 512



F10-041
c3 1024



F10-042
c4 2048



F10-043
c5 4096

Hartmann Tuning Fork



F10-044
Hartmann tuning Forks Set case/5

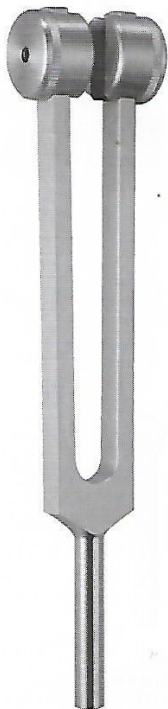

F10-045
c 128

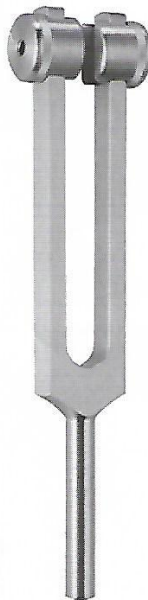

F10-046
c1 256



F10-047
c2 512



F10-048
c3 1024



F10-049
c4 2048



F10-050
TUNING FORKS Set in case of 5

EAR CURETTES



Ohrküretten

Curetas auriculares

Curettes auriculaires

Curette auricolari

<p>Buck, Ear Curette</p>	<p>F10-051 16.5 cm 6 1/2" Blunt</p>	<p>F10-052 16.5 cm 6 1/2" Blunt</p>	<p>F10-053 16.5 cm 6 1/2" Blunt</p>	<p>F10-054 16.5 cm 6 1/2" Blunt</p>	<p>F10-055 16.5 cm 6 1/2" Blunt</p>	<p>F10-056 16.5 cm 6 1/2" Blunt</p>	<p>F10-057 16.5 cm 6 1/2" Blunt</p>	<p>F10-058 16.5 cm 6 1/2" Blunt</p>
	<p>F10-059 16.5 cm 6 1/2" Sharp</p>	<p>F10-060 16.5 cm 6 1/2" Sharp</p>	<p>F10-061 16.5 cm 6 1/2" Sharp</p>	<p>F10-062 16.5 cm 6 1/2" Sharp</p>	<p>F10-063 16.5 cm 6 1/2" Sharp</p>	<p>F10-064 16.5 cm 6 1/2" Sharp</p>	<p>F10-065 16.5 cm 6 1/2" Sharp</p>	<p>F10-066 16.5 cm 6 1/2" Sharp</p>
	<p>F10-067 16.5 cm 6 1/2" Curved, Blunt</p>	<p>F10-068 16.5 cm 6 1/2" Curved, Blunt</p>	<p>F10-069 16.5 cm 6 1/2" Curved, Blunt</p>	<p>F10-070 16.5 cm 6 1/2" Curved, Blunt</p>	<p>F10-071 16.5 cm 6 1/2" Curved, Blunt</p>	<p>F10-072 16.5 cm 6 1/2" Curved, Blunt</p>	<p>F10-073 16.5 cm 6 1/2" Curved, Blunt</p>	<p>F10-074 16.5 cm 6 1/2" Curved, Blunt</p>
	<p>F10-075 16.5 cm 6 1/2" Curved, Sharp</p>	<p>F10-076 16.5 cm 6 1/2" Curved, Sharp</p>	<p>F10-077 16.5 cm 6 1/2" Curved, Sharp</p>	<p>F10-078 16.5 cm 6 1/2" Curved, Sharp</p>	<p>F10-079 16.5 cm 6 1/2" Curved, Sharp</p>	<p>F10-080 16.5 cm 6 1/2" Curved, Sharp</p>	<p>F10-081 16.5 cm 6 1/2" Curved, Sharp</p>	<p>F10-082 16.5 cm 6 1/2" Curved, Sharp</p>



Pictures show the outer diameter



EAR LOOPS - HOOKS

Ohrschlingen - Hakchen

Asas - ganchos auriculares

Anses - crochets auriculaires

Anse - uncini auricolari



**Billeau
Ear Loop**



F10-083
16.5 cm 6 1/2"



F10-084
16.5 cm 6 1/2"



F10-085
16.5 cm 6 1/2"



**Lucae
Hooklet**



F10-086
14 cm 5 1/2"



F10-087
14 cm 5 1/2"



F10-088
14 cm 5 1/2"



**Wagener
Hooklet Buttoned**



F10-089
14 cm 5 1/2"



F10-090
14 cm 5 1/2"



F10-091
14 cm 5 1/2"



F10-092
14 cm 5 1/2"



F10-093
14 cm 5 1/2"



F10-094
14 cm 5 1/2"



F10-095
14 cm 5 1/2"



**Farrell Applicator
F10-096**
16.5 cm 6 1/2"
cross-serrated tip

EAR POLYPUS SNARES



Ohrpolypenschnürer

Serre noeuds auriculaires

Polipótomos auriculares

Serranodi auricolari



Nasal Polypus Snares
F10-097
0.3 mm Ø X 100 mm
In bundles of 12 pieces



Krause Nasal Polypous Snares
F10-098
25.4 cm 10"



Kraus -Vosse Nasal Polypous Snares
F10-099
25.4 cm 10"
With 2 inserts

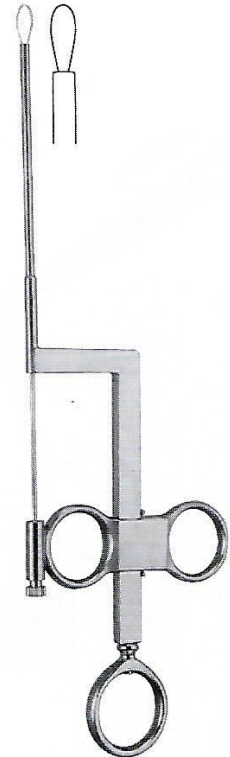

Kraus -Wilde Nasal Polypous Snares
F10-100
24 cm 9 1/2"



F10-101
50CC Complete
F10-102
75CC Complete



Reiner Ear Syringe Tip Only
F10-105
Tip Only



Reiner Ear Syringe Tip Only
F10-106
Tip Only

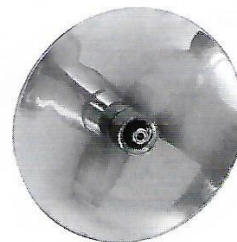

Reiner Ear Syringe Shield
F10-107

F10-103
100CC Complete
F10-104
150CC Complete
Reiner Ear syringe
With Tip & Shield



EAR POLYPUS FORCEPS

Ohrpolypenzangen

Pinces pour polypes auriculaires

Pinzas para pólipos auriculares

Pinze per polipi auricolari



**Littauer Ear
Polypus Forceps
F10-108**
12 cm 4 3/4"



**Hartmann Ear
Polypus Forceps
F10-109**
12 cm 4 3/4"
Delicate jaw



**Hartmann Ear
Polypus Forceps
F10-110**
14 cm 5 1/2"
Normal jaw



**Quire Ear
Polypus Forceps
F10-111**
10.5 cm 4 1/4"
Foreign body lever



**Buck Ear
Polypus Forceps
F10-112**
11.5 cm 4 1/2"
Foreign body forceps

EAR FORCEPS



Ohrzängchen
Pinces auriculaires

Pinzas auriculares
Pinze auricolari



**Hartman
Ear Forceps
F10-113**

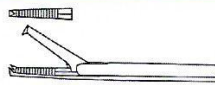

**Hartmann
Ear Forceps
F10-114**
X = 8.5 cm, 3 1/4"
F10-115
X = 14 cm, 5 1/2"

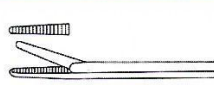

**Hartmann
Ear Forceps
F10-116**
X = 8.5 cm, 3 1/4"
F10-117
X = 14 cm, 5 1/2"
F10-118
X = 16 cm, 6 1/4"

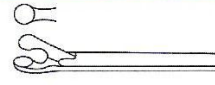

**Hartmann
Ear Forceps
F10-119** 2 mm Ø
X = 8.5 cm, 3 1/4"
F10-120 2.5 mm Ø
X = 8.5 cm, 3 1/4"
F10-121 3 mm Ø
X = 8.5 cm, 3 1/4"



**Hartmann
Ear Forceps
F10-122**

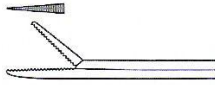

**Hartmann-Wullstein
Ear Forceps
F10-123**
X = 8.5 cm, 3 1/4"



**Hartmann-Wullstein
Ear Forceps
F10-124**
1 mm Ø
X = 8.5 cm, 3 1/4"



**Hartmann-Weingartner
Ear Forceps
F10-125**
X = 8.5 cm, 3 1/4"



**Duckbill
Ear Forceps
F10-126**



**Weingärtner
Ear Forceps
F10-127**

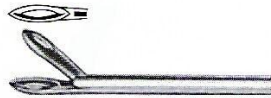

**Strümpel
Ear Forceps
F10-128**



**Hartmann-hoffmann
Ear Forceps
F10-129**

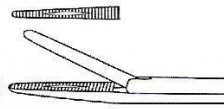

**Hartmann-Noyes
Ear Forceps
F10-130**
X = 9 cm, 3 1/2"

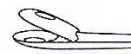

**Struempel
Ear Forceps
F10-131** 0°
X = 8.5 cm, 3 1/4"



**Struempel
Ear Forceps
F10-132** 45°
X = 8.5 cm, 3 1/4"

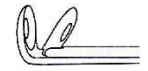

**Struempel
Ear Forceps
F10-133** 90°
X = 8.5 cm, 3 1/4"



**MICRO CUP FORCEPS
F10-134**
X = 75 mm 3"
a = 4.0 mm
b = 1.0 mm
c = 0.9 mm
Straight, Ovel

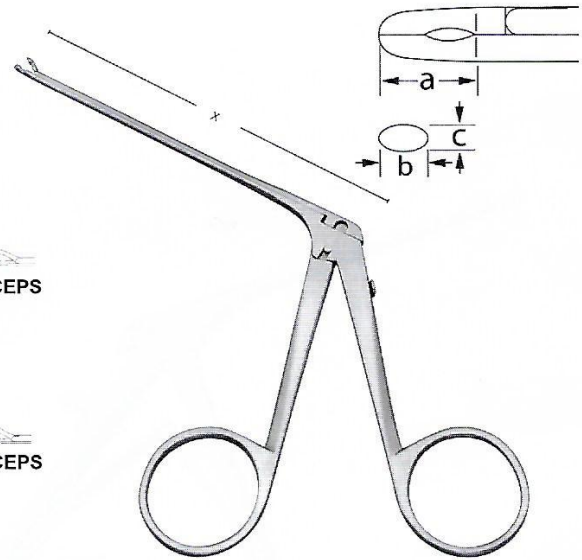

**MICRO CUP FORCEPS
F10-135**
X = 75 mm 3"
a = 4.0 mm
b = 1.0 mm
c = 0.9 mm
Curved upwards, Ovel

MICRO CUP FORCEPS

**MICRO CUP FORCEPS
F10-136**
X = 75 mm 3"
a = 4.0 mm
b = 1.0 mm
c = 0.9 mm
Curved to left, Ovel

**MICRO CUP FORCEPS
F10-137**
X = 75 mm 3"
a = 4.0 mm
b = 1.0 mm
c = 0.9 mm
Curved to right, Ovel

**MICRO CUP FORCEPS
F10-138**
X = 75 mm 3"
a = 4.0 mm
b = 1.0 mm
c = 0.9 mm
Curved downwards, Ovel



BONE-RONGEURS

Ohr-Knochenstanzen
Rongeurs auriculaires

Pinzas osteótomos auriculares
Conchotomi auricolari



**Citelli Bone
Ear Rongeurs
F10-139**
17 cm 6 3/4"
X = 60 mm



**Kerrison Bone
Ear Rongeurs
F10-140**
20 cm 8"
X = 80 mm

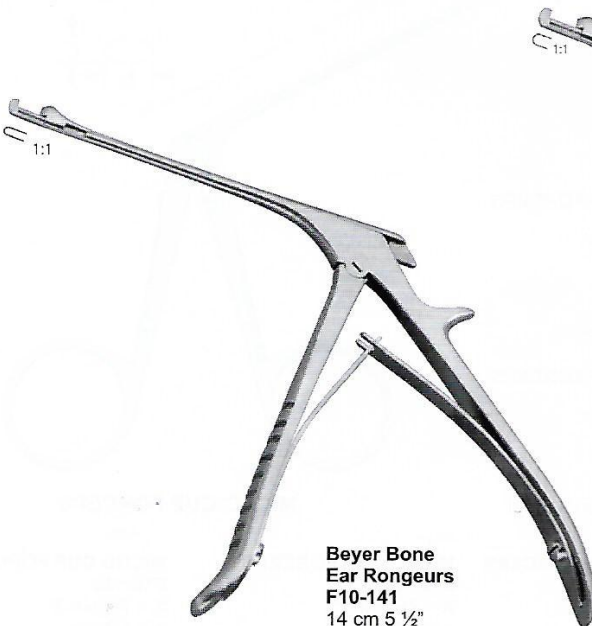

**Beyer Bone
Ear Rongeurs
F10-141**
14 cm 5 1/2"
1 mm



**Beyer Bone
Ear Rongeurs
F10-142**
19 cm 7 1/2"
2 mm

NASAL SPECULA



Nasenspekula
Spéculums nasaux

Especulos nasales
Specoli nasali

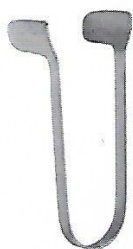

**Thudichum
(Goldsmith)
Nasal Speculum**



F10-143
6.5 cm 2 1/2"
21 mm X 9.5 mm



F10-144
6.5 cm 2 1/2"
21 mm X 10.5 mm

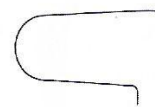

F10-145
6.5 cm 2 1/2"
21 mm X 11.5 mm



**Hartmann
Nasal Speculum**

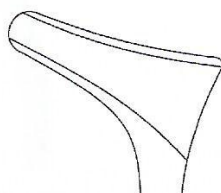

F10-146
16 cm 6 1/4"

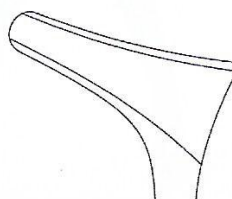

F10-147
16 cm 6 1/4"

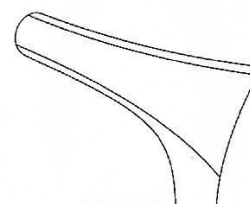

F10-148
16 cm 6 1/4"



**Hartmann-Halle
Nasal Speculum**

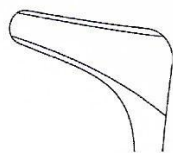

F10-149
15 cm 6"

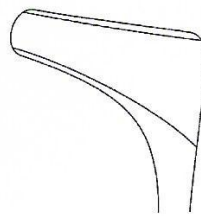

F10-150
15 cm 6"

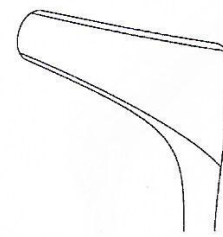

F10-151
15 cm 6"



NASAL SPECULA

Nasenspekula

Especulos nasales

Spéculums nasaux

Specoli nasali

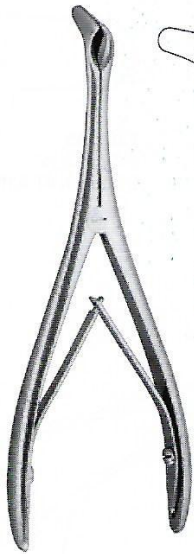

F10-152
13.5 cm 5 1/4"
For babies

Tieck-Halle
Nasal Speculum

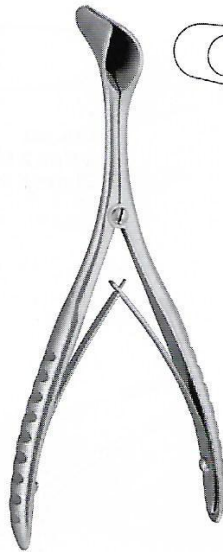

F10-153
14 cm 5 1/2"

Schwarz Nasal Speculum



Vienna Speculum
F10-154
14.6cm 5 3/4"
medium standard patter

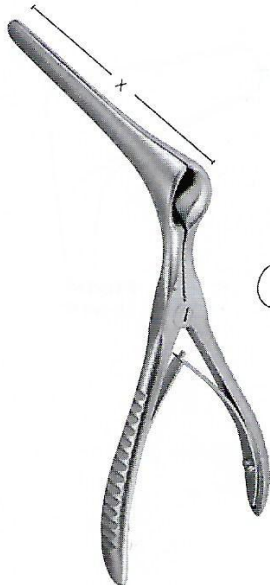

Killian Nasal Speculum

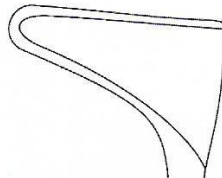

F10-155
13 cm 5"
X = 35 mm

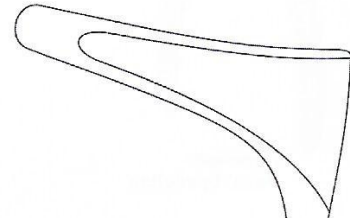

F10-156
13 cm 5"
X = 50 mm

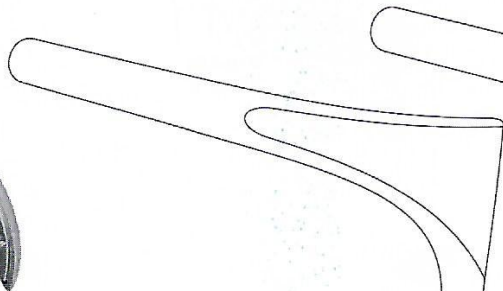

F10-157
13 cm 5"
X = 75 mm

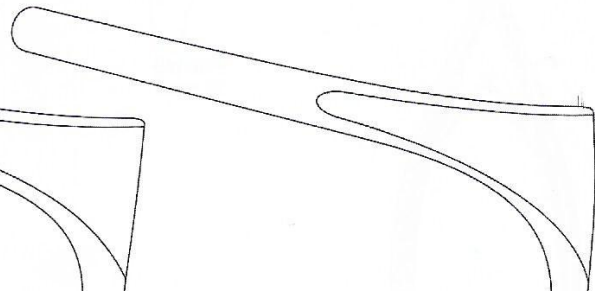

F10-158
13 cm 5"
X = 90 mm

NASAL SPECULA



Nasenspekula
Spéculums nasaux

Especulos nasales
Specoli nasali



Killian Septum Speculum
F10-159
15.2 cm 6"
2.51 cm blades
withset screw



Killian Septum Speculum
F10-160
15.2 cm 6"
8.9cm 3 1/2 blades
set screw

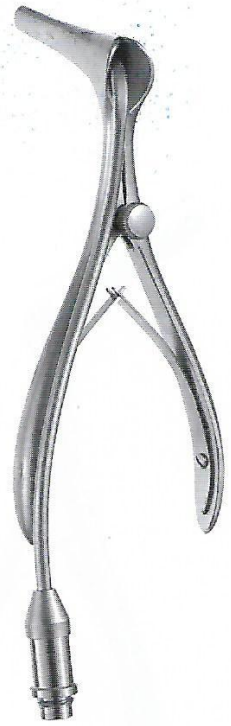

Killian Septum Speculum
F10-161
Fiber Optic 5 1/2" 14.0mm
length 2.51mm deep



**Beckmann
Nasal Speculum**

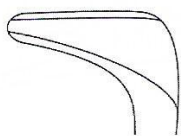

F10-162
15 cm 6"

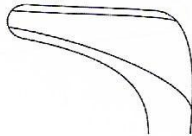

F10-163
15 cm 6"

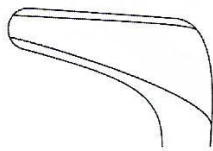

F10-164
15 cm 6"



**Mod. Wien
Nasal Speculum**

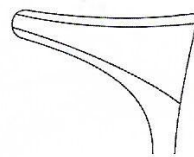

F10-165
14.5 cm 5 3/4"

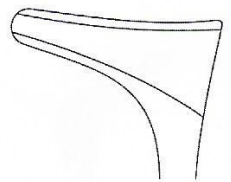

F10-166
14.5 cm 5 3/4"

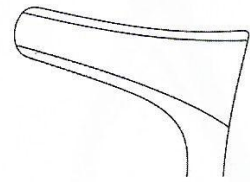

F10-167
14.5 cm 5 3/4"



NASAL SPECULA

Nasenspekula

Especulos nasales

Spéculums nasaux

Specoli nasali



Cottle Nasal Speculum

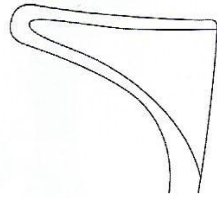

F10-168
15 cm 6"
X = 35 mm

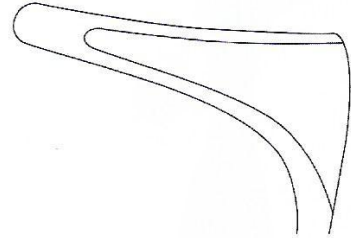

F10-169
15 cm 6"
X = 50 mm

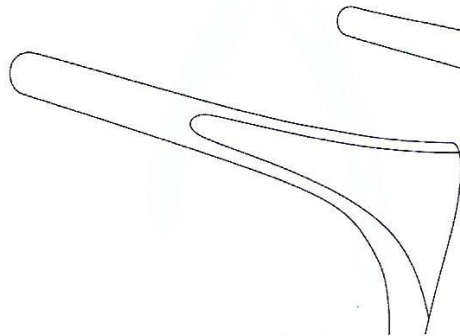

F10-170
15 cm 6"
X = 75 mm

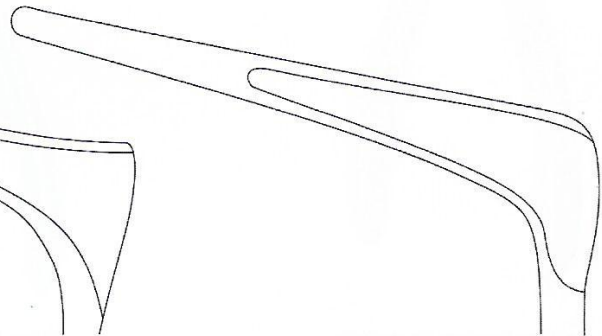

F10-171
15 cm 6"
X = 90 mm

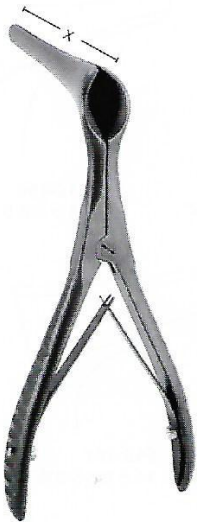

Cottle Nasal Speculum

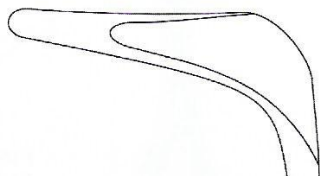

F10-172
14 cm 5 1/2"
X = 45 mm

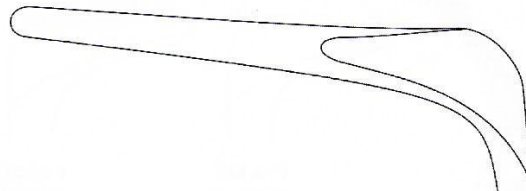

F10-173
14 cm 5 1/2"
X = 75 mm



NASAL SPECULA

Nasenspekula

Especulos nasales

Spéculums nasaux

Specoli nasali



Cottle Nasal Speculum

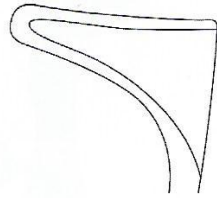

F10-168
15 cm 6"
X = 35 mm

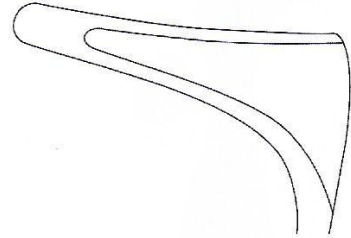

F10-169
15 cm 6"
X = 50 mm

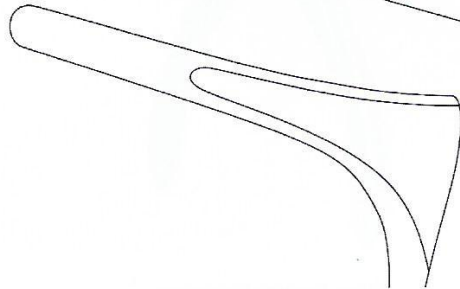

F10-170
15 cm 6"
X = 75 mm

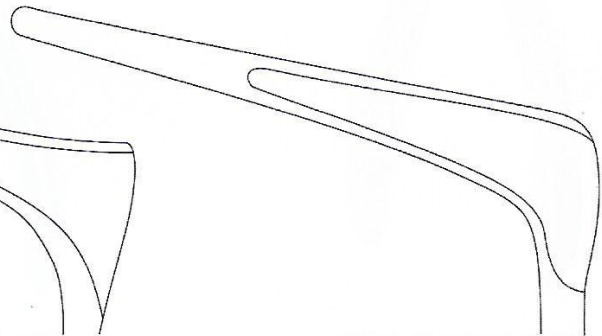

F10-171
15 cm 6"
X = 90 mm

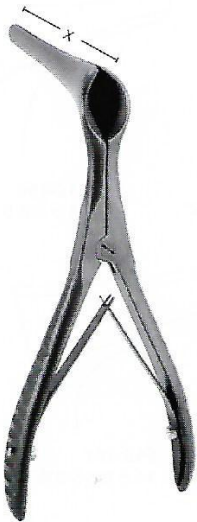

Cottle Nasal Speculum

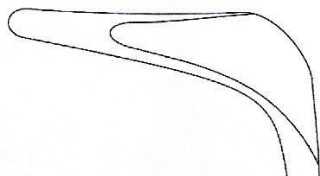

F10-172
14 cm 5 1/2"
X = 45 mm

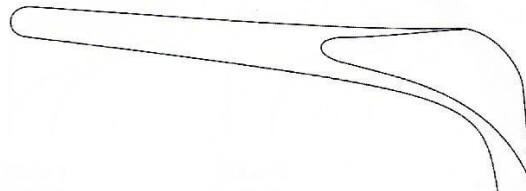

F10-173
14 cm 5 1/2"
X = 75 mm



NASAL POLYPUS & NASAL DRESSING FORCEPS

Nasenpolypenzangen, Nasentamponzange

Pinzas para pólipos nasales, Pinza nasale para tamponamiento

Pinces à polypes nasales, Pince à pansement pour le nez

Pinze per polipi nasali, Pinza per tamponamento nasale

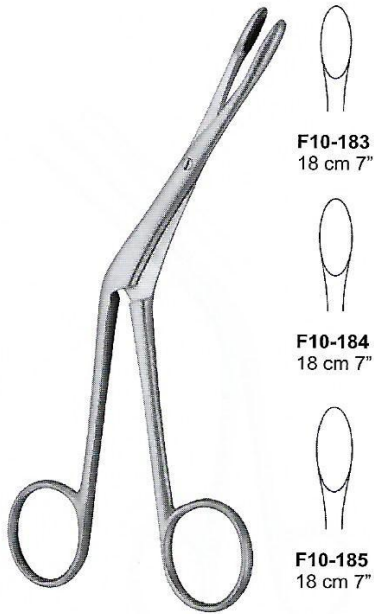

Heymann Nasal Dressing Forceps



Bruenings Nasal Cutting Forceps

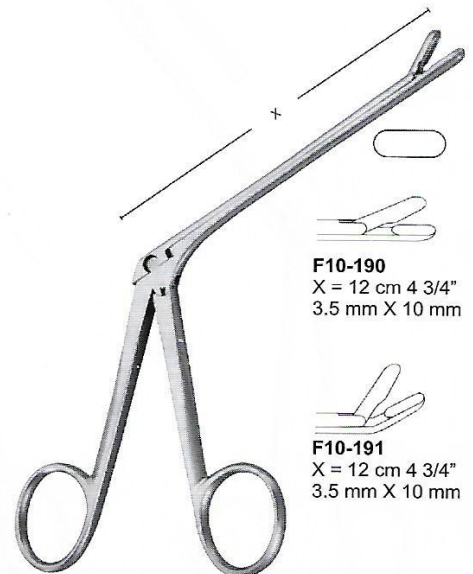

Takahashi Nasal Cutting Forceps



Noyes Nasal Dressing Forceps
F10-192
X = 11 cm 3 1/2"
1 X 2

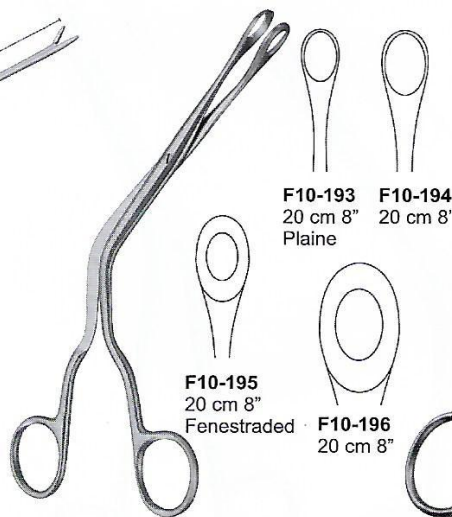

Luc Nasal Cutting Forceps



Weil Nasal Cutting Forceps
F10-197
X = 12 cm 4 3/4"

Watson-Williams Nasal Cutting Forceps
F10-198
X = 12 cm 4 3/4"

F10-199
X = 12 cm 4 3/4"

TONSIL KNIVES



Tonsillennmesser
Couteaux à tonsils

Bisturis para amigdales
Bisturi per tonsille



**Freer
Tonsil Knife
F10-200**
21 cm 8 1/4"



**Freer
Tonsil Knife
F10-201**
21 cm 8 1/4"



**Tonsil Knife
F10-202**
20 cm 8"
Sharp



**Tonsil Knife
F10-203**
20 cm 8"
Sickle knife



**Bruenings
Tonsil Knife
F10-204**
23 cm 9"



**Abraham
Tonsil Knife
F10-205**
22 cm 8 3/4"



**Fischer Tonsil
Knife and Dissector
F10-206**
21.6 cm 8 1/2"
semi-sharp tip, with teeth

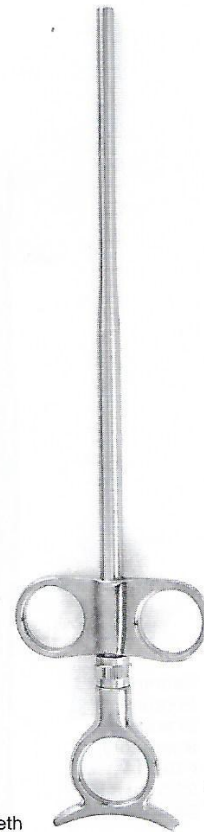

EVE Tonsil Snare
27.9 cm 11"
F10-207 without ratchet
F10-208 with ratchet



SEPTUM ELEVATORS - RASPATORIES

Septum elevatorien - Raspatorien

Elevadores - legras para el tabique nasal

Elevateurs - rugines pour la cloison nasale

Elevatori - periostotomi per setto



**Lempert
Septum
Elevators
Raspatory
F10-209**
20.5 cm 8"
X = 6 mm

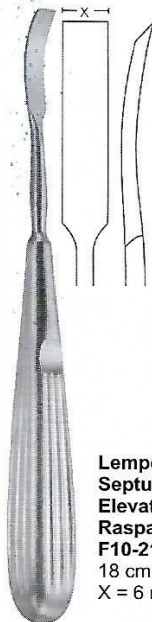

**Lempert
Septum
Elevators
Raspatory
F10-210**
18 cm 7"
X = 6 mm



**Cottle
Septum
Elevators
Raspatory
F10-211**
19 cm 7 1/2"
X = 8 mm
Sharp



**Joseph
Septum
Elevators
Raspatory
F10-212**
16 cm 6 1/4"
X = 5 mm
Periosteal elevators



**Joseph-Masing
Septum Elevators
Raspatory
F10-213**
21.5 cm 8 1/2"
Sharp



**Pennington
Septum
Elevators
Raspatory
F10-214**
21.5 cm 8 1/2"
Blunt

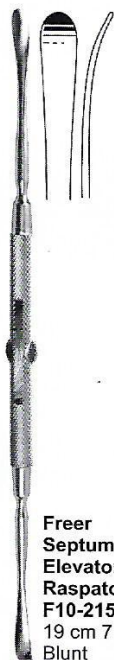

**Freer
Septum
Elevators
Raspatory
F10-215**
19 cm 7 1/2"
Blunt



**Freer
Septum
Elevators
Raspatory
F10-216**
18 cm 7"
Sharp/Blunt



**Freer
Septum
Elevators
Raspatory
F10-217**
20.5 cm 8"
Sharp/Blunt



**Cottle
Septum
Elevators
Raspatory
F10-218**
23.5 cm 9 1/4"
X = 5 mm
Sharp

PERIOSTEAL ELEVATORS, SEPTUM ELEVATORS



Periostelevatorien, Septumelevatorien

Legras para periostio, Elevadores para el tabique nasal

Elevateurs pour la perioste, Elevateurs pour la cloison nasale

Elevatori per il periostio, Elevatori per setto



Masing Periosteal Septum Elevators
F10-219
20 cm 8"



Ballenger-Hajek Periosteal Septum Elevators
F10-220
19 cm 7 1/4"
F10-221
22 cm 8 3/4"



Cottle Periosteal Septum Elevators
F10-222
22 cm 8 3/4"



Cottle Periosteal Septum Elevators
F10-223
21 cm 8 1/4"

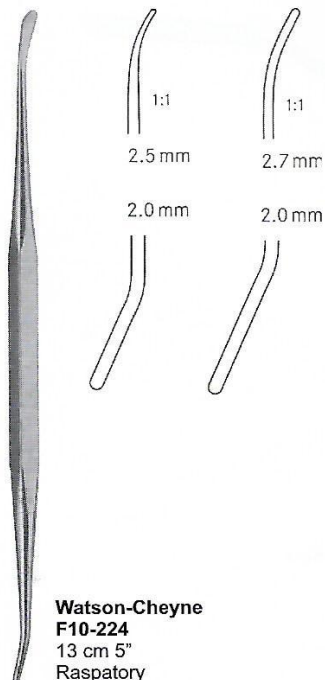

Watson-Cheyne
F10-224
13 cm 5"
Raspatory



Boies
F10-225
19 cm 7 1/2"
Nasal fracture elevator,
Blunt



Goldman
F10-226
17 cm 6 3/4"
Sseptum displacer



NASAL SAWS

Nasensägen
Scies nasales

Sirerras nasales
Seghe nasali



**Joseph Nasal Saw
F10-227**
19 cm 7 1/2"



**Joseph Nasal Saw
F10-228**
19 cm 7 1/2"



**Joseph Nasal Saw
F10-229**
19 cm 7 1/2"



**Maltz Rasp
F10-230**
21 cm 8-1/4"
improved double end
pattern, forward and
backward cutting



**Joseph Rasp
F10-231**
15.9 cm 6-1/4"
fine cross serrations



**Joseph Nasal Saw
F10-232**
17 cm 6 3/4"

**Joseph Nasal Saw
F10-233**
17 cm 6 3/4"

RASPS WITH TUNGSTEN CARBIDE



Raspeln mit Hartmetall

Rapes avec inserts de carbure de tungstene

limas con carburo de tungsteno

raspe con tungsteno

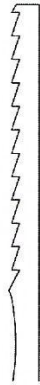
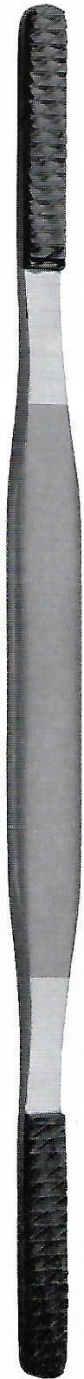

**Fomon
Rasp with
Tungsten
Carbide**



F10-234
20 cm 8"
Teeth 12



F10-235
20 cm 8"
Teeth 16



F10-236
20 cm 8"
Teeth 24



F10-237
20 cm 8"
Teeth 36



F10-238
20 cm 8"
Teeth 52



**Fomon Rasp
with Tungsten
Carbide TC**



F10-239
20 cm 8"
Teeth 14



F10-240
20 cm 8"
Teeth 20



F10-241
20 cm 8"
Teeth 30



F10-242
20 cm 8"
Teeth 44



F10-243
20 cm 8"
Teeth 62



NASAL SAWS

Nasensägen
Scies nasales

Sirerras nasales
Seghe nasali

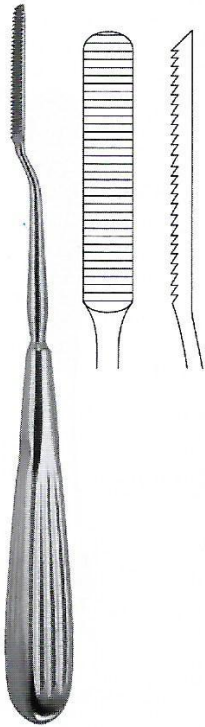

Cottle Nasal Saw
F10-244
21 cm 8 1/4"



Maltz Nasal Saw

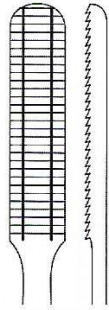

F10-245
17 cm 6 3/4"
34 mm x 7 mm
Pushing cut

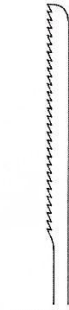

F10-246
17 cm 6 3/4"
34 mm x 7 mm
Drawing cut

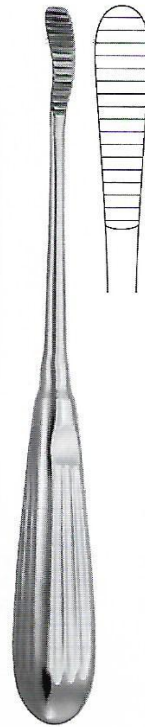

Aufrecht Nasal Saw
Glabella Rasp,
backward cutting



F10-247
21 cm 8 1/4"
Pushing cut

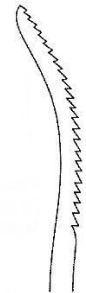

F10-248
21 cm 8 1/4"
Drawing cut



Maltz Nasal Saw

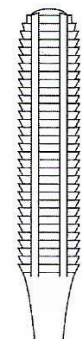

F10-249
17.5 cm 7"
40 mm X 9 mm



Wiener Nasal Saw



F10-250
18 cm 7"
3.5 mm Ø
Antrum rasps

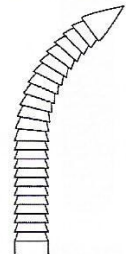

F10-251
18 cm 7"
3.5 mm Ø
Antrum rasps



Gallaher Nasal Saw



F10-252
16 cm 6 1/4"



F10-253
16 cm 6 1/4"



F10-254
16 cm 6 1/4"



Fomon Nasal Saw
F10-255
21 cm 8 1/4"



SEPTUM INSTRUMENTS



Septuminstrumente
instruments pour la cloison nasale

Instrumentos para el tabique nasal
Strumenti per il setto nasale



Bruenings-Brunk
F10-256
19 cm 7 1/2"
Antrum Retractor
Serrated



Ritter-Halle
F10-257 16 cm 6 1/4"
2.5 mm Ø
F10-258 16 cm 6 1/4"
3.0 mm Ø
F10-259 16 cm 6 1/4"
4.0 mm Ø
Forntal sinus bougies

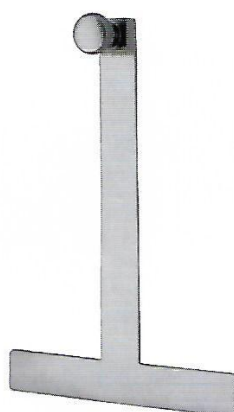

Cottle
F10-260
1.2 cm 4 3/4"
Handle



Cottle
F10-261
7 mm
Guide support
for osteotomes

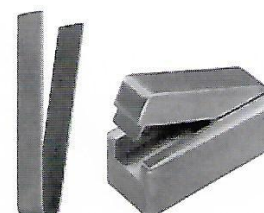

Cottle
F10-262
65 mm X 30 mm X 30 mm
Cartilage crusher



Cottle-Walsham
Septum Forceps

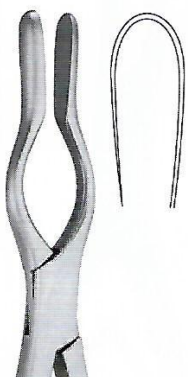

F10-263
23 cm 9"
Straight

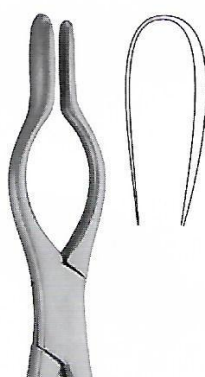

F10-264
23 cm 9"
Left

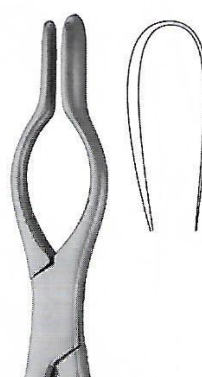

F10-265
23 cm 9"
Right

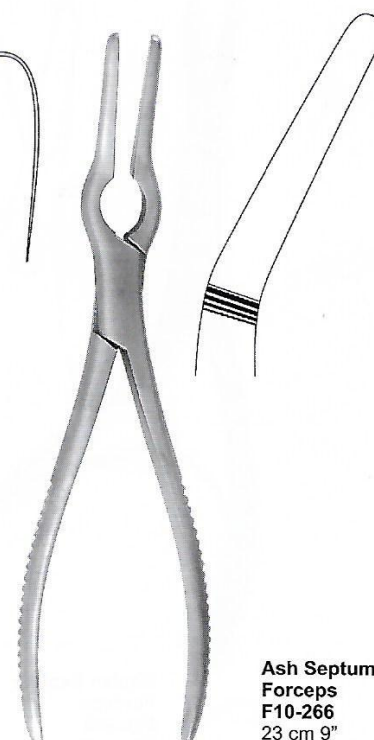

Ash Septum
Forceps
F10-266
23 cm 9"



SEPTUM FORCEPS

Septumzangen

Pinces pour la cloison nasale

Pinzas para el tabique nasal

Pinze per il setto nasale



**Middleton-Jansen
Septum Forceps
F10-267**
19 cm 7 1/2"



**Middleton-Jansen
Septum Forceps
F10-268**
19 cm 7 1/2"

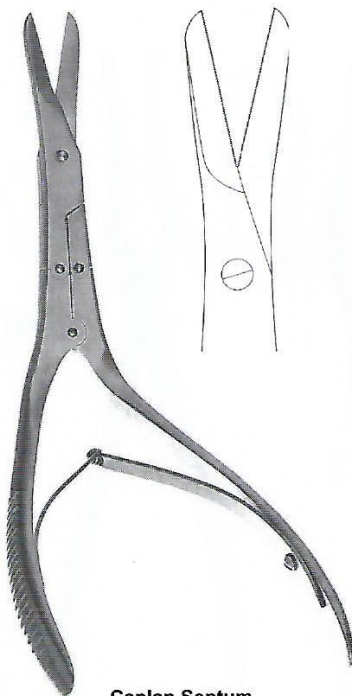

**Caplan Septum
Forceps
F10-269**
20 cm 8"
Toothed



**Rubin Septum
Forceps
F10-270**
21 cm 8 1/4"
Protection cap

RINGMESSER



adenoid currettes

Couteaux a vegetations adenoides

Cuchillos para vegetaciones adenoides

Adenotomi



F10-271
21 cm 8 1/4"



F10-272
21 cm 8 1/4"

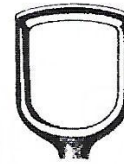

F10-275
22 cm 8 3/4"

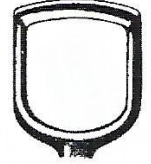

F10-276
22 cm 8 3/4"

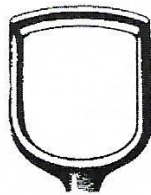

F10-273
21 cm 8 1/4"



F10-274
21 cm 8 1/4"

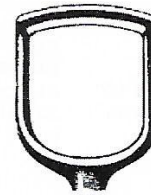

F10-277
22 cm 8 3/4"

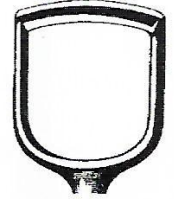

F10-278
22 cm 8 3/4"

**St. Clair-Thomson
Adenoid Curette**

**Barnhill
Adenoid Curette**



F10-279
22 cm 8 3/4"
Straight



F10-280
22 cm 8 3/4"
Straight



F10-281
22 cm 8 3/4"
Straight



F10-285
22 cm 8 3/4"
Curved



F10-286
22 cm 8 3/4"
Curved



F10-287
22 cm 8 3/4"
Curved



F10-282
22 cm 8 3/4"
Straight

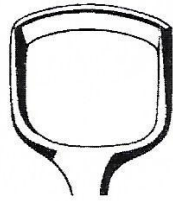

F10-283
22 cm 8 3/4"
Straight

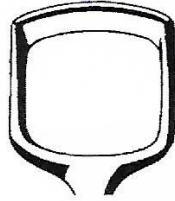

F10-284
22 cm 8 3/4"
Straight

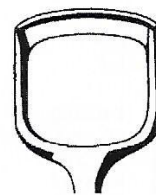

F10-288
22 cm 8 3/4"
Curved

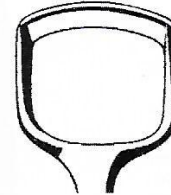

F10-289
22 cm 8 3/4"
Curved

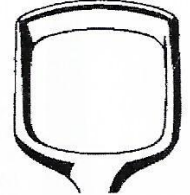

F10-290
22 cm 8 3/4"
Curved

**Beckmann
Adenoid Curette**

**Beckman
Adenoid Curette**



RINGMESSER

adenoid currettes

Couteaux a vegetations adenoides

Cuchillos para vegetaciones adenoides

Adenotomi



La Force

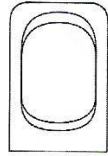

La Force adenotome unperforated Fig 1
F10-291
21.6 cm 8 1/2"
25 x 16.0mm
Infant

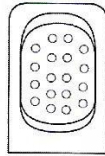

La Force adenotome perforated Fig 1
F10-292
21.6 cm 8 1/2"
25 x 16.0mm
Infant

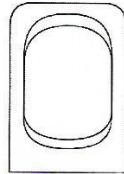

La Force adenotome unperforated Fig 2
F10-293
24.1 cm 9 1/2"
26 x 19.3mm
Medium

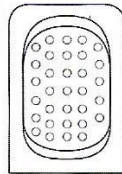

La Force adenotome perforated Fig 2
F10-294
24.1 cm 9 1/2"
26 x 19.3mm
Medium

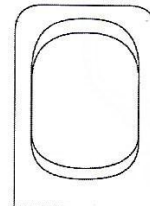

La Force adenotome unperforated Fig 3
F10-295
25 cm 10"
30 x 22.2mm
Large

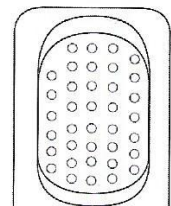

La Force adenotome perforated Fig 3
F10-296
25 cm 10"
30 x 22.2mm
Large



F10-297
20 cm 8"
X = 3 mm
Straight
F10-298
20 cm 8"
Straight
X = 4 mm
F10-299
20 cm 8"
X = 5 mm
Straight

Ballenger Knife

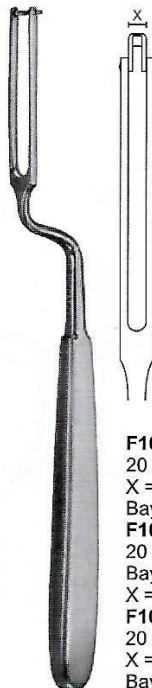

F10-300
20 cm 8"
X = 3 mm
Bayonet
F10-301
20 cm 8"
Bayonet
X = 4 mm
F10-302
20 cm 8"
X = 5 mm
Bayonet

Ballenger Knife



Wieder Tongue Depressor
F10-303 large blade 36mm
wide serrated

Wieder Tongue Depressor
F10-304 43.5mm width blade

MOUTH GAGS



Mundsperrer | Abrebocas
Ouvre-bouches | Apribocca



**Whitehead
Mouth Gag**
F10-305 11 cm 4 1/4"
F10-306 13 cm 5"
F10-307 15 cm 6"



**Jennings
Mouth Gag**
F10-308 9 cm 3 1/2"
F10-309 11 cm 4 1/4"
F10-310 13 cm 5"
F10-311 15 cm 6"

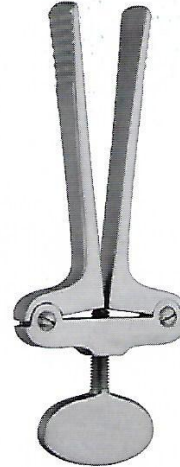

**Heister
Mouth Gag**
F10-312
13 cm 5"



**Maunder
Mouth Gag**
F10-313
10 cm 4"
4 mm Ø
Wood



Molt Mouth Gag
F10-314
11 cm 4 1/4"
For children



Molt Mouth Gag
F10-315
14 cm 5 1/2"
For adults

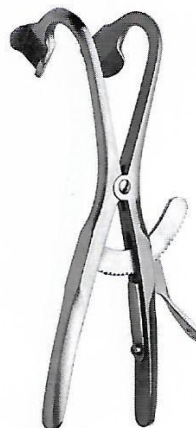

**Denhart
Mouth Gag**
F10-316
12 cm 4 3/4"



**Fergusson-Ackland
Mouth Gag**
F10-317
14.5 cm 5 3/4"



**Roser-Konig
Mouth Gag**
F10-318
16 cm 6 1/4"
F10-319
19 cm 7 1/2"



TONSIL INSTRUMENTS

Tonsillieninstrumente
Instruments pour amygdales

Instrumentos para amígdalas
Strumenti per tonsille



**Jackson
F10-320**
22 cm 8 3/4"
Laryngeal forceps



**Marschik
F10-321**
22 cm 8 3/4"
Tonsil seizing forceps



**Blohmke
Tonsil
Forceps
F10-322**
20 cm 8"



**Colver Tonsil
Forceps
F10-323**
19 cm 7 1/2"
Straight
F10-324
19 cm 7 1/2"
Curved



**White Tonsil
Seizing Forceps
F10-325**
19.1 cm 7 1/2"
F10-326
23 cm 9"

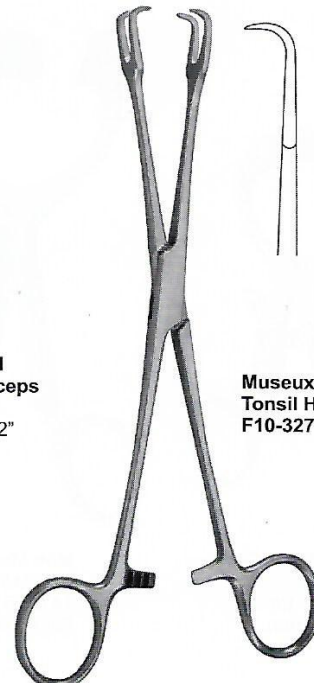

**Museux
Tonsil Holding Forceps
F10-327** 20 cm 8"

TONSIL INSTRUMENTS



Tonsilleninstrumente
Instruments pour amygdales

Instrumentos para amígdalas
Strumenti per tonsille



**Wilde Nasal
Dressing Forceps**
F10-328
16.5cm 6 1/2"
angular



**Troeltsch
Dressing Forceps**
F10-329
11cm, 4 1/2"



**Troeltsch
Dressing Forceps**
F10-330
13 cm, 5"



**Lucae Dressing
Forceps**
F10-331
14 cm, 5 1/2"



**Jansen Dressing
Forceps**
F10-332
16 cm, 6 1/4"



TONSIL INSTRUMENTS

Tonsillieninstrumente

Instruments pour amygdales

Instrumentos para amígdalas

Strumenti per tonsille

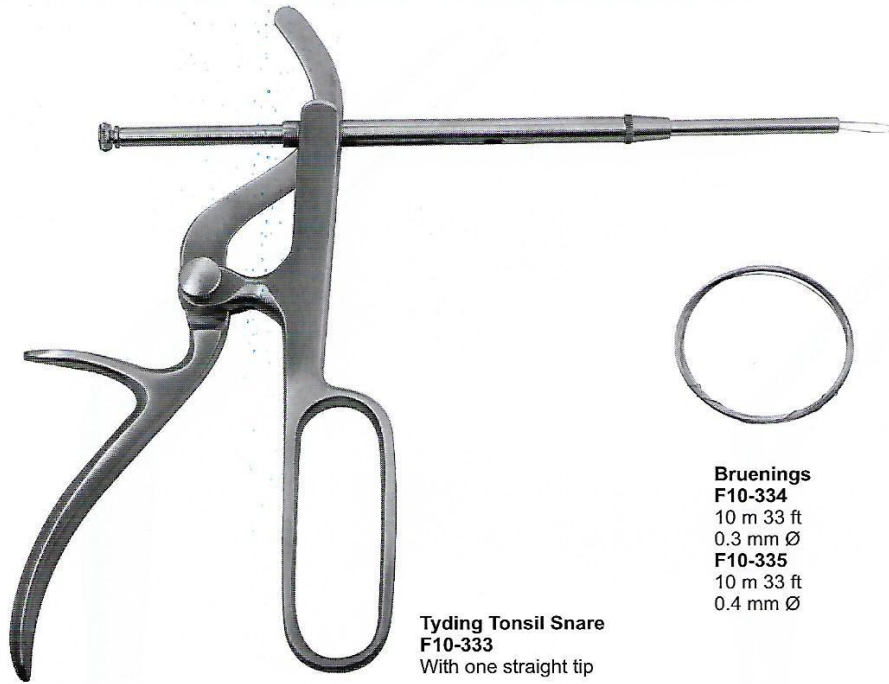

**Tyding Tonsil Snare
F10-333**
With one straight tip



**Bruenings
F10-334**
10 m 33 ft
0.3 mm Ø
F10-335
10 m 33 ft
0.4 mm Ø

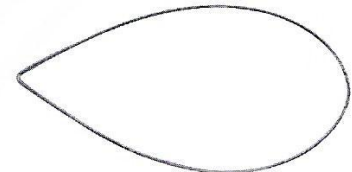

**Bruenings
F10-336**
40 mm
Package of 100 pieces
F10-337
50 mm
Package of 100 pieces



F10-338
28 cm 11"

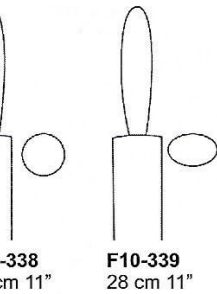

F10-339
28 cm 11"



F10-340
28 cm 11"



F10-341
28 cm 11"

**Bruenings
Tonsil Snare**

LARYNGEAL MIRRORS



Kehlkopfspiegel
Miroirs laryngiens

Especjos laringeos
Specchi laringei

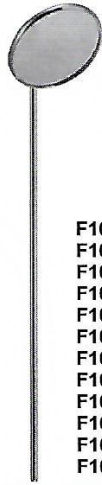

- F10-342 8 mm Ø
- F10-343 10 mm Ø
- F10-344 12 mm Ø
- F10-345 14 mm Ø
- F10-346 16 mm Ø
- F10-347 18 mm Ø
- F10-348 20 mm Ø
- F10-349 22 mm Ø
- F10-350 24 mm Ø
- F10-351 26 mm Ø
- F10-352 28 mm Ø
- F10-353 30 mm Ø

Laryngeal mirrors



Laryngeal Mirrors
Handle
F10-354
10 cm 4"



- F10-355 8 mm Ø
- F10-356 10 mm Ø
- F10-357 12 mm Ø
- F10-358 14 mm Ø
- F10-359 16 mm Ø
- F10-360 18 mm Ø
- F10-361 20 mm Ø
- F10-362 22 mm Ø
- F10-363 24 mm Ø
- F10-364 26 mm Ø
- F10-365 28 mm Ø
- F10-366 30 mm Ø

Laryngeal Mirrors
with Handle



- F10-367 10 mm Ø
- F10-368 12 mm Ø
- F10-369 14 mm Ø
- F10-370 16 mm Ø
- F10-371 18 mm Ø

Michel Moveable
Mirror



TRACHEA DILATORS, TRACHEA TUBES

Trachealdilatatoren, Trachealkanulen

Dilatateurs pour la tracheotomie, Canules pour la tracheotomie

Dilatadores para la traqueotomía, Cabykas oara ka traqyea

Dilatatori tracheali, Cabyke tracheali



Laborde Trachea Dilator 3 Prong
F10-372
14 cm 5 1/2"



Trousseau Trachea Dilator 2 Prong
F10-373
14 cm 5 1/2"



Uckermann Trachea Tubes
F10-374
13 cm 5"
10 mm Ø



Luer-Standard Trachea Tubes
German silver

F10-375 4 mm Ø
F10-376 5 mm Ø
F10-377 6 mm Ø
F10-378 7 mm Ø
F10-379 8 mm Ø
F10-380 9 mm Ø
F10-381 10 mm Ø
F10-382 11 mm Ø
F10-383 12 mm Ø
F10-384 13 mm Ø



Chevalier-Jackson Trachea Tubes
German silver

F10-385 4 mm Ø
F10-386 5 mm Ø
F10-387 6 mm Ø
F10-388 7 mm Ø
F10-389 8 mm Ø
F10-390 9 mm Ø
F10-391 10 mm Ø
F10-392 11 mm Ø
F10-393 12 mm Ø
F10-394 13 mm Ø

LARYNGEAL POLYPUD FORCEPS



Kehlkopfpolypenzangen
Pincas a polypes laryngiens

Pinzas para polipos larigeos
Pinze per polipi laringei

**Jako-Cherry Micro
Laryngoscope
F10-395**
Type II, Newborn
Small, Overall length 114mm
min. I.D. 7.8mm



**Carlens Mediastinoscope, Short
F10-396**
Overall length 116mm, min. I.D. 10.8mm,
nominal proximal dims 16.0mm, max O.D. 18.4mm



**Carlens Mediastinoscope, Long
F10-397**
Overall length 162mm, min. I.D. 11.0mm,
nominal proximal dims 18.0mm, max O.D. 22.3mm



**Carlens Mediastinoscope,
Extra-long
F10-398**
Overall length 191mm, min. I.D. 11.9mm,
nominal proximal dims 19.0mm, max O.D. 22.3mm



**Tucker Mid-Lighted Side Slide
Laryngoscope
F10-399**
Overall length 91mm, min. I.D. 6.9mm

**Tucker Mid-Lighted Side Slide
Laryngoscope, Adolescent
F10-400**
Overall length 106mm, min. I.D. 9.0mm



**Tucker Mid-Lighted Side Slide
Laryngoscope
F10-401 Adult**
Overall length 121mm, min. I.D. 10.7mm

**Tucker Mid-Lighted Side Slide
Laryngoscope
F10-402 Adult Long**
Overall length 160mm, min. I.D. 11.8mm





LARYNGEAL POLYPUD FORCEPS

Kehlkopfpolypenzangen

Pinzas para polipos laringeos

Pinces a polypes laryngiens

Pinze per polipi laringei

(Note) Required size available on Demand

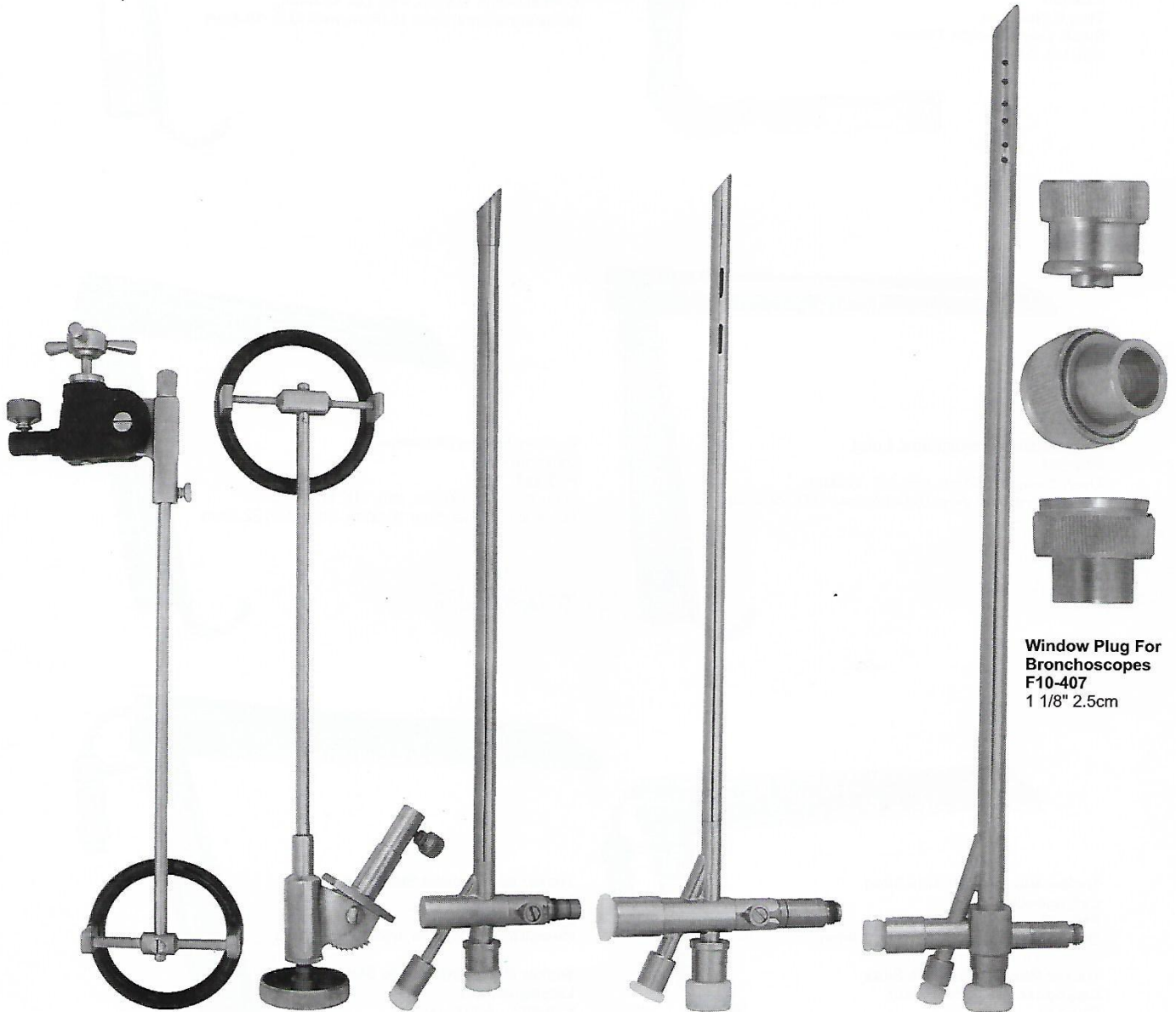

**Window Plug For
Bronchoscopes
F10-407**
1 1/8" 2.5cm

**Laryngoscope Holder
F10-403**
Chest Support
complete, for adults and children

**Holinger Bronchoscope
F10-404 3X20**
Infant, Scope size 3 x 20,
overall length 203mm,
min. I.D. 2.9mm

**Holinger Bronchoscope
F10-405 3.5X20**
Infant, Scope size 3.5 x 20,
overall length 203mm, min.
I.D. 3.5mm

**Holinger Bronchoscope
F10-406 9X40**
Scope size 9 x 40,
overall length 400mm,
min. I.D. 8.5mm

LARYNGEAL POLYPUD FORCEPS



Kehlkopfpolypenzangen
Pinces a polypes laryngiens

Pinzas para polipos laringeos
Pinze per polipi laringei

Jesburg Esophagoscope
F10-408 6 x 8 x 32, Overall
length 317mm,
min. I.D. 5.1mm

Jesburg Esophagoscope
F10-409 6.5 x 10 x 35, Overall
length 349mm,
min. I.D. 5.5mm

Jesburg Esophagoscope
F10-410 7 x 10 x 42, Overall
length 421mm,
min. I.D. 5.8mm

Suction Tube
F10-411
with fix head

Fenestrated Cupped
Grasping Forceps
F10-412

Frazier Suction Tube
F10-413
11 French tip, Working
length 19cm 7 1/2"



NEUROSURGERY

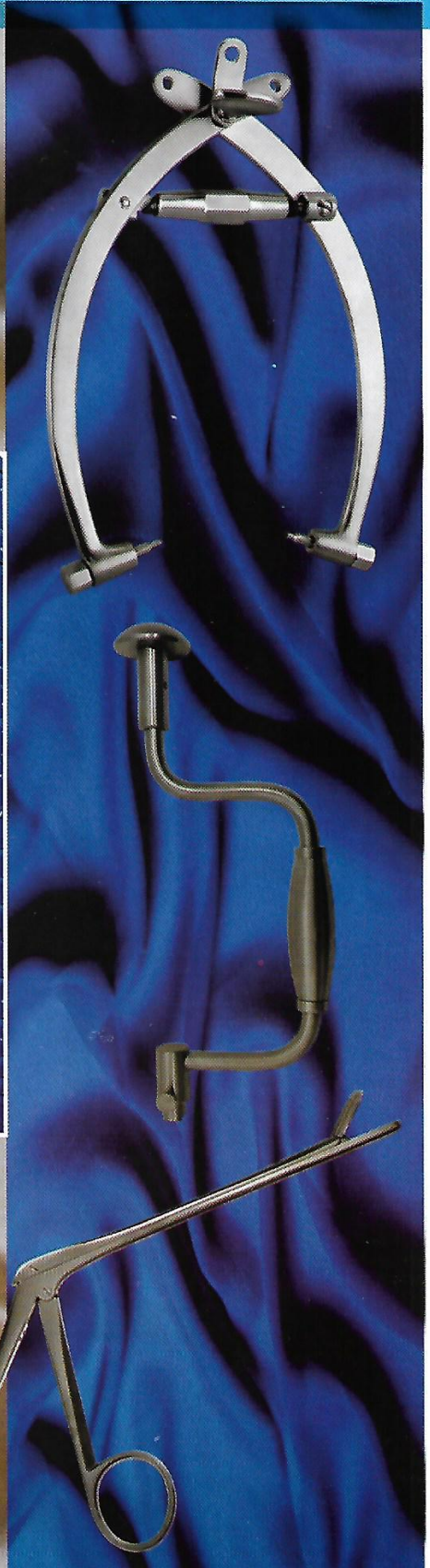
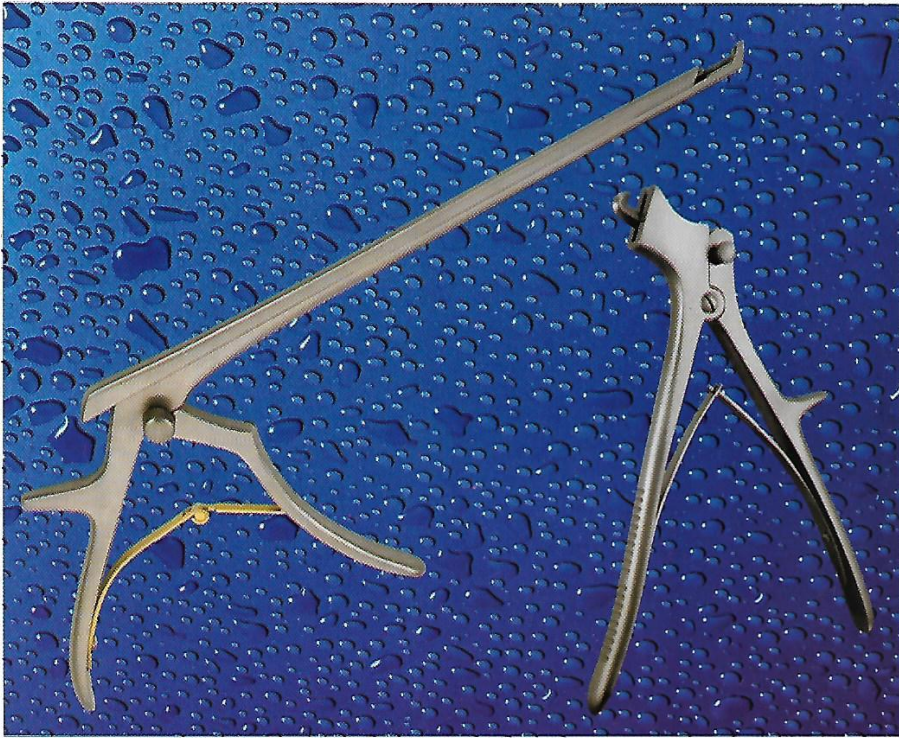
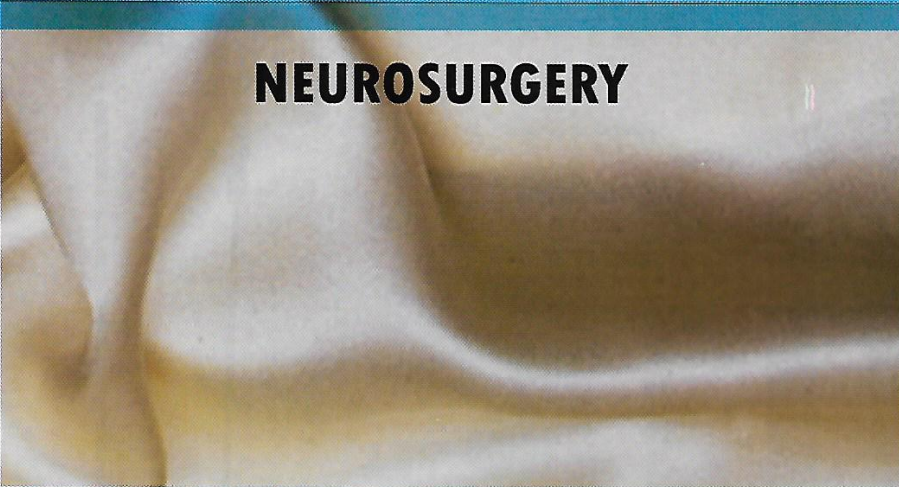

CERVICAL TRACTION TONGS



Schadelhalter

Pinzas de traccion cranial

Pinces de traction Cranienne

Pinze per trazione craniale

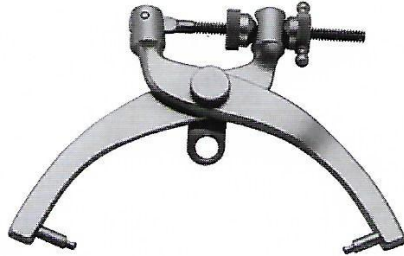

Crutchfield
Traction Tongs
F11-001 13cm
small



Crutchfield drill bit
F11-002 3.5mm



Crutchfield drill bit
F11-003 5.0mm

Set of 2 Pieces for
F11-001 and F11-004



Crutchfield
Traction Tongs
F11-004 18.5cm



Crutchfield Skull
F11-005
large type, cervical traction
tongs-pins adjustable no drilling
to be done 11cm



F11-006
Wrench double
ended for F11-005



De Martel
Saw Conductor
F11-007
33cm 13"

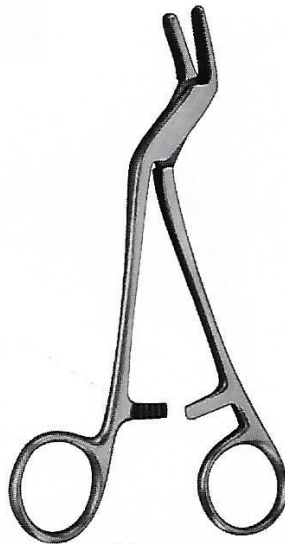

Adson
Drill guide
F11-008
15cm 6"



De Vibiss
Skull Forceps
F11-009
20cm 8 1/4"

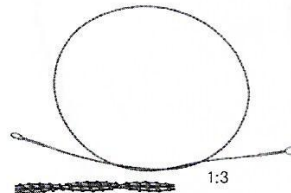

Olivecrona
Wire Saw
F11-010 30cm 12"
F11-011 40cm 16"
F11-012 50cm 20"
F11-013 60cm 23 1/2"
F11-014 70cm 27 1/2"

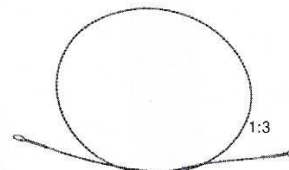

Gigle, Wire Saw
F11-015 30cm 12"
F11-016 40cm 16"
F11-017 50cm 20"
6 wires twisted



Gigle-Strully
Handle for
wire saw
F11-018



BRAIN SPATULAS

Hirnspatel

Spatules cerebrales

Espatules cerebrales

Spatole cerebrali



Supra Cut Distraction Screw

- F11-019 12mm Non Sterile
- F11-020 14mm Non Sterile
- F11-021 16mm Non Sterile
- F11-022 18mm Non Sterile
- F11-023 12mm Sterile
- F11-024 14mm Sterile
- F11-025 16mm Sterile
- F11-026 18mm Sterile



Supra Cut
Distraction
Screw Driver
F11-027



Cushing, brain spatula
F11-028 7mm x 9mm
F11-029 11mm x 13mm
F11-030 15mm x 18mm
F11-031 18mm x 22mm
18cm 7"



Olivecrona
F11-032
brain spatula
18cm 7"



Brain Spatula
F11-033 7mm x 9mm
F11-034 11mm x 13mm
F11-035 15mm x 18mm
F11-036 18mm x 22mm
18cm 7", Convex



Brain Spatula
F11-037 7mm x 9mm
F11-038 11mm x 13mm
F11-039 15mm x 18mm
F11-040 18mm x 22mm
18cm 7", Concave



Heifetz, brain spatula
F11-041 8mm
F11-042 11mm
F11-043 14mm
F11-044 17mm
F11-045 20mm
20cm 8", Malleable

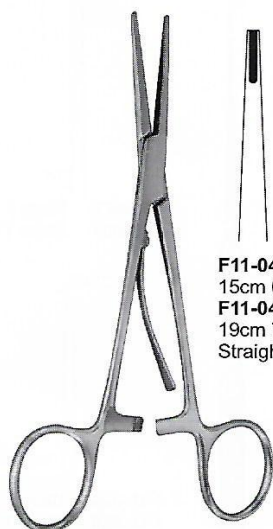

F11-046
15cm 6"
F11-047
19cm 7 1/2"
Straight

McKenzie Clip Applying Forceps

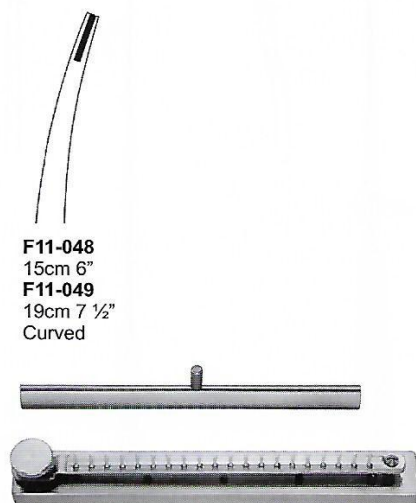

F11-048
15cm 6"
F11-049
19cm 7 1/2"
Curved

McKenzie F11-050 148mm x 40mm x 6mm
5 3/4" x 1 1/2" x 1/2", Brain clip rack for 20 clips

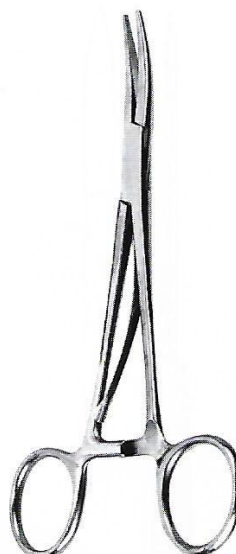

McKenzie Clip Applying Forceps F11-051
Straight Handle, Curved Jaws, 6"



McKenzie Clip Applying Forceps F11-052
Curved Handle, Curved Jaws, 6"

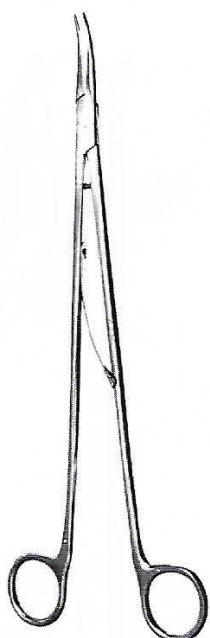

Smithwick Clip Applying Forceps F11-053
9", Curved Jaws
Straight Handle

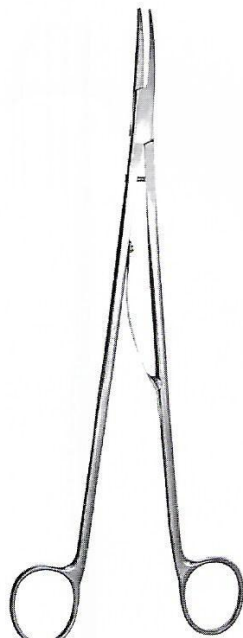

Smithwick Clip Applying Forceps F11-054
10 1/2", Curved Jaws
Straight Handle



Smithwick Clip Applying Forceps F11-055
10 1/2", Straight Jaws
Straight Handle



Schwartz Clip Applying Forceps F11-056 20.3cm 8"
Schwartz Vessel Clip F11-057 1" (2.5cm), Straight Jaws 1.7x 8mm
F11-058 1" (2.5cm), Slightly Angled Jaws 1.7x 8mm
F11-059 1" (2.5cm), Strong Angled Jaws 1.7x 8mm



NERVE HOOKS - DURA HOOKS

Nervenhaken - Durahaken

Crochets a nerfs - Crochets pour duremers

Ganchos para nervios - Ganchos para duramadre

Uncini per nervi - Uncini per duramadre

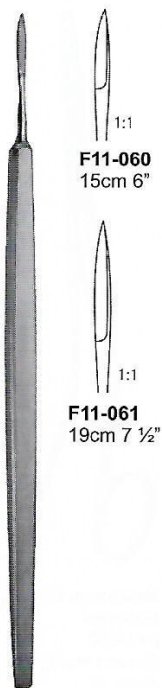

Toennis Nerve Dura Hook



Halle Nerve Dura Hook
F11-062
20cm 8"



Smithwick Nerve Dura Hook
F11-063 17cm 6 3/4"
F11-064 21cm 8 1/4"



Hoen Nerve Dura Hook
F11-065
22cm 8 3/4"

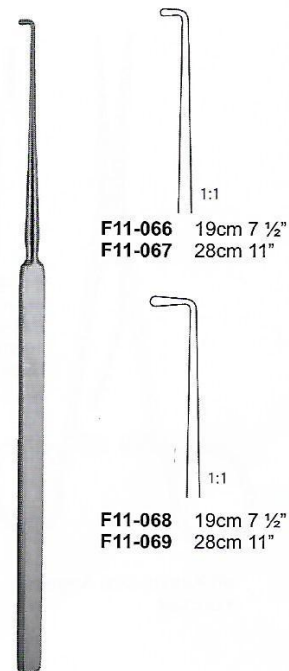

Cushing Nerve Dura Hook

DURA DISSECTORS



Penfield Dura Dissector
F11-070
17.5cm 7"



Penfield Dura Dissector
F11-071
19.5cm 7 3/4"



Penfield Dura Dissector
F11-072
19.5cm 7 3/4"



Penfield Dura Dissector
F11-073
19.5cm 7 3/4"

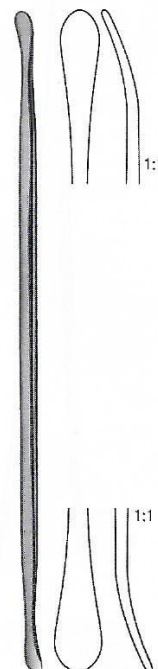

Penfield Dura Dissector
F11-074
19.5cm 7 3/4"

NERVE HOOKS - DURA HOOKS



Nervenhaken - Durahaken

Crochets a nerfs - Crochets pour duremers

Ganchos para nervios - Ganchos para duramadre

Uncini per nervi - Uncini per duramadre



**Love Nerve Dura
Hook Retractor
F11-075**
19cm 7 1/2"
Straight



**Love Nerve Dura
Hook Retractor
F11-076**
19cm 7 1/2"
45° Angled



**Love Nerve Dura
Hook Retractor
F11-077**
19cm 7 1/2"
90° Angled



**Cushing Nerve Dura
Hook Retractor
F11-078**
14cm 5 1/2"



F11-079
13cm 5"
F11-080
18cm 7"
Sharp



F11-081
13cm 5"
F11-082
18cm 7"
Blunt



**Lahey Nerve Dura
Hook Retractor
F11-083**
13cm 5"



**Yasargil Nerve Dura
Hook Retractor**
F11-084 21cm 12 1/4"
F11-085 41cm 16 1/4"
Galea retractor



DURA DISSECTORS

Dura-Dissektoren
Decolleurs duremere

Disectores de duramadre
Dissetori per duramadre



Toennis Dura Dissector
F11-086
25cm 9 3/4"



Davis Dura Dissector
F11-087
24.5cm 9 3/4"

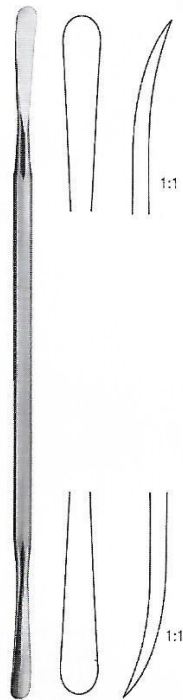

Dura Dissector
F11-088
22cm 8 3/4"



Sachs Dura Dissector
F11-089
21cm 8 1/4"



Sachs Dura Dissector
F11-090
21cm 8 1/4"



Sachs Dura Dissector
F11-091
21cm 8 1/4"

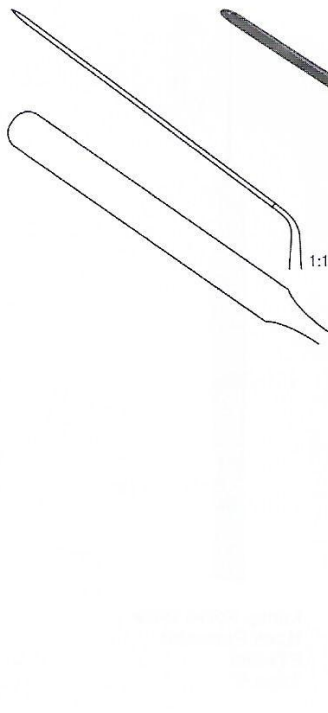

Horsley Dura Dissector
F11-092
20cm 8"

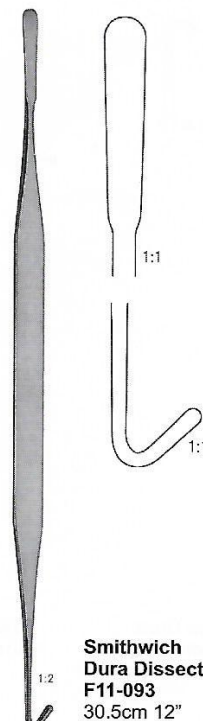

Smithwich Dura Dissector
F11-093
30.5cm 12"

LAMINECTOMY PUNCHES



Laminectomiestanzen

Pinces emporte-pieces a laminectomie

Pinzas cortantes para laminectomia

Pinze taglianti per laminectomia



Cushing Intervertebral

Disc Rongeurs

2 X 10mm, 6"	2 X 10mm, 9"
F11-094 straight	F11-106 straight
F11-095 UP	F11-107 UP
F11-096 Down	F11-108 Down

1.5 X 10mm, 7"	2 X 10mm, 10"
F11-097 straight	F11-109 straight
F11-098 Up	F11-110 UP
F11-099 Down	F11-111 Down

2 X 10mm, 7"	2 X 10mm, 11"
F11-100 straight	F11-112 straight
F11-101 UP	F11-113 UP
F11-102 Down	F11-114 Down

1.5 X 10mm, 9"	2 X 10mm, 12"
F11-103 straight	F11-115 straight
F11-104 Up	F11-116 UP
F11-105 Down	F11-117 Down



Love-Gruenwald

Intervertebral Disc Rongeurs

3 X 10mm, 6"	3 X 10mm, 10"
F11-118 straight	F11-127 straight
F11-119 Up	F11-128 Up
F11-120 Down	F11-129 Down

3 X 10mm, 7"	3 X 10mm, 11"
F11-121 straight	F11-130 straight
F11-122 Up	F11-131 Up
F11-123 Down	F11-132 Down

3 X 10mm, 9"	3 X 10mm, 12"
F11-124 straight	F11-133 straight
F11-125 Up	F11-134 Up
F11-126 Down	F11-135 Down



Spurling Intervertebral

Disc Rongeurs

4 X 10mm, 6"	4 X 10mm, 10"
F11-136 straight	F11-145 straight
F11-137 Up	F11-146 Up
F11-138 Down	F11-147 Down

4 X 10mm, 7"	4 X 10mm, 11"
F11-139 straight	F11-148 straight
F11-140 Up	F11-149 Up
F11-141 Down	F11-150 Down

4 X 10mm, 9"	4 X 10mm, 12"
F11-142 straight	F11-151 straight
F11-143 Up	F11-152 Up
F11-144 Down	F11-153 Down

Micro Cup Forceps

5.5", 0.5mm
F11-154 Straight
F11-155 Right
F11-156 Left

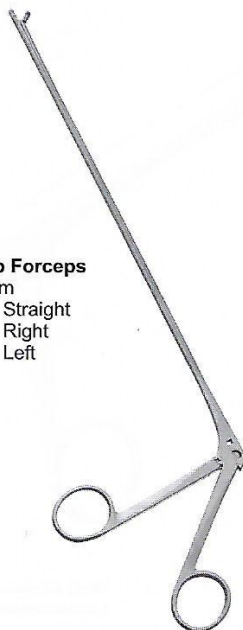

Micro Cup Forceps

5.5", 1mm
F11-157 Straight
F11-158 Right
F11-159 Left



5.5", 2mm
F11-160 Straight

Micro Cup Forceps

8", 200mm, 2mm
F11-161 Straight
F11-162 Up
F11-163 Down

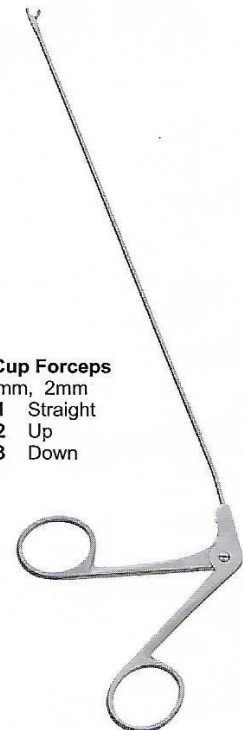



LAMINECTOMY ROUGEURS

Laminektomieezangen

Pinces emporte pieces a laminectomie

Pinzas cortantes para laminectomia

Pinze taglianti per laminectomia



Wilde Intervertebral Disc Rongeurs

7" Straight

- F11-164 2.5mm
- F11-165 3mm
- F11-166 4mm
- F11-167 5mm

7" Angled up

- F11-168 2.5mm
- F11-169 3mm
- F11-170 4mm
- F11-171 5mm

9" Straight

- F11-172 3mm
- F11-173 4mm
- F11-174 5mm

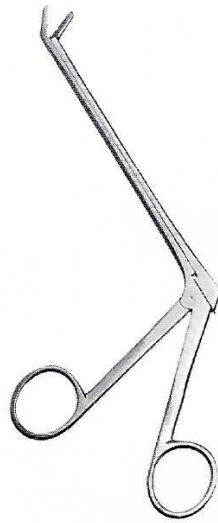

Caspar Type Intervertebral Disc Rongeurs

6.25" Straight

- F11-175 2 x 12mm
- F11-176 3 x 12mm
- F11-177 4 x 14mm
- F11-178 5 x 14mm
- F11-179 6 x 16mm

6.25" Up

- F11-180 3 x 12mm
- F11-181 4 x 14mm
- F11-182 5 x 14mm

6.25" Down

- F11-183 3 x 12mm
- F11-184 4 x 14mm



Caspar Type Intervertebral Disc Rongeurs

7.25" Straight

- F11-185 2 x 12mm
- F11-186 3 x 12mm
- F11-187 4 x 14mm
- F11-188 5 x 14mm
- F11-189 6 x 16mm

7.25" Up

- F11-190 2 x 12mm
- F11-191 3 x 12mm
- F11-192 4 x 14mm
- F11-193 5 x 14mm

7.25" Down

- F11-194 2 x 12mm
- F11-195 3 x 12mm
- F11-196 4 x 14mm



Cushing Intervertebral Disc Rongeurs

w/teeth 2 x 10mm, 7"

- F11-197 Straight
- F11-198 Up
- F11-199 Down

L-G Intervertebral Disc Rongeurs

w/teeth 3 x 10mm, 7"

- F11-200 Straight
- F11-201 Up
- F11-202 Down

3 x 10mm, 10"

- F11-203 Straight

Angle	Length	Fig. 1	Fig. 2	Fig. 2	Fig. 4	Fig. 5
0°	12cm 4 3/4" Straight	3.0mm F11-204	3.5mm F11-205	4.5mm F11-206	5.0mm F11-207	5.5mm F11-208
45°	12cm 4 3/4" 45° up	F11-209	F11-210	F11-211	F11-212	F11-213
90°	12cm 4 3/4" 90° up	F11-214	F11-215	F11-216		
45°	18cm 7" 45° up	Fig. 1 3.0mm F11-217	Fig. 2 3.5mm F11-218	Fig. 2 4.5mm F11-219	Fig. 4 5.0mm F11-220	Fig. 5 5.5mm F11-221
90°	18cm 7" 90° up	F11-222	F11-223	F11-224	F11-225	



Well Blakesley Laminectomy rongeurs

LAMINECTOMY PUNCHES



Laminectomiestanzen

Pinces emporte-pieces a laminectomie

Pinzas cortantes para laminectomia

Pinze taglianti per laminectomia

Spurling Intervertebral Disc Rongeurs

w/teeth 4 x 10mm, 7"

F11-226 Straight

F11-227 Up

F11-228 Down

4 x 10mm, 10"

F11-229 Straight

5 x 10mm, 10"

F11-230 Straight



Schlesinger Intervertebral Disc Rongeurs

F11-231 2 x 10mm, 5" Straight

F11-232 3 x 10mm, 5" Straight

F11-233 4 x 10mm, 5" Straight

F11-234 3 x 10mm, 5" Angled Up



Cloward Intervertebral Disc Rongeurs

serrated 6 x 10mm, 5"

F11-235 Straight

F11-236 Up

F11-237 Down

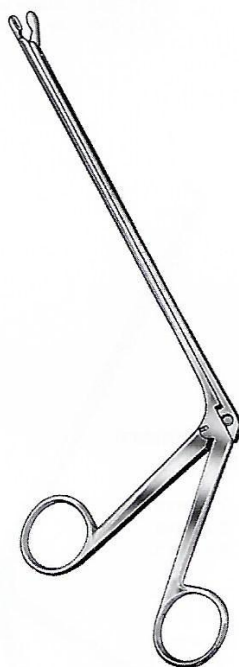

Oldberg Intervertebral Disc Rongeurs

F11-238 6mm Diameter
7-1/8"



Selverstone Intervertebral Disc Rongeurs

F11-239 2 x 3mm, 6"

F11-240 2 x 5mm, 6"



LAMINECTOMY PUNCHES

Laminektomiestanzen

Pinces emporte-pieces a laminectomie

Pinzas cortantes para laminectomia

Pinze taglianti per laminectomia

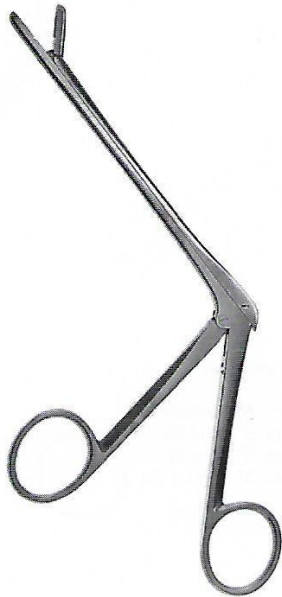

Cushing Intervertebral Disc Rongeurs

2 X 10mm, 5"

F11-241 Straight

F11-242 UP

F11-243 Down

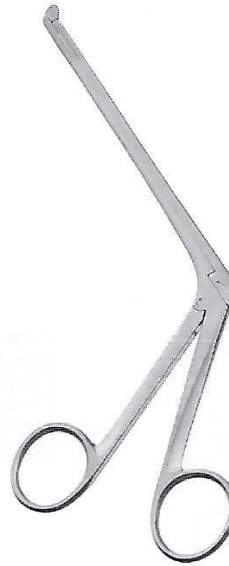

Peapod Intervertebral Disc Rongeurs, 5-1/2"

F11-250 Angle up 1.5mm, x-small

F11-251 Angle up 2mm, small

F11-252 Angle up 2.5mm, medium

F11-253 Angle up 3mm, large



Peapod Intervertebral Disc Rongeurs,

F11-254 Angle up 2.5mm, 7"

F11-255 Angle up 3mm, 7"

F11-256 Angle up 4mm, 7"

F11-257 Straight 2mm, 5-1/2"

F11-258 Straight 2.5mm, 5-1/2"

F11-259 Straight 3mm, 5-1/2"

Love-Gruenwald Intervertebral Disc Rongeurs

3 X 10mm, 5"

F11-244 Straight

F11-245 Up

F11-246 Down

Spurling Intervertebral Disc Rongeurs

4 X 10mm, 5"

F11-247 Straight

F11-248 Up

F11-249 Down



Decker Intervertebral Disc Rongeurs

2 x 5mm, 6"

F11-260 Right

F11-261 Left

F11-262 Down

F11-263 Up

F11-264 Straight



Jackson Intervertebral Disc Rongeurs

70° Up 7"

F11-265 2 x 8mm

F11-266 3 x 8mm

F11-267 4 x 8mm

Williams Style Micro Disc Intervertebral Disc Rongeurs

1 x 2 teeth, Straight

F11-268 5.5"

F11-269 7"

F11-270 10"



LAMINECTOMY PUNCHES



Laminectomiestanzen

Pinces emporte-pieces a laminectomie

Pinzas cortantes para laminectomia

Pinze taglianti per laminectomia

Ferris Smith Micro Kerrison Laminectomy Rongeurs

90° UP 9mm bite opening, 7"

- F11-271 1mm
- F11-272 2mm
- F11-273 3mm
- F11-274 4mm
- F11-275 5mm
- F11-276 6mm

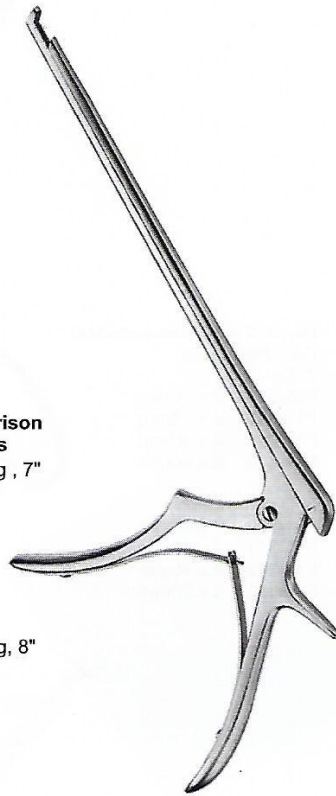

Ferris Smith Micro Kerrison Laminectomy Rongeurs

90° Down 9mm bite opening, 7"

- F11-283 1mm
- F11-284 2mm
- F11-285 3mm
- F11-286 4mm
- F11-287 5mm
- F11-288 6mm



90° UP 9mm bite opening, 8"

- F11-277 1mm
- F11-278 2mm
- F11-279 3mm
- F11-280 4mm
- F11-281 5mm
- F11-282 6mm

90° Down 9mm bite opening, 8"

- F11-289 1mm
- F11-290 2mm
- F11-291 3mm
- F11-292 4mm
- F11-293 5mm
- F11-294 6mm

Micro Ejector Kerrison Laminectomy Rongeurs

40° Up 8"

- F11-295 2mm
- F11-296 3mm
- F11-297 4mm
- F11-298 5mm
- F11-299 6mm



Wide Mouth Ejector Kerrison Laminectomy Rongeurs

40° Up 7"

- F11-300 2mm
- F11-301 3mm
- F11-302 4mm
- F11-303 5mm
- F11-304 6mm

40° Up 8"

- F11-305 2mm
- F11-306 3mm
- F11-307 4mm
- F11-308 5mm
- F11-309 6mm





LAMINECTOMY PUNCHES

Laminektomiestanzen

Pinces emporte-pieces a laminectomie

Pinzas cortantes para laminectomia

Pinze taglianti per laminectomia

Ferris-Smith Intervertebral Disc Rongeurs

7" straight

F11-310	2 x 10mm
F11-311	3 x 10mm
F11-312	4 x 8mm
F11-313	4 x 10mm
F11-314	6 x 10mm
F11-315	6 x 12mm



Ferris-Smith Intervertebral Disc Rongeurs

7" Up

F11-316	2 x 10mm
F11-317	3 x 10mm
F11-318	4 x 10mm
F11-319	6 x 10mm

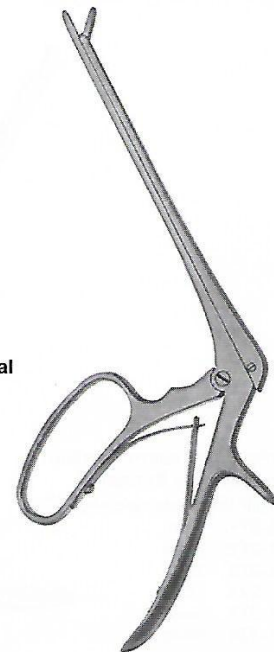

7" Down

F11-320	2 x 10mm
F11-321	3 x 10mm
F11-322	4 x 10mm
F11-323	6 x 10mm



Ferris Smith Micro Kerrison Laminectomy Rongeurs

130° Down Bite, 11" 130° Down Bite, 12"

F11-324	4mm	F11-327	1mm
F11-325	5mm	F11-328	2mm
F11-326	6mm	F11-329	3mm
		F11-330	4mm
		F11-331	5mm
		F11-332	6mm



Kerrison Cervical Rongeur F11-333

17.8 cm 7" shaft, 3 mm
40 degree forward angle



Schlesinger Cervical Rongeur F11-334

thin tips, 6" (15.2 cm) shaft,
up-bite, 3 mm

LAMINECTOMY PUNCHES



Laminektomiestanzen

Pinces emporte-pieces a laminectomie

Pinzas cortantes para laminectomia

Pinze taglianti per laminectomia



**Ferris Smith Micro Kerrison
Laminectomy Rongeurs
Upward**



**Ferris Smith Micro Kerrison
Laminectomy Rongeurs
Downward**

40° UP
9mm bite opening, 7"
F11-335 1mm
F11-336 2mm
F11-337 3mm
F11-338 4mm
F11-339 5mm
F11-340 6mm

40° Down
9mm bite opening, 7"
F11-342 2mm
F11-343 3mm
F11-344 4mm
F11-345 5mm
F11-346 6mm

40° UP
9mm bite opening, 8"
F11-347 1mm
F11-349 2mm
F11-350 3mm
F11-351 4mm
F11-352 5mm
F11-353 6mm

40° Down
9mm bite opening, 8"
F11-354 1mm
F11-355 2mm
F11-356 3mm
F11-357 4mm
F11-358 5mm
F11-359 6mm

40° UP
9mm bite opening, 9"
F11-360 1mm
F11-361 2mm
F11-362 3mm
F11-363 4mm
F11-364 5mm
F11-365 6mm

40° UP
9mm bite opening, 10"
F11-366 2mm
F11-367 3mm
F11-368 4mm
F11-369 5mm
F11-370 6mm

40° UP
9mm bite opening,
F11-371 2mm
F11-372 3mm
F11-373 4mm
F11-374 5mm
F11-375 6mm

40° UP
9mm bite opening, 12"
F11-376 2mm
F11-377 3mm
F11-378 4mm
F11-379 5mm
F11-380 6mm

130° Down
9mm bite opening, 7"
F11-381 1mm
F11-382 2mm
F11-383 3mm
F11-384 4mm
F11-385 5mm
F11-386 6mm

130° Down
9mm bite opening, 8"
F11-387 1mm
F11-388 2mm
F11-389 3mm
F11-390 4mm
F11-391 5mm
F11-392 6mm

130° Down
9mm bite opening, 9"
F11-393 1mm
F11-394 2mm
F11-395 3mm
F11-396 4mm
F11-397 5mm
F11-398 6mm

130° Down
9mm bite opening, 10"
F11-399 1mm
F11-400 2mm
F11-401 3mm
F11-402 4mm
F11-403 5mm
F11-404 6mm

130° Down
9mm bite opening, 11"
F11-405 1mm
F11-406 2mm
F11-407 3mm
F11-408 4mm
F11-409 5mm
F11-410 6mm

130° Down
9mm bite opening, 12"
F11-411 1mm
F11-412 2mm
F11-413 3mm
F11-414 4mm
F11-415 5mm
F11-416 6mm



LAMINECTOMY PUNCHES

Laminektomiestanzan

Pinces emporte-pieces a laminectomie

Pinzas cortantes para laminectomia

Pinze taglianti per laminectomia

Bayonet Micro Kerrison Laminectomy Rongeurs

40° Up, 150 mm	90° Up, 150 mm
Working Length 8"	Working Length 8"
F11-417 1mm	F11-423 1mm
F11-418 2mm	F11-424 2mm
F11-419 3mm	F11-425 3mm
F11-420 4mm	F11-426 4mm
F11-421 5mm	F11-427 5mm
F11-422 6mm	F11-428 6mm

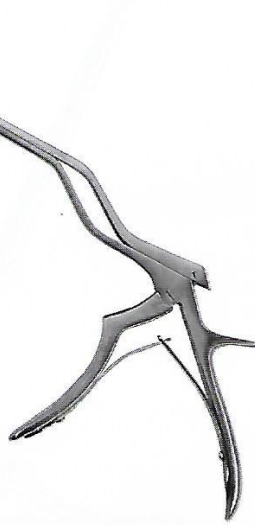

Foramenotomy Kerrison Laminectomy Rongeurs, Curved

F11-441	UP, 9mm Bite opening, 8" 2mm
F11-442	UP, 9mm Bite opening, 8" 3mm
F11-443	UP, 9mm Bite opening, 8" 4mm
F11-444	UP, 9mm Bite opening, 8" 5mm
F11-445	UP, 9mm Bite opening, 8" 6mm
F11-446	Left, 9mm Bite opening, 8" 6mm
F11-447	Right, 9mm Bite opening, 8" 6mm

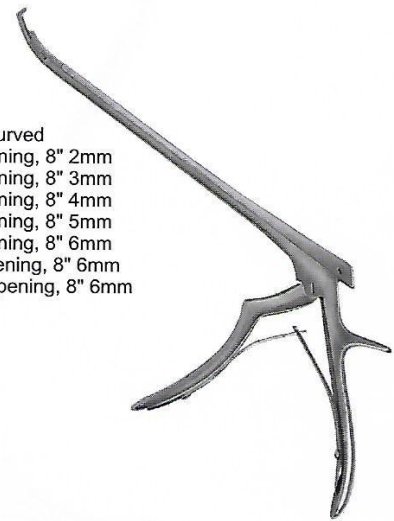

Bayonet Spurling Kerrison Laminectomy Rongeurs

40° Up, 150 mm	90° Up, 150 mm
Working Length 8"	Working Length 8"
F11-429 1mm	F11-435 1mm
F11-430 2mm	F11-436 2mm
F11-431 3mm	F11-437 3mm
F11-432 4mm	F11-438 4mm
F11-433 5mm	F11-439 5mm
F11-434 6mm	F11-440 6mm

40° UP,	15mm Bite Opening, 7"
F11-448	2mm
F11-449	3mm
F11-450	4mm
F11-451	5mm
F11-452	6mm

40° UP,	15mm Bite Opening, 8"
F11-453	2mm
F11-454	3mm
F11-455	4mm
F11-456	5mm
F11-457	6mm



Spurling Kerrison
Laminectomy Rongeurs
Large Handle

40° UP,	15mm Bite Opening, 9"
F11-458	2mm
F11-459	3mm
F11-460	4mm
F11-461	5mm
F11-462	6mm

40° UP,	15mm Bite Opening, 10"
F11-463	2mm
F11-464	3mm
F11-465	4mm
F11-466	5mm
F11-467	6mm

90° UP,	15mm Bite Opening, 7"
F11-473	2mm
F11-474	3mm
F11-475	4mm
F11-476	5mm
F11-477	6mm

90° Down,	15mm Bite Opening, 7"
F11-483	2mm
F11-484	3mm
F11-485	4mm
F11-486	5mm
F11-487	6mm

40° UP,	15mm Bite Opening, 11"
F11-468	2mm
F11-469	3mm
F11-470	4mm
F11-471	5mm
F11-472	6mm

90° UP,	15mm Bite Opening, 8"
F11-478	2mm
F11-479	3mm
F11-480	4mm
F11-481	5mm
F11-482	6mm

90° Down,	15mm Bite Opening, 8"
F11-488	2mm
F11-489	3mm
F11-490	4mm
F11-491	5mm
F11-492	6mm

40° UP, 15mm	Bite Opening, 7"
F11-493	2mm
F11-494	3mm
F11-495	4mm
F11-496	5mm
F11-497	6mm

40° UP, 15mm	Bite Opening, 9"
F11-503	2mm
F11-504	3mm
F11-505	4mm
F11-506	5mm
F11-507	6mm

40° UP, 15mm	Bite Opening, 8"
F11-498	2mm
F11-499	3mm
F11-500	4mm
F11-501	5mm
F11-502	6mm

40° UP, 15mm	Bite Opening, 10"
F11-508	2mm
F11-509	3mm
F11-510	4mm
F11-511	5mm
F11-512	6mm

40° UP, 15mm	Bite Opening, 11"
F11-513	2mm
F11-514	3mm
F11-515	4mm
F11-516	5mm
F11-517	6mm

LAMINECTOMY PUNCHES



Laminektomiestanzen

Pinces emporte-pieces a laminectomie

Pinzas cortantes para laminectomia

Pinze taglianti per laminectomia

Spurling Laminectomy Rongeurs



90° Down, 15mm Bite Opening, 7"
F11-518 2mm
F11-519 3mm
F11-520 4mm
F11-521 5mm
F11-522 6mm

90° Down, 15mm Bite Opening, 8"
F11-523 2mm
F11-524 3mm
F11-525 4mm
F11-526 5mm
F11-527 6mm

Spurling Laminectomy Rongeurs

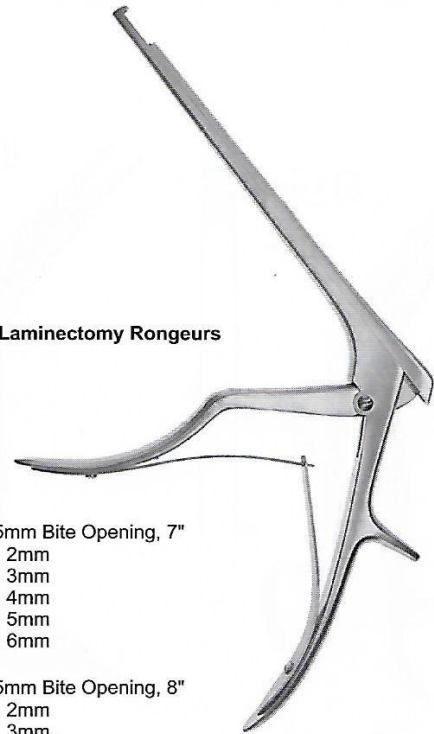

90° UP, 15mm Bite Opening, 7"
F11-528 2mm
F11-529 3mm
F11-530 4mm
F11-531 5mm
F11-532 6mm

90° UP, 15mm Bite Opening, 8"
F11-533 2mm
F11-534 3mm
F11-535 4mm
F11-536 5mm
F11-537 6mm

Micro Ejector Kerrison Laminectomy Rongeurs

40° Up 8"

F11-538 2mm
F11-539 3mm
F11-540 4mm
F11-541 5mm
F11-542 6mm



Wide Mouth Ejector Kerrison Laminectomy Rongeurs

40° Up 7"

F11-543 2mm
F11-544 3mm
F11-545 4mm
F11-546 5mm
F11-547 6mm

40° Up 8"

F11-548 2mm
F11-549 3mm
F11-550 4mm
F11-551 5mm
F11-552 6mm





SPREADER

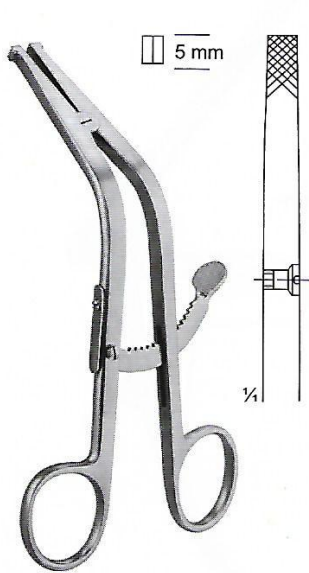

Cloward Retractor
F11-553
15.5 cm, 6"

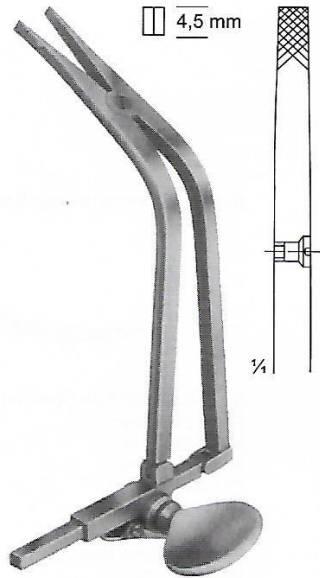

Cloward Retractor
F11-554
13.5 cm, 5 1/4"



Cloward Vertebral Cervical Spreader
F11-555



Spinal Distractor
F11-556 24cm 9 1/2"
45° angle / small style
1/4" rods

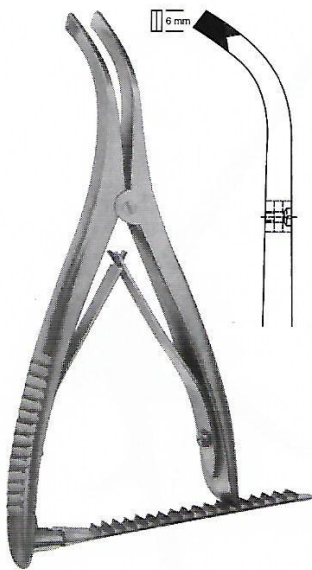

Inge Retractor
F11-557
17.0 cm, 6 3/4"

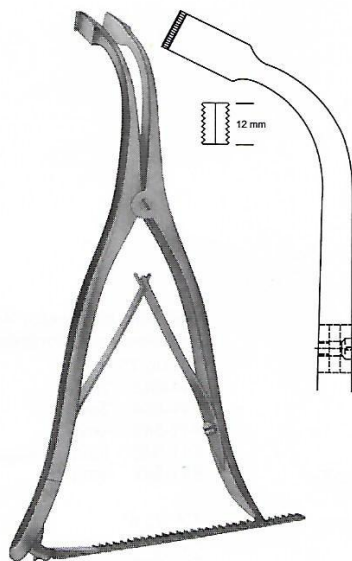

Inge Retractor
F11-558
27.5 cm, 10 3/4"

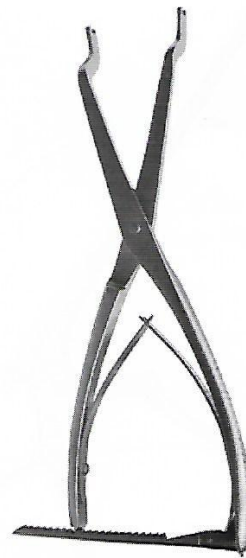

Spinal Distractor
F11-559 25.5cm 10"
small style

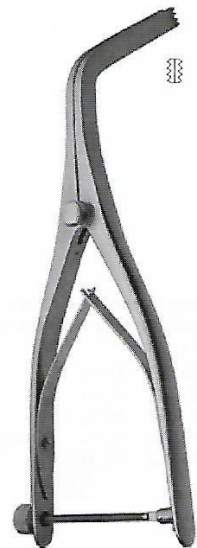

Inge Retractor
F11-560 20cm 8"
toothed w/spindle



INTESTINAL AND RECTAL INSTRUMENTS

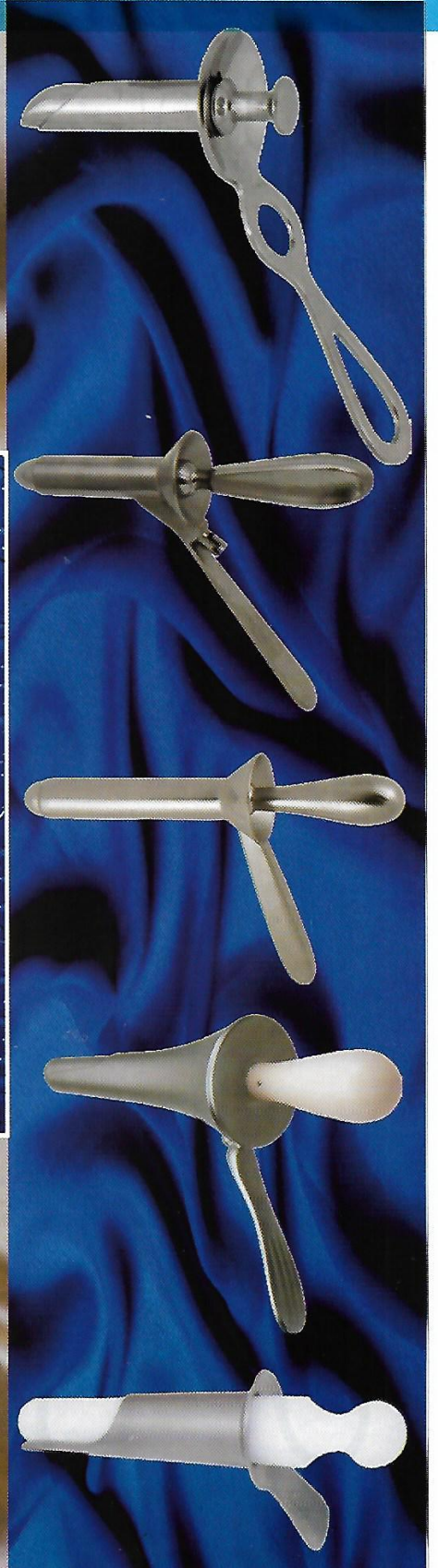



INTESTINAL & TISSUE GRASPING FORCEPS

Darm- und Gewebefassungen
Pinzas Para Intestinos y Tejidos

Pinces Pour Saisir Intestins et Tissus
Pinze Per Afferrare Intestino e Tessuti

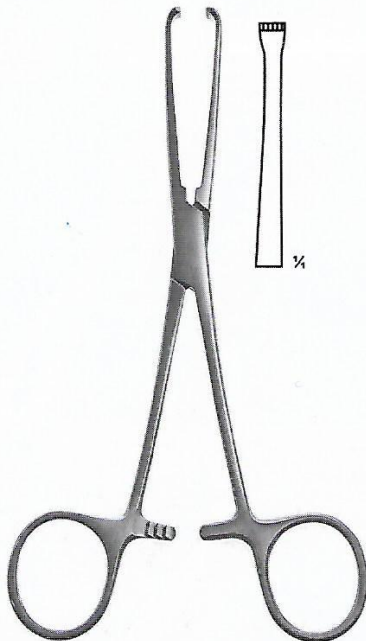

Allis Tissue Forceps
F12-001
3 x 4 teeth
15.5 cm, 6"

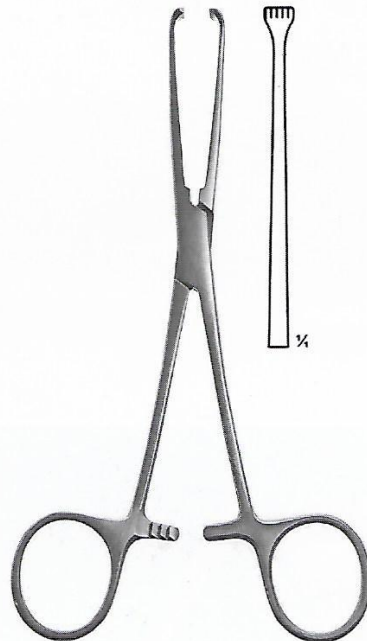

Allis Tissue Forceps
F12-002
4 x 5 teeth
15.5 cm, 6"

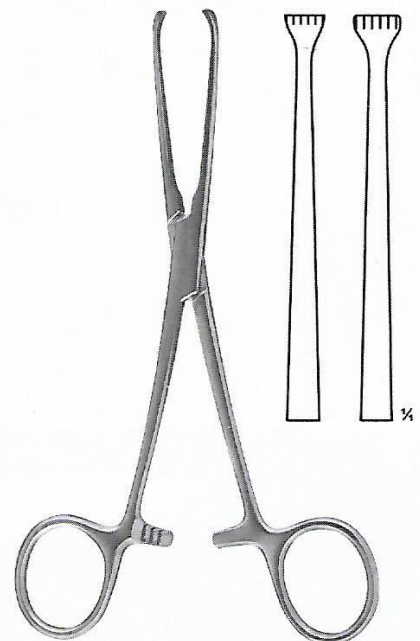

Allis Tissue Forceps
F12-003 19.0 cm, 7 1/2"
F12-004 25.5 cm, 10"
5 x 6 teeth



Baby Allis Tissue Forceps
F12-005
14 cm 5 1/2" 4 X 5 teeth
delicate jaws 4 mm wide

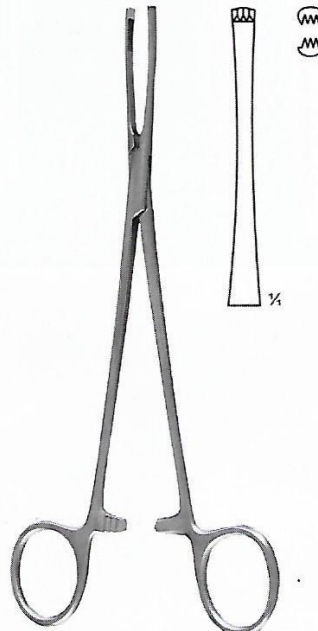

Judd-Allis Tissue Forceps
F12-006
3 x 4 teeth
19.5 cm, 7 3/4"

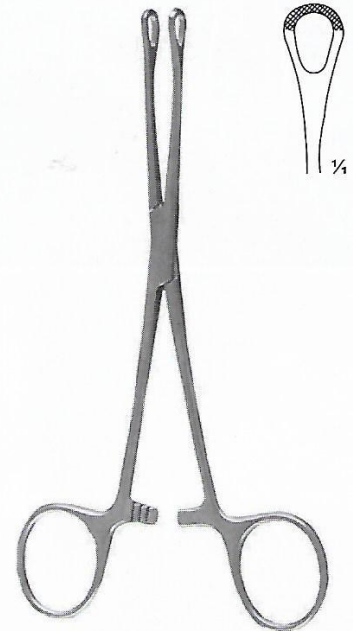

Williams Grasp Forceps
F12-007
16 cm, 6 1/4"

INTESTINAL & TISSUE GRASPING FORCEPS



Darm- und Gewebefassungen
Pinzas Para Intestinos y Tejidos

Pinces Pour Saisir Intestins et Tissus
Pinze Per Afferrare Intestino e Tessuti

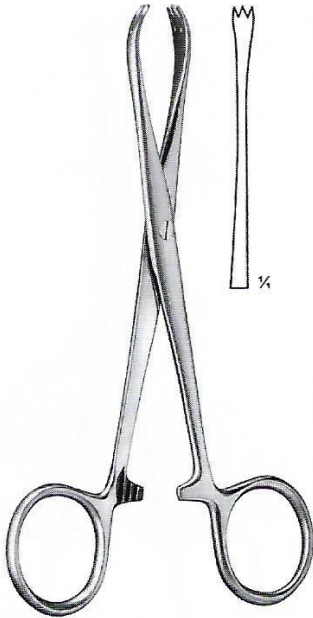

Chaput Tissue Forceps
F12-008
2 x 3 teeth, sharp
12.5 cm, 5"

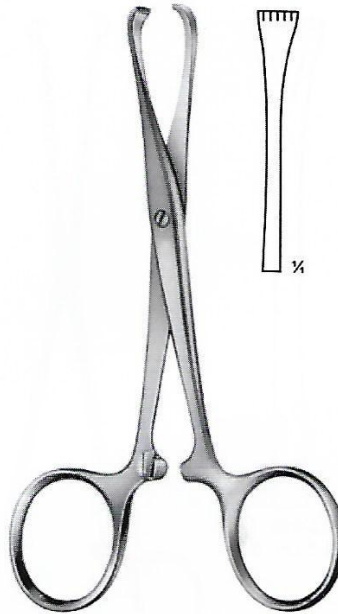

Tuffier Tissue Forceps
F12-009
5 x 6 teeth, sharp
12.5 cm, 5"

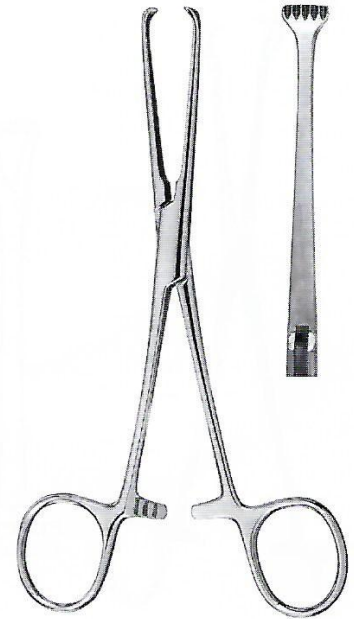

Boys-Allis Tissue Forceps
F12-010
5 x 6 teeth, sharp
15.5 cm, 6"

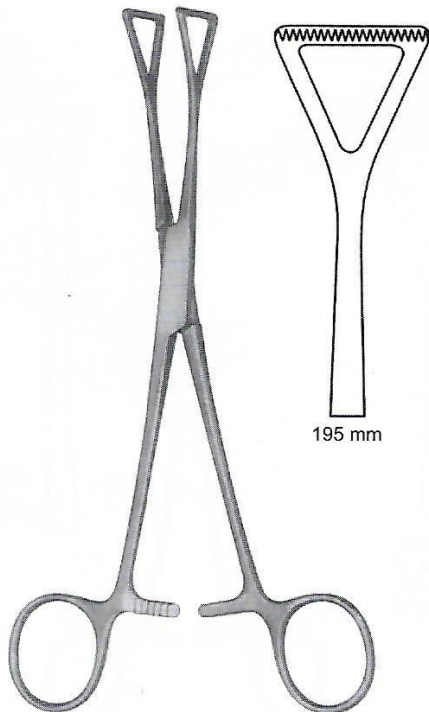

Duval-Collin Grasp Forceps
F12-011 19.5 cm, 7 3/4"
F12-012 20.0 cm, 8"

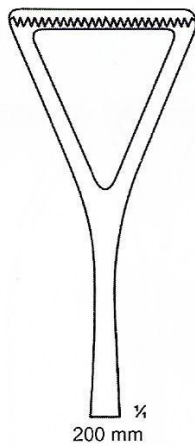

195 mm

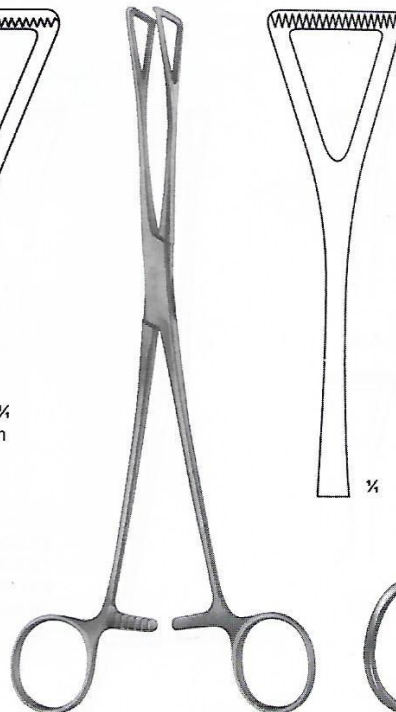

Duval Grasp Forceps
F12-013
23.0 cm, 9"

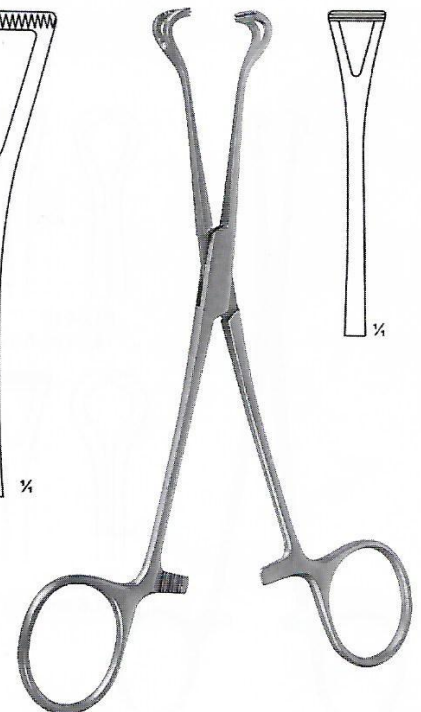

Babcock Seizing Forceps
F12-014
15.5 cm, 6"



INTESTINAL & TISSUE GRASPING FORCEPS

Darm- und Gewebefassungen
Pinzas Para Intestinos y Tejidos

Pinces Pour Saisir Intestins et Tissus
Pinze Per Afferrare Intestino e Tessuti



Babcock Seizing Forceps



F12-015
17.0 cm, 6 3/4"



F12-016
21.5 cm, 8 1/2"

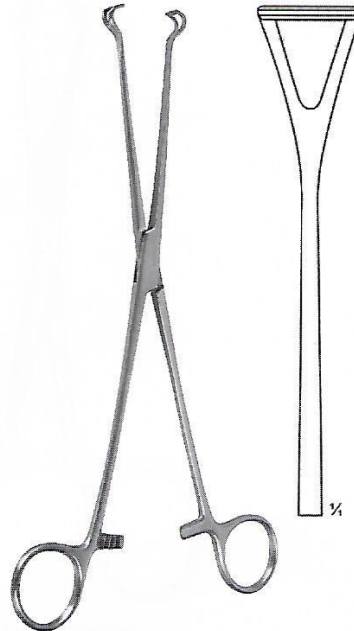

Babcock Seizing Forceps
F12-017
22.0 cm, 8 3/4"



Babcock Tissue Grasping Forceps
F12-018 18 cm, 7"
F12-019 24 cm, 9 1/2"

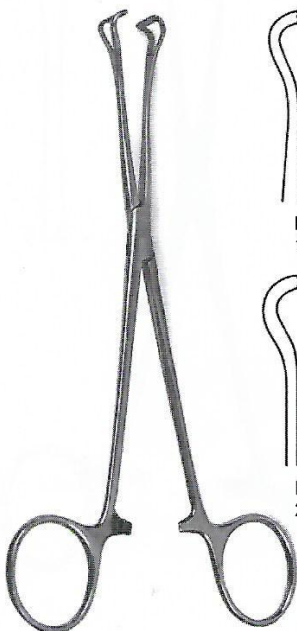

Babcock Tissue Grasping Forceps

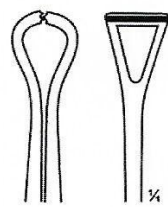

F12-020
16.0 cm, 6 1/4"

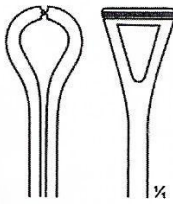

F12-021
21.5 cm, 8 1/2"

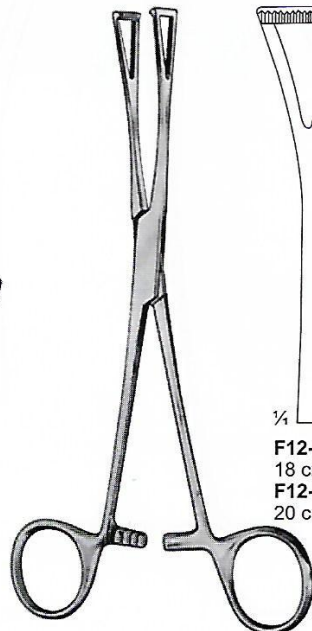

Duval Tissue Grasping Forceps

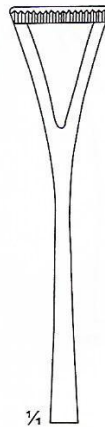

F12-022
18 cm, 7"
F12-023
20 cm, 8"

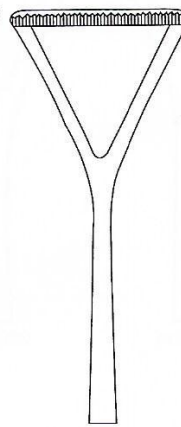

F12-024
20 cm, 8"
F12-025
23 cm, 9"

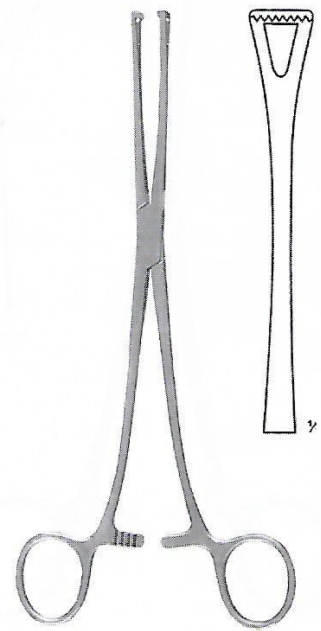

Lockwood Grasp Forceps
F12-026
20.0 cm, 8"

INTESTINAL & TISSUE GRASPING FORCEPS



Darm- und Gewebefasszangen | Pinces Pour Saisir Intestins et Tissus
 Pinzas Para Intestinos y Tejidos | Pinze Per Afferrare Intestino e Tessuti

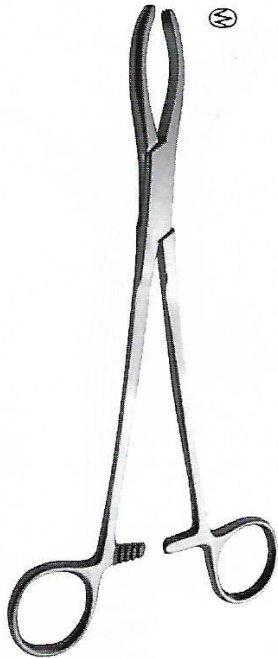

Little Wood Tissue Grasping Forceps
 F12-027 19 cm, 7 1/2"
 Box Joint



Lane Tissue Grasping Forceps
 F12-028 12.7 cm, 5"
 F12-029 15 cm, 6"
 F12-030 19 cm, 7 1/2"

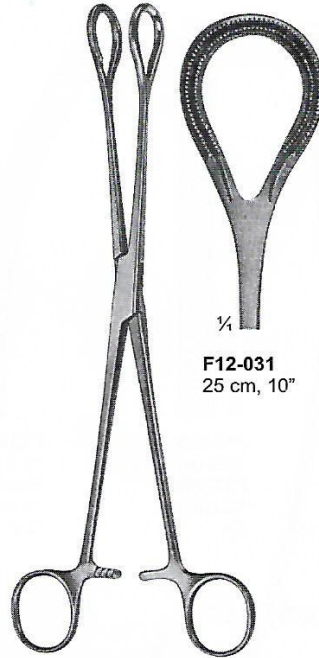

F12-031
 25 cm, 10"



F12-032
 27 cm, 10 3/4"

Duval Intestinal and Tissue Grasping Clamp Forceps



Babcock Intestinal & Tissue Grasping Clamp Forceps T.C

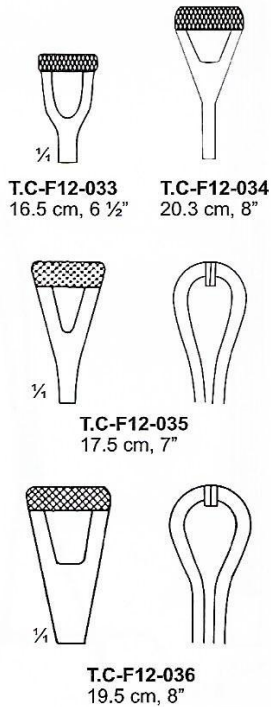

Duval Intestinal & Tissue Grasping Clamp Forceps T.C

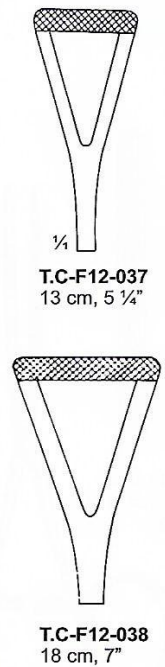



INTESTINAL CLAMPS

Darmklemmen	Pinces Intestinales
Pinzas Intestinales	Pinze Intestinali

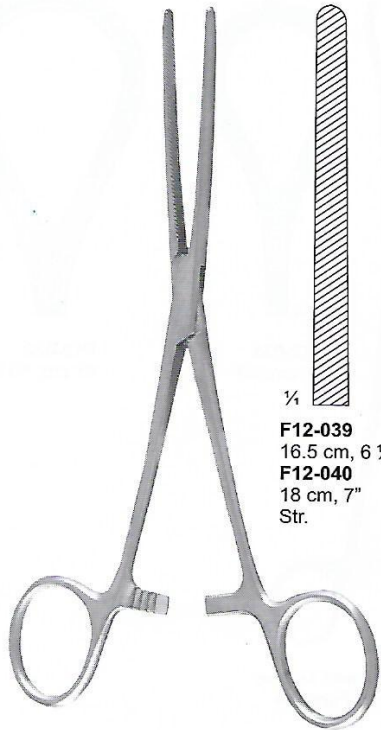

Baby-Doyen Intestinal Forceps Clamps

¼
F12-039
 16.5 cm, 6 ½"
F12-040
 18 cm, 7"
 Str.

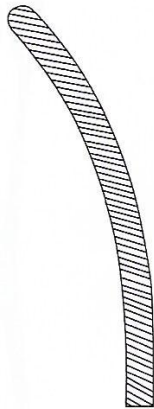

F12-041
 16.5 cm, 6 ½"
F12-042
 18 cm, 7"
 Cvd.



Mayo-Robson Intestinal Forceps Clamps



¼
F12-043
 21 cm, 8 ¼"
F12-044
 23 cm, 9"
F12-045
 25 cm, 10"
 Str.



F12-046
 21 cm, 8 ¼"
F12-047
 23 cm, 9"
F12-048
 25 cm, 10"
 Cvd.

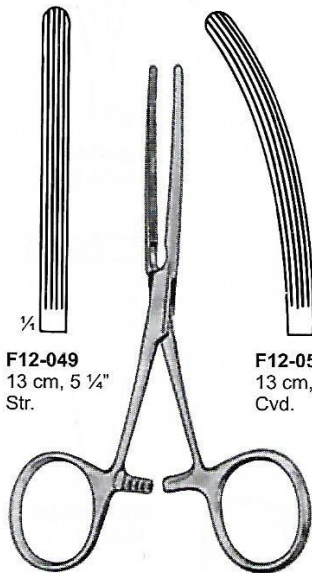

Baby-Kocher Intestinal Forceps Clamps

¼
F12-049
 13 cm, 5 ¼"
 Str.

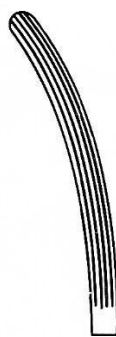

F12-050
 13 cm, 5 ¼"
 Cvd.

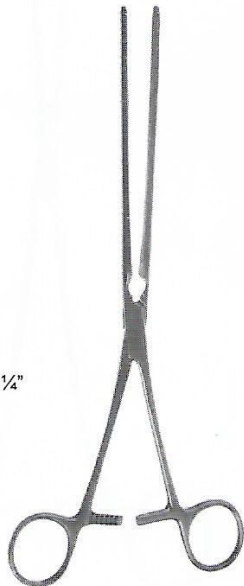

Kocher Intestinal Forceps Clamps



¼
F12-051
 22 cm, 8 ¾"
 Straight

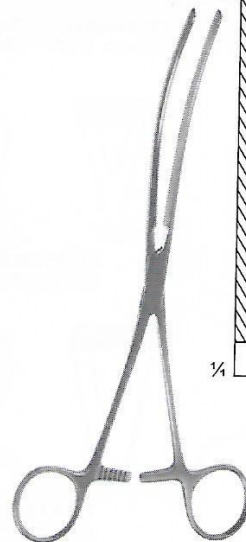

Doyen Intestinal Forceps Clamps



F12-052
 21 cm, 8 ¼"
F12-053
 23 cm, 9"
 straight,
 grooved

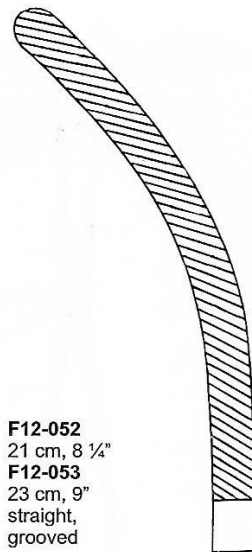

F12-054
 22 cm, 8 ¾"
 Curved,
 grooved

POLYOUS GRASPING FORCEPS, ANASTOMOSIS



Polypenfasszange, Darm-anastomosenklemmen

Pince Pour Saisir Polypes, Pincés-clamps Pour Anastomose Intestinale

Pinza Para Coger Pólipos, Clamps Para Anastomosis Intestinales

Pinze Per Afferrare Polipi, Pinze Per Anastomosi Intestinali

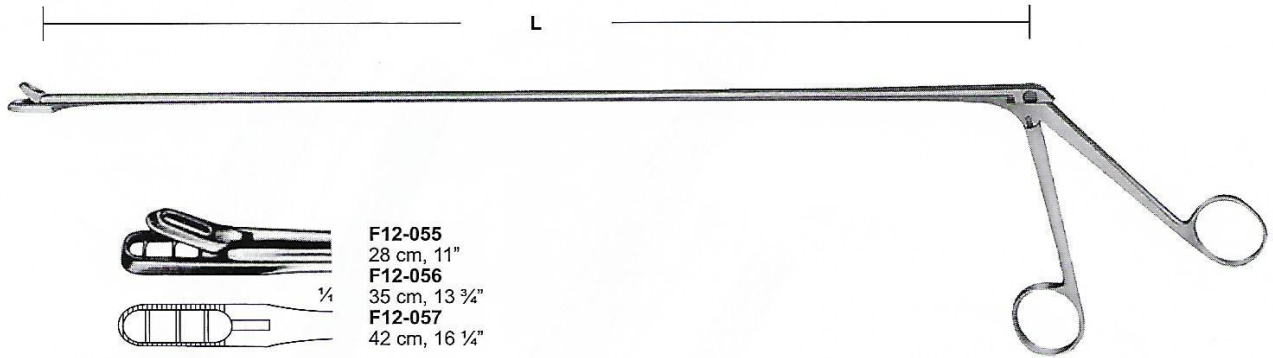

Yeomann Intestinal Polyous Grasping Forceps

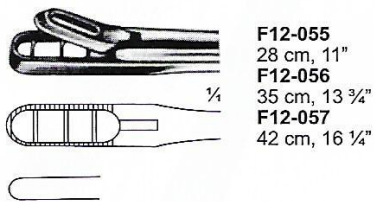

F12-055
28 cm, 11"
F12-056
35 cm, 13 3/4"
F12-057
42 cm, 16 1/4"

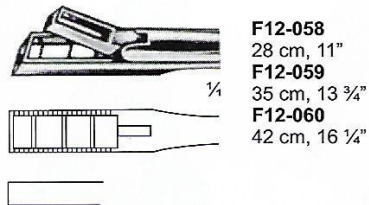

F12-058
28 cm, 11"
F12-059
35 cm, 13 3/4"
F12-060
42 cm, 16 1/4"

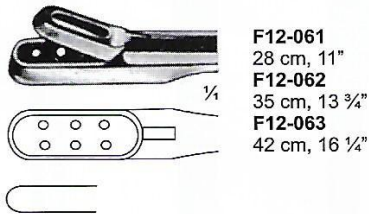

F12-061
28 cm, 11"
F12-062
35 cm, 13 3/4"
F12-063
42 cm, 16 1/4"

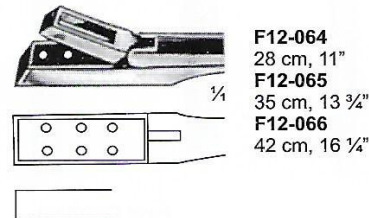

F12-064
28 cm, 11"
F12-065
35 cm, 13 3/4"
F12-066
42 cm, 16 1/4"



INTESTINAL CLAMPS

Darmklemmen | Pincas Intestinales
Pinzas Intestinales | Pinze Intestinali



Payr-Baby Crushing Intestinal Clamp
F12-067
15 cm, 6"
without pin
F12-068
15 cm, 6"
with pin

Payr Crushing Intestinal Clamp
F12-069
21 cm, 8 1/4"
without pin
F12-070
21 cm, 8 1/4"
with pin

Payr Crushing Intestinal Clamp
F12-071
29 cm, 11 1/2"
without pin
F12-072
29 cm, 11 1/2"
with pin

Payr Crushing Intestinal Clamp
F12-073
35 cm, 13 3/4"
without pin
F12-074
35 cm, 13 3/4"
with pin

INTESTINAL CLAMPS



Darmklemmen | Pincas Intestinales
Pinzas Intestinales | Pinze Intestinali



· Lane Stomach Intestinal
Clamp Forceps
F12-075
30 cm, 12" Str.

Lane Stomach Intestinal
Clamp Forceps
F12-076
30 cm, 12" Cvd.



INTESTINAL RECTAL SPECULA

Mastdarmspekula
Especulos Rectales

Spéculums Rectaux
Specoli Rettali

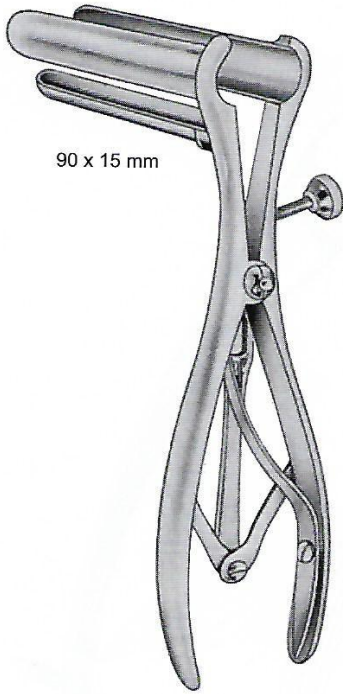

90 x 15 mm

Mathieu Rectal Speculum
F12-077 19.5 cm, 7 3/4"
90 x 15 mm



Sims Rectal Speculum
F12-078 15 cm, 6"



Sims Rectal Speculum
F12-079 15 cm, 6"

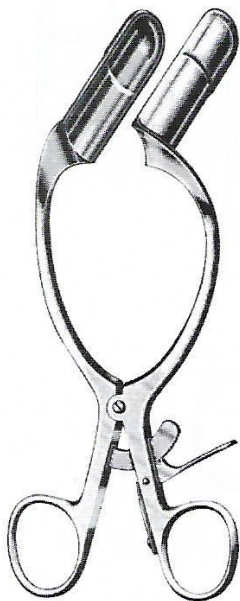

Barr Rectal Speculum
F12-080 80mm
Blade size

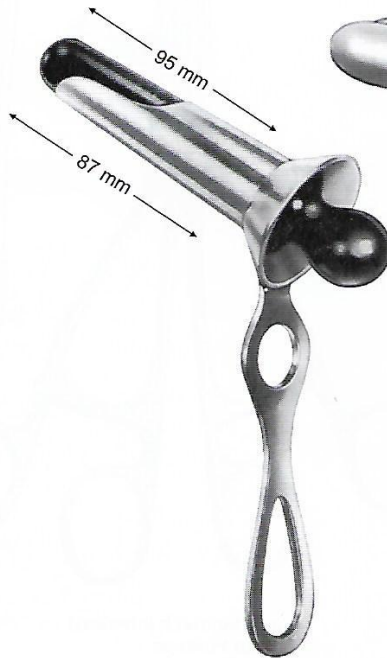

Ives-Fansler Rectal Speculum
F12-081 14.5 mm, 5 3/4"
22 mm Ø



Pratt Rectal Speculum
F12-082 21.5 cm, 8 1/2"
85 x 25 mm blade

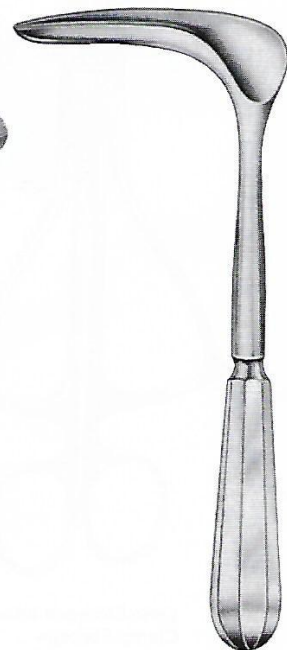

Czerny Rectal Speculum
F12-083
22 cm, 8 3/4"

INTESTINAL RECTAL SPECULA

Mastdarmspekula | Spéculums Rectaux
 Espéculos Rectales | Specoli Rettali



Hirschmann Intestinal Rectal Speculum
F12-084
 23 mm Ø
 proctoscope
 working length: 145 mm



F12-085
 22 Ø x 50 mm
F12-086
 22 Ø x 100 mm
F12-087
 22 Ø x 140 mm
F12-088
 22 Ø x 200 mm

Kelly Intestinal Rectal Speculum



F12-089
 19 Ø x 70 mm
F12-090
 22 Ø x 70 mm

Bensaude Intestinal Rectal Speculum

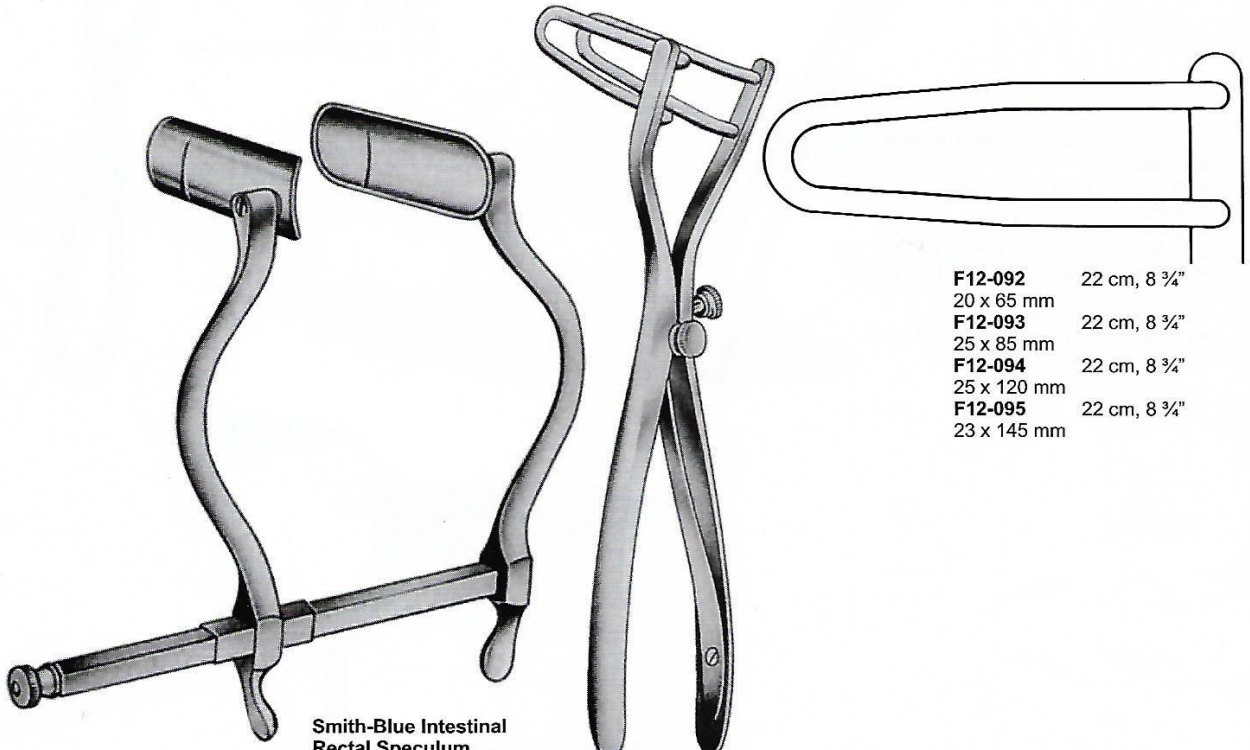

Smith-Blue Intestinal Rectal Speculum
F12-091 15 cm, 6"
 75 x 23 mm

Schulze-Bergmann Intestinal Rectal Speculum

F12-092 22 cm, 8 3/4"
 20 x 65 mm
F12-093 22 cm, 8 3/4"
 25 x 85 mm
F12-094 22 cm, 8 3/4"
 25 x 120 mm
F12-095 22 cm, 8 3/4"
 23 x 145 mm



INTESTINAL RECTAL SPECULA

Mastdarmspekula
Especulos Rectales

Spéculums Rectaux
Specoli Rettali



Barr-Shilford Intestinal Rectal Speculum
F12-096



Vernon-David Intestinal Rectal Speculum
with thumb grip handle
F12-097 short handle
F12-098 long (standard) handle



Fansler Operating Intestinal Rectal Speculum
with slotted / extra long handle
F12-101 standard
F12-102 25 mm x 65 mm (1" x 2 1/2")
F12-103 29 mm x 65 mm (1 1/4" x 2 1/2")
F12-104 38 mm x 70 mm (1 1/2" x 2 3/4")

with slotted tube / short handle
F12-105 29 mm x 60 mm (1 1/4" x 2 1/4")
F12-106 operating speculum



Chelsea-Eaton Intestinal Rectal Speculum
solid handle
F12-099 small
F12-100 large
with light connection available



Brinkerhoff Intestinal Rectal Speculum
F12-107 small 3 1/2" x 1" tapers to 1/2"
F12-108 medium 4" x 1" tapers to 5/8"
F12-109 large 4 3/4" x 1 1/4" tapers to 3/4"

INTESTINAL RECTAL SPECULA

Mastdarmspekula
Especulos Rectales

Spéculums Rectaux
Specoli Rettali



**Ives-fansler Anoscope
Intestinal Rectal Speculum**
with hard rubber obturator /
fenestrated handle
F12-110 22 mm x 85 mm



**Long Chrome Handle
Intestinal Rectal Speculum**
F12-111 3 1/4" x 1 1/8"

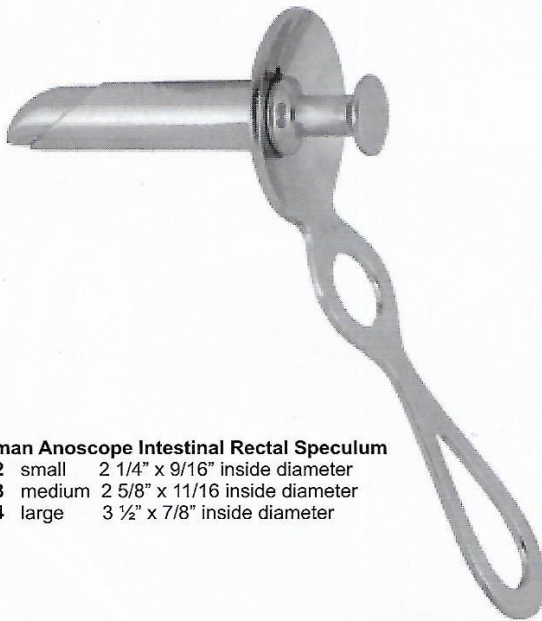

Hirschman Anoscope Intestinal Rectal Speculum
F12-112 small 2 1/4" x 9/16" inside diameter
F12-113 medium 2 5/8" x 11/16" inside diameter
F12-114 large 3 1/2" x 7/8" inside diameter



**Buie Hirschman Anoscope Intestinal
Rectal Speculum**
F12-115 small 2 1/4" x 9/16" inside diameter
F12-116 medium 3 3/4" x 3/4" inside diameter
F12-117 large 3 7/8" x 15/16" inside diameter

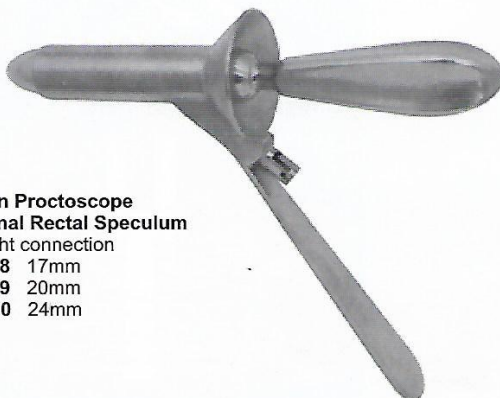

**Morgen Proctoscope
Intestinal Rectal Speculum**
with light connection
F12-118 17mm
F12-119 20mm
F12-120 24mm

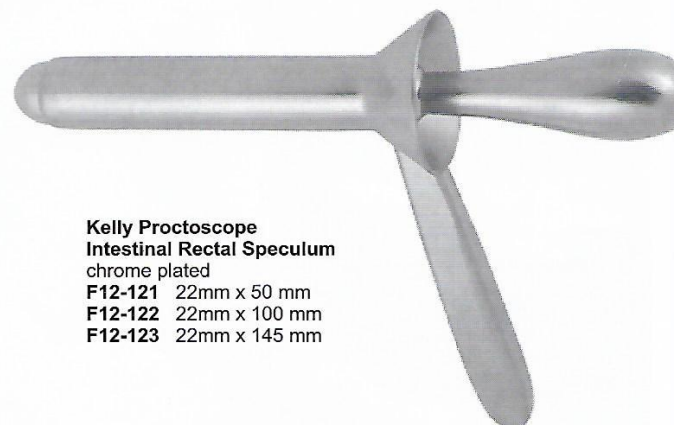

**Kelly Proctoscope
Intestinal Rectal Speculum**
chrome plated
F12-121 22mm x 50 mm
F12-122 22mm x 100 mm
F12-123 22mm x 145 mm



GYNECOLOGY / OBSTETRICS



VAGINAL SPECULUM



Scheidenspekula
Spéculums vaginaux

Espéculos vaginales
Specoli vaginali



Cusco vaginal speculum
F13-001 75 mm x 32 mm
F13-002 85 mm x 35 mm
F13-003 100 mm x 35 mm
F13-004 75 mm x 17 mm
for virgines



Cusco vaginal speculum
F13-005 75 mm x 32 mm
F13-006 80 mm x 35 mm
F13-007 100 mm x 37 mm



Cusco vaginal speculum
F13-008 80 mm x 22 mm
F13-009 100 mm x 25 mm
F13-010 105 mm x 27 mm
Swiss pattern



Grave vaginal speculum
F13-011 75 mm x 20 mm
F13-012 95 mm x 35 mm
F13-013 115 mm x 35 mm



Collin vaginal speculum
F13-014 85 mm x 30 mm
F13-015 100 mm x 35 mm
F13-016 110 mm x 40 mm



Semm vaginal speculum
F13-017 90 mm x 14 / 18 mm
F13-018 100 mm x 17 / 20 mm
F13-019 110 mm x 25 / 30 mm



VAGINAL SPECULUM

Scheidenspekula
Spéculums vaginaux

Espécules vaginales
Specoli vaginali



Graves Vaginal Speculum
F13-020 Small 2.2 cm 7/8" Blade
F13-021 Medium 3.5 cm 1 3/8" Blade
F13-022 Large 3.7 cm 1 1/2" Blade



Trelat vaginal speculum
F13-023 85 mm x 30 mm
F13-024 95 mm x 35 mm
F13-025 115 mm x 43 mm



Collin vaginal speculum
F13-025A Virgin
F13-025B Small
F13-025C Medium
F13-025D Large



Pederson vaginal speculum
F13-026 75 mm x 13 mm
F13-027 100 mm x 22 mm
F13-028 120 mm x 25 mm



Graves Vaginal Speculum Leep / Lietz
F13-029 Small
F13-030 Medium
F13-031 Large
F13-032 X-large



Pederson Vaginal Speculum Leep / Lietz
F13-033 Small
F13-034 Medium
F13-035 Large
F13-036 X-large

VAGINAL SPECULUM



Scheidenspekula
Speculums vaginaux

Espéculos vaginales
Specoli vaginali

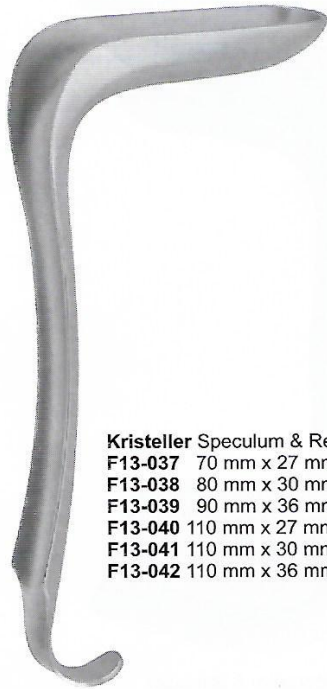

Kristeller Speculum & Retractor
F13-037 70 mm x 27 mm
F13-038 80 mm x 30 mm
F13-039 90 mm x 36 mm
F13-040 110 mm x 27 mm
F13-041 110 mm x 30 mm
F13-042 110 mm x 36 mm



**Kristeller Speculum
& Retractor**
F13-043 75 mm x 23 mm
F13-044 85 mm x 26 mm
F13-045 100 mm x 32 mm
F13-046 115 mm x 23 mm
F13-047 115 mm x 26 mm
F13-048 115 mm x 32 mm

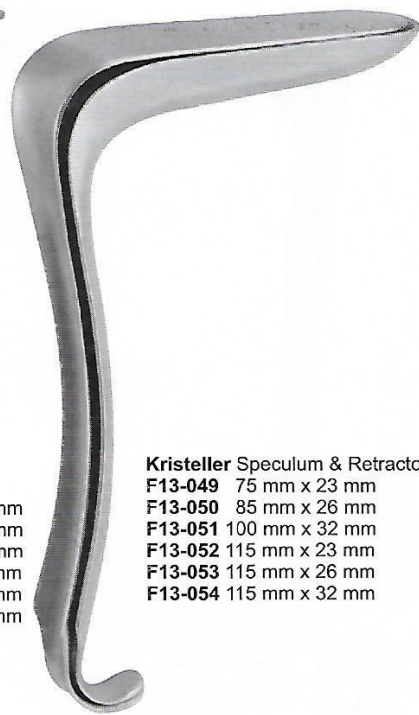

Kristeller Speculum & Retractor
F13-049 75 mm x 23 mm
F13-050 85 mm x 26 mm
F13-051 100 mm x 32 mm
F13-052 115 mm x 23 mm
F13-053 115 mm x 26 mm
F13-054 115 mm x 32 mm



Kristeller speculum & retractor
F13-055 105 mm x 18 mm
F13-056 105 mm x 21 mm
Speculum tapered, for virgins



Kristeller Speculum & Retractor
F13-057 110 mm x 14 mm
F13-058 115 mm x 17 mm



**Kristeller Speculum
& Retractor**
F13-059 110 mm x 14 mm
F13-060 115 mm x 17 mm



VAGINAL SPECULUM

Scheidenspekula | *Espéculos vaginales*
Spéculums vaginaux | *Specoli vaginali*



Jackson Speculum & Retractor
F13-061 75 mm x 35 mm
F13-062 75 mm x 40 mm
F13-063 90 mm x 35 mm
F13-064 90 mm x 40 mm
F13-065 100 mm x 35 mm
F13-066 100 mm x 40 mm



Sims Speculum & Retractor
F13-067 60 mm x 25 mm / 30 mm
F13-068 70 mm x 30 mm / 35 mm
F13-069 80 mm x 35 mm / 40 mm



**Kallmorgen Speculum
& Retractor**
F13-070 70 mm x 40 mm
F13-071 90 mm x 40 mm



**Kallmorgen Speculum
& Retractor**
F13-072 70 mm x 33 mm
F13-073 90 mm x 33 mm



**Kallmorgen Speculum
& Retractor**
F13-074 70 mm x 33 mm
F13-075 90 mm x 33 mm

VAGINAL SPECULUM



Scheidenspekula | Espéculos vaginales
 Spéculums vaginaux | Specoli vaginali



AUVARD,
 speculum & retractor
F13-076
 80 x 38 mm - 28 mm
 1,530 kg
 with fixed weight
 23 cm, 9"



AUVARD
 speculum & retractor
F13-077 75 x 42 mm
 (40 mm)
F13-078 105 x 43 mm
 (40 mm)
 with detachable weight
 23 cm, 9"



WEISSBARTH
 speculum & retractor
F13-079 80 x 28 mm
F13-080 85 x 42 mm
 21 cm, 8 1/4"



Garrigue Weighted Vaginal Speculum
F13-081 4.0 cm x 8.0 cm 1 5/8" x 3 1/8"
 Weight 2 lbs

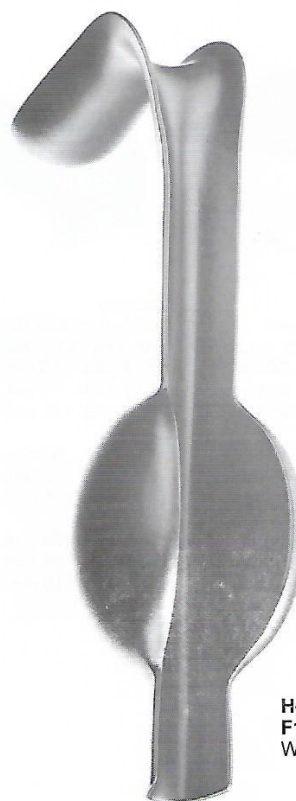

Henrotin Weighted Vaginal Speculum
F13-082 3.8 cm x 9.0 cm 1 1/2" x 3 1/2"
 Weight 3 lbs.



VAGINAL SPECULUM

Scheidenspekula
Spéculum vaginaux

Espéculos vaginales
Specoli vaginali



Landau speculum
29.0 cm 11 1/2"
F13-083 100 mm x 28 mm
F13-084 100 mm x 38 mm



Breisky speculum
30.0 cm 12"
F13-085 130 mm x 20 mm
F13-086 130 mm x 25 mm
F13-087 130 mm x 30 mm
F13-088 130 mm x 35 mm
F13-089 130 mm x 40 mm
Vienna pattern



Breisky speculum
30.0 cm 12"
F13-090 100 mm x 20 mm
F13-091 100 mm x 25 mm
F13-092 100 mm x 30 mm
F13-093 100 mm x 35 mm
F13-094 100 mm x 40 mm



Breisky speculum
35.0 cm 13 3/4"
F13-095 160 mm x 40 mm
F13-096 180 mm x 40 mm

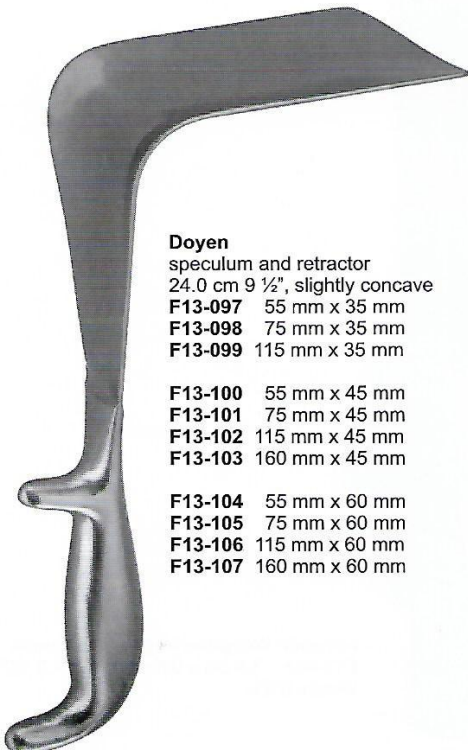

Doyen
speculum and retractor
24.0 cm 9 1/2", slightly concave
F13-097 55 mm x 35 mm
F13-098 75 mm x 35 mm
F13-099 115 mm x 35 mm

F13-100 55 mm x 45 mm
F13-101 75 mm x 45 mm
F13-102 115 mm x 45 mm
F13-103 160 mm x 45 mm

F13-104 55 mm x 60 mm
F13-105 75 mm x 60 mm
F13-106 115 mm x 60 mm
F13-107 160 mm x 60 mm



Doyen
speculum and retractor
24.0 cm 9 1/2", medium concave
F13-108 55 mm x 35 mm
F13-109 75 mm x 35 mm
F13-110 115 mm x 35 mm

F13-111 55 mm x 45 mm
F13-112 75 mm x 45 mm
F13-113 115 mm x 45 mm

F13-114 55 mm x 60 mm
F13-115 75 mm x 60 mm
F13-116 115 mm x 60 mm

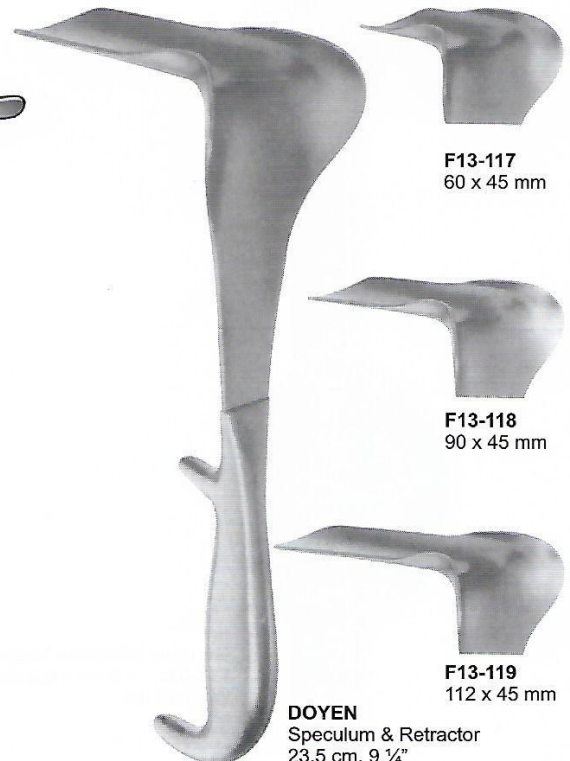

F13-117 60 x 45 mm

F13-118 90 x 45 mm

F13-119 112 x 45 mm

DOYEN
Speculum & Retractor
23.5 cm, 9 1/4"

VAGINAL SPECULUM



Scheidenspekula
Spéculums vaginaux

Espéculos vaginales
Specoli vaginali



**Scherback Speculum
F13-120**
Set consisting of:
handle weight 5 blades



F13-121
80 x 30 mm

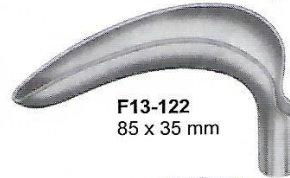

F13-122
85 x 35 mm

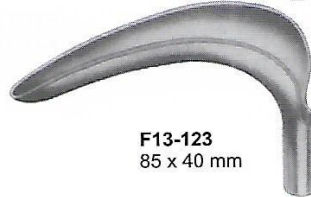

F13-123
85 x 40 mm



F13-124
55 x 40 - 60 mm



F13-125
70 x 45 - 70 mm

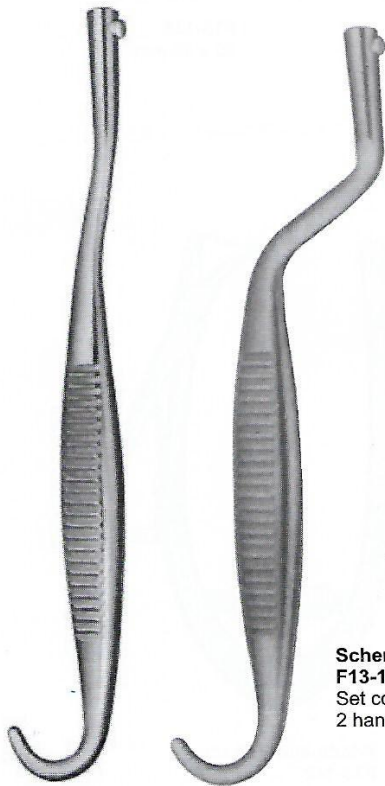

**Scherback Speculum
F13-126**
Set consisting of:
2 handle, 8 blades

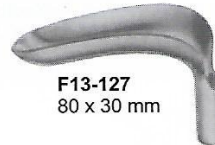

F13-127
80 x 30 mm



F13-131
65 x 30 mm

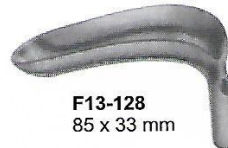

F13-128
85 x 33 mm



F13-132
75 x 35 mm

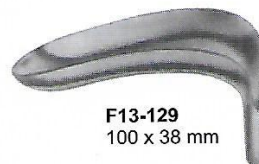

F13-129
100 x 38 mm



F13-133
85 x 35 mm

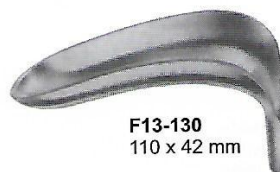

F13-130
110 x 42 mm



F13-134
95 x 35 mm



VAGINAL SPECULUM

Scheidenspekula

Espéculos vaginales

Spéculums vaginaux

Specoli vaginali



O'Sullivan - O'Connor
Vaginal Retractor
F13-135 Set of 3 Complete



F13-136
45 x 17 mm



F13-137
90 x 37 mm



F13-138
90 x 45 mm



Abdominal Retractor
F13-139 9 cm, 3 1/2" wide
F13-140 10 cm, 4" wide
F13-141 11.5 cm, 4 1/2" wide

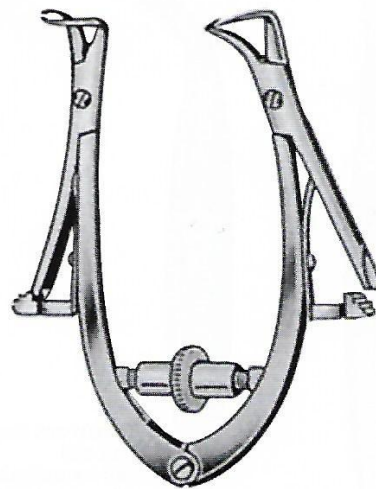

Friedmann Retractor
F13-142
10 cm, 4"

VAGINAL SPECULUM



Scheidenspekula
Spéculums vaginaux

Espéculos vaginales
Specoli vaginali

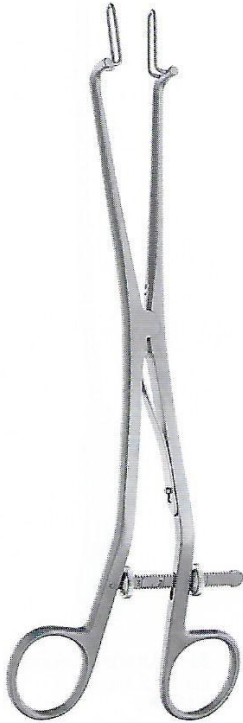

**Kogan speculum
F13-143**
24 cm, 9 1/2"
with scale-ratchet
and fixation screw

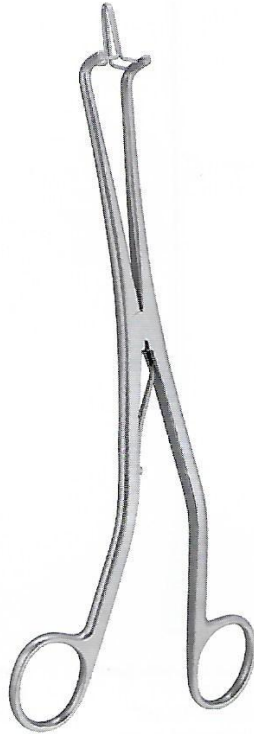

**Kogan speculum
F13-144**
24 cm, 9 1/2"



**Kogan - Modif.
speculum
F13-145**
28 cm, 11"
x=4 mm y=8mm
F13-146
x=2 mm y=4mm



**Lateral Nonconductive
Vaginal Retractor
F13-147** 6.3 cm wide



**McGee Lateral
Vaginal Retractor
With Ratchet Handle
F13-148** 20cm, 8"



UTERINE SOUNDS

Uterus-Sonden

Hystéromètres du col de l'utérus

Histerómetros uterinos

Isterometri uterini



**Sims Uterine Sound
F13-149**
33 cm, 13"
right, malleable



**Sims Uterine Sound
F13-150**
32.5cm 12 3/4"
Non-graduated



**Sims Uterine Sound
F13-151**
32.5cm 12 3/4"
Graduated in cm



**Sims-Special Uterine
Sound
F13-152** 33 cm, 13"



**Sims Uterine Sound
schwed. Modell
F13-153**
26 cm, 10 1/4"



**Martin Uterine Sound
F13-154** 30 cm, 12"



**Valleix Uterine Sound
F13-155** 25 cm, 10"

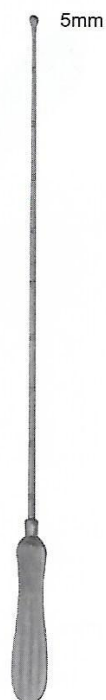

**Mayo Uterine Sound
F13-156** 33 cm 13"
biegam malleable



**Simpson Uterine Sound
F13-157** 29 cm 11 1/2"
malleable silver-plated



**Simpson Uterine Sound
F13-158** 32.5cm 12 3/4"
Graduated in inches

UTERINE SOUNDS



Uterus-Sonden

Histerómetros uterinos

Hystéromètres du col de l'utérus

Isterometri uterini



Hegar Uterine Dilator single ended

F13-159	1.0mm Ø	F13-179	11.5mm Ø	F13-199	23.0mm Ø
F13-160	1.5mm Ø	F13-180	12.0mm Ø	F13-200	24.0mm Ø
F13-161	2.0mm Ø	F13-181	12.5mm Ø	F13-201	25.0mm Ø
F13-162	2.5mm Ø	F13-182	13.0mm Ø	F13-202	26.0mm Ø
F13-163	3.0mm Ø	F13-183	13.5mm Ø	F13-203	27.0mm Ø
F13-164	3.5mm Ø	F13-184	14.0mm Ø	F13-204	28.0mm Ø
F13-165	4.0mm Ø	F13-185	14.5mm Ø	F13-205	29.0mm Ø
F13-166	4.5mm Ø	F13-186	15.0mm Ø	F13-206	30.0mm Ø
F13-167	5.0mm Ø	F13-187	15.5mm Ø		
F13-168	6.0mm Ø	F13-188	16.0mm Ø		
F13-169	6.5mm Ø	F13-189	16.5mm Ø		
F13-170	7.0mm Ø	F13-190	17.0mm Ø		
F13-171	7.5mm Ø	F13-191	17.5mm Ø		
F13-172	8.0mm Ø	F13-192	18.0mm Ø		
F13-173	8.5mm Ø	F13-193	18.5mm Ø		
F13-174	9.0mm Ø	F13-194	19.0mm Ø		
F13-175	9.5mm Ø	F13-195	19.5mm Ø		
F13-176	10.0mm Ø	F13-196	20.0mm Ø		
F13-177	10.5mm Ø	F13-197	21.0mm Ø		
F13-178	11.0mm Ø	F13-198	22.0mm Ø		

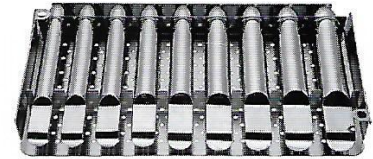

Hegar Uterine Dilator single ended

F13-207 4 mm - 17 mm Ø
8 Pieces per set
F13-208 1 mm - 26 mm Ø
24 Pieces per set

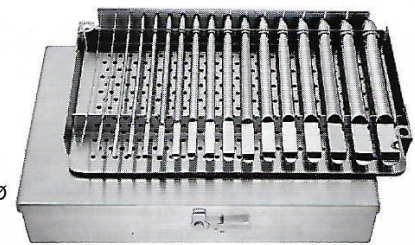

Hegar Uterine Dilator single ended

F13-209 4 mm - 17 mm Ø
24 pieces per set



Hegar uterine dilator

F13-210	1 / 2 mm Ø
F13-211	3 / 4 mm Ø
F13-212	5 / 6 mm Ø
F13-213	7 / 8 mm Ø
F13-214	9 / 10 mm Ø
F13-215	11 / 12 mm Ø
F13-216	13 / 14 mm Ø
F13-217	15 / 16 mm Ø
F13-218	17 / 18 mm Ø
F13-219	19 / 20 mm Ø
F13-220	21 / 22 mm Ø
F13-221	23 / 24 mm Ø
F13-222	25 / 26 mm Ø

double ended



Hegar uterine dilator

F13-223 3 / 4 mm - 17 / 18 mm Ø
8 Pieces per set
F13-224 1 / 2 mm - 25 / 26 mm Ø
14 Pieces per set





UTERINE SOUNDS

Uterus-Sonden

Histerómetros uterinos

Hystéromètres du col de l'utérus

Isterometri uterini



Hegar Uterine Dilator, Double-ended

- F13-225 3mm & 4mm, 7 7/8" (20cm)
- F13-226 5mm & 6mm, 7 7/8" (20cm)
- F13-227 7mm & 8mm, 7 7/8" (20cm)
- F13-228 9mm & 10mm, 7 7/8" (20cm)
- F13-229 11mm & 12mm, 7 7/8" (20cm)
- F13-230 13mm & 14mm, 7 7/8" (20cm)
- F13-231 15mm & 16mm, 7 7/8" (20cm)
- F13-232 17mm & 18mm, 7 7/8" (20cm)



Hegar Uterine Dilators 8 Set W/Roll

- F13-233 Complete Set
- Curved, Delicate, 3mm to 18mm, Curved



Hank Dilator

- F13-234 Fig. 19 / 10 4.5 / 5.0 mm Ø
- F13-235 Fig. 11 / 12 5.5 / 6.0 mm Ø
- F13-236 Fig. 13 / 14 6.5 / 7.0 mm Ø
- F13-237 Fig. 15 / 16 7.5 / 8.0 mm Ø
- F13-238 Fig. 17 / 18 8.5 / 9.0 mm Ø
- F13-239 Fig. 19 / 20 9.5 / 10.0 mm Ø

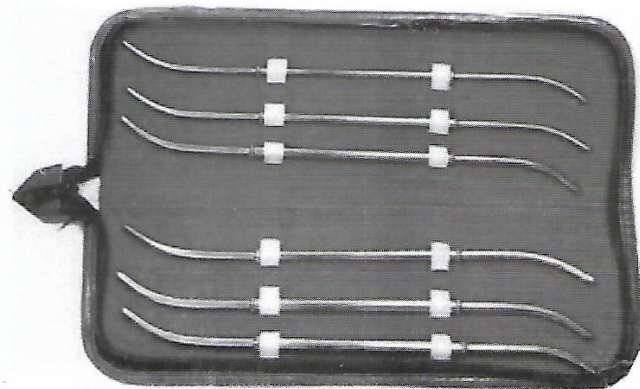

Hank Dilator set

- F13-240 Fig. 4.5 / 5 mm - 9.5 / 10.0 mm Ø
- 6 Pieces per set

PARAMETRIUM FORCEPS, HYSTERECTOMY FORCEPS



Parametriumklemmen, Hysterektomieklemmen
Pincas parametrium, Pincas à hystérectomie

Pinzas parametrium, Pinzas-clamps para histerectomia
Pinze parametrium, Pinze per isterectomia

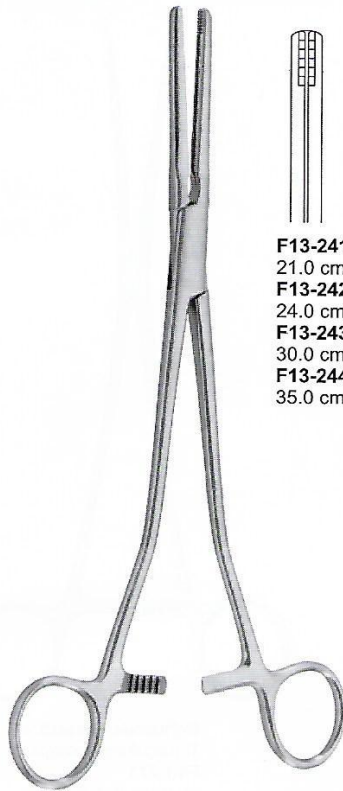

**Parametrium
Hysterectomy
Forceps**

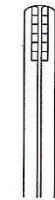

F13-241

21.0 cm 8 1/4"

F13-242

24.0 cm 9 1/2"

F13-243

30.0 cm 12"

F13-244

35.0 cm 13 3/4"

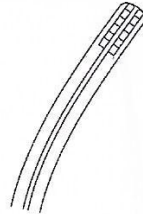

F13-245

21.0 cm 8 1/4"

F13-246

24.0 cm 9 1/2"

F13-247

30.0 cm 12"

F13-248

35.0 cm 13 3/4"

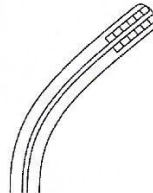

F13-249

21.0 cm 8 1/4"

F13-250

24.0 cm 9 1/2"

F13-251

30.0 cm 12"

F13-252

35.0 cm 13 3/4"

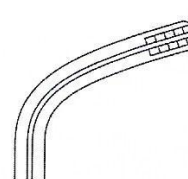

F13-253

21.0 cm 8 1/4"

F13-254

24.0 cm 9 1/2"

F13-255

30.0 cm 12"

F13-256

35.0 cm 13 3/4"

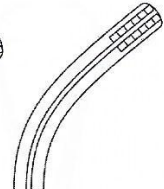

F13-257

21.0 cm 8 1/4"

F13-258

24.0 cm 9 1/2"

F13-259

30.0 cm 12"

F13-260

35.0 cm 13 3/4"

S-curved

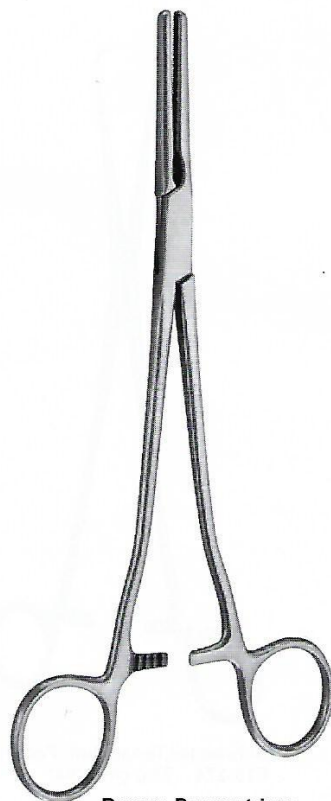

**Rogers Parametrium
Hysterectomy Forceps**

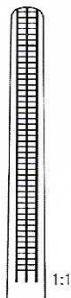

F13-261

Fig. 1

22.0 cm 8 3/4"

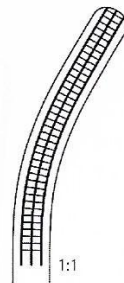

F13-262

Fig. 2

21.5 cm 8 1/2"

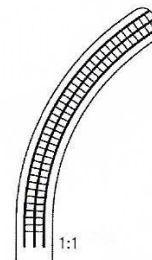

F13-263

Fig. 3

21.0 cm 8 1/4"

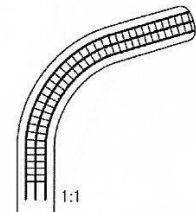

F13-264

Fig. 4

20.5 cm 8"

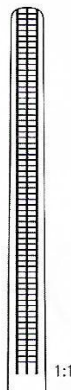

F13-265

Fig. 1

25.0 cm 9 3/4"

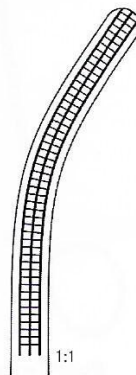

F13-266

Fig. 2

25.0 cm 9 3/4"

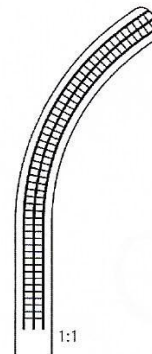

F13-267

Fig. 3

24.5 cm 9 1/2"

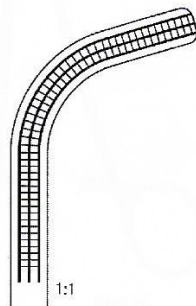

F13-268

Fig. 4

23.0 cm 9"



TENACULUM FORCEPS

Hakenzangen

Pinces pour l'abaissement du col de l'utérus

Pinzas para coger el cuello del útero

Pinze per abbassare il collo dell'utero

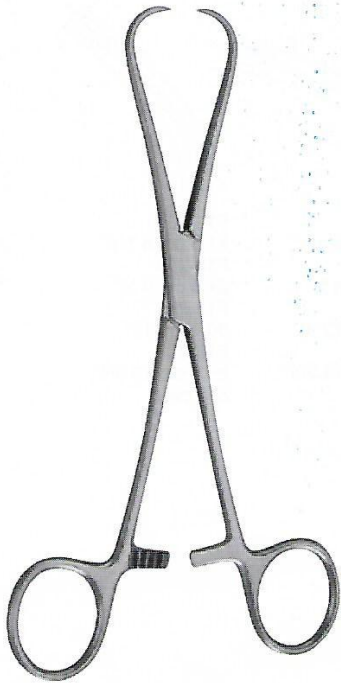

Staudé - Moore
Tenaculum Forceps
F13-269
17.0 cm 6 3/4"



Barrett
Tenaculum Forceps
F13-270
18.0 cm 7"

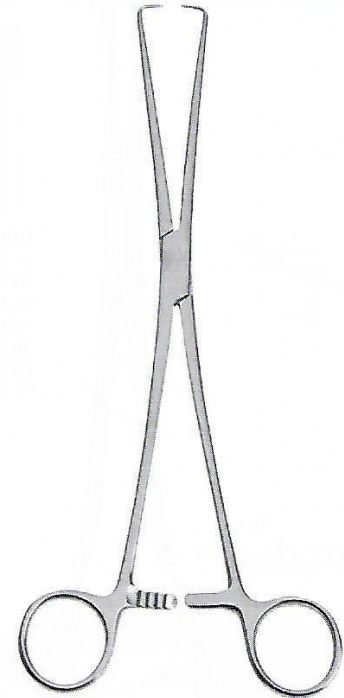

Schroeder-Braun
Tenaculum Forceps
F13-271
25.0 cm 9 3/4"

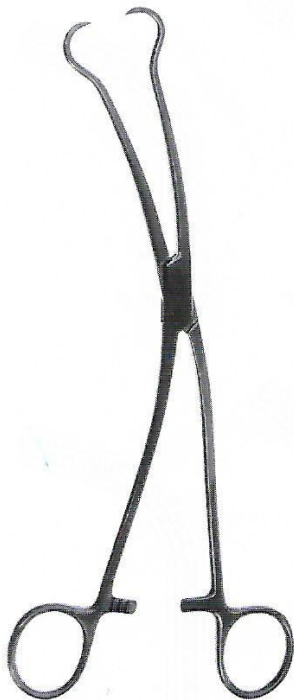

Skene
Tenaculum Forceps
F13-272
24.0 cm 9 1/2"

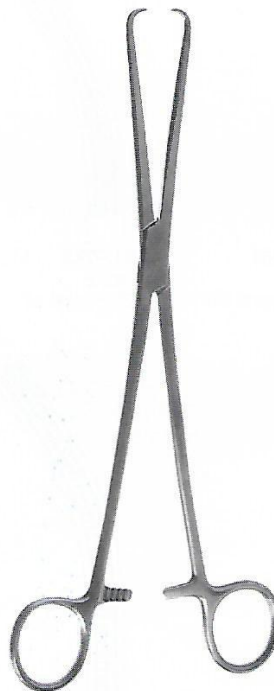

Pozzi Tenaculum Forceps
F13-273 25.5 cm 10"



Schroeder Tenaculum Forceps
F13-274 25.0 cm 9 3/4"

TENACULUM FORCEPS



Hakenzangen

Pinzas para coger el cuello del útero

Pinces pour l'abaissement du col de l'utérus

Pinze per abbassare il collo dell'utero

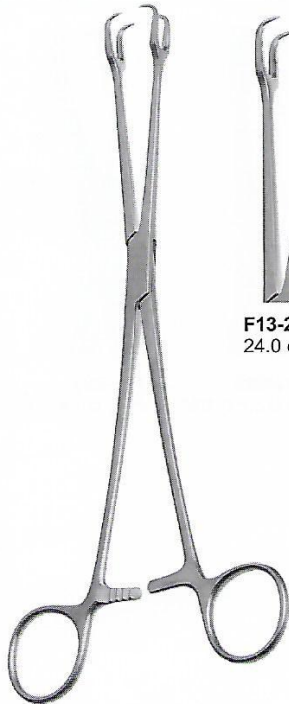

**Schroeder Vulsellum
Tenaculum Forceps**

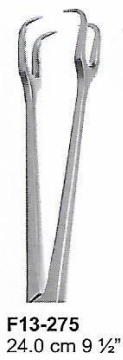

F13-275
24.0 cm 9 1/2"

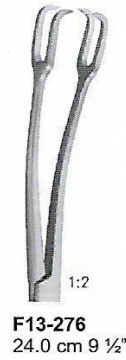

F13-276
24.0 cm 9 1/2"



**Duplay Tenaculum
Forceps**
F13-277 28.0 cm 11"

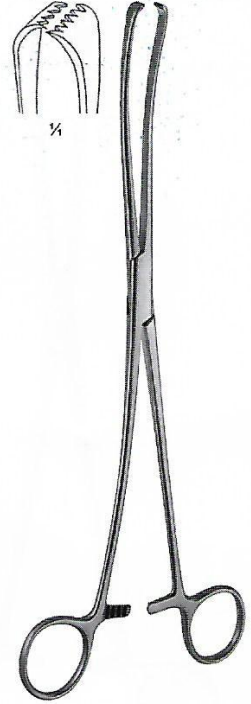

Iowa Tenaculum Forceps
F13-278 26.0 cm 10 1/4"



Beacham Amniotome
F13-279 26.0 cm 10 1/4"

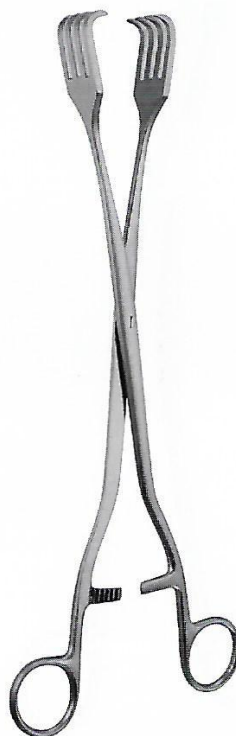

Pratt Tenaculum Forceps
F13-280
26.0 cm 10 1/4"



Czerny Tenaculum Forceps
F13-281
20.5 cm 8"



TENACULUM FORCEPS

Hakenzangen

Pinces pour l'abaissement du col de l'utérus

Pinzas para coger el cuello del útero

Pinze per abbassare il collo dell'utero

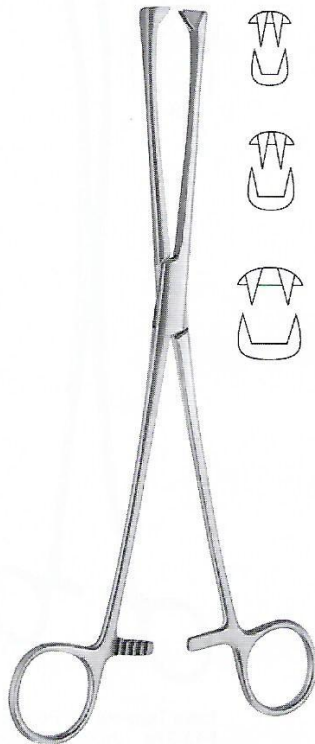

Museux Tenaculum Forceps

F13-282 8 mm
F13-283 6 mm
F13-284 10 mm
24.0 cm 9 1/2"



F13-285 8 mm
F13-286 6 mm
F13-287 10 mm
24.0 cm 9 1/2"

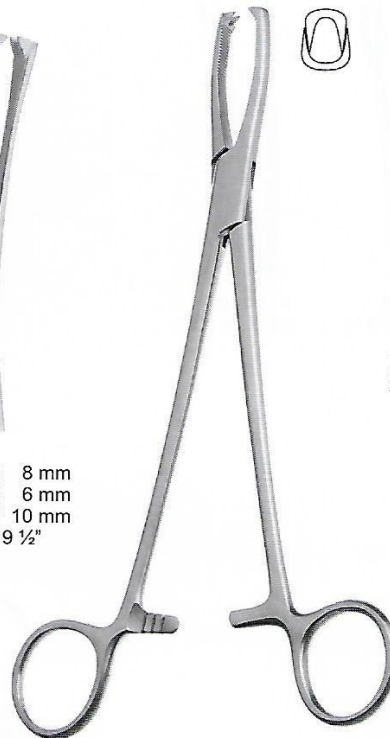

Jacobs Uterine Vulsellum Forceps

F13-288
21.0 cm 8 1/4"



F13-289
21.0 cm 8 1/4"



Teale Tenaculum Forceps
F13-290
23.0 cm 9"

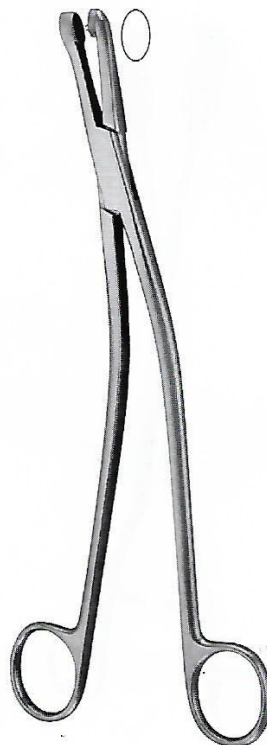

Gellhorn Biopsy Forceps
F13-291
23.0 cm 9"



Thoms-Gaylor Biopsy Forceps
F13-292 22.0 cm 8 3/4"
F13-293 24.0 cm 9 1/2"

CERVICAL BIOPSY AND SPECIMEN FORCEPS



Probeexzisionszangen

Pinzas saca-bocados para biopsia

Pinces emporte-pièces à biopsie

Pinze taglianti per biopsia



Schubert Biopsy Forceps
F13-294 21.0 cm 8 1/2"
F13-295 28.0 cm 11"



Faure Uterine Biopsy Forceps
F13-296 21.0 cm 8 1/2"



Schubert Biopsy Forceps
F13-297
 26.0 cm 10 1/4"



Van Doren Biopsy Forceps
F13-298
 24.0 cm 9 1/2"



Schumacher Biopsy Forceps

1:1
 Fig. 1
F13-299
 24.0 cm 9 1/2"

1:1
 Fig. 2
F13-300
 24.0 cm 9 1/2"



CERVICAL BIOPSY AND SPECIMEN FORCEPS

Probeexzisionszangen

Pinzas saca-bocados para biopsia

Pinces emporte-pièces à biopsie

Pinze taglianti per biopsia

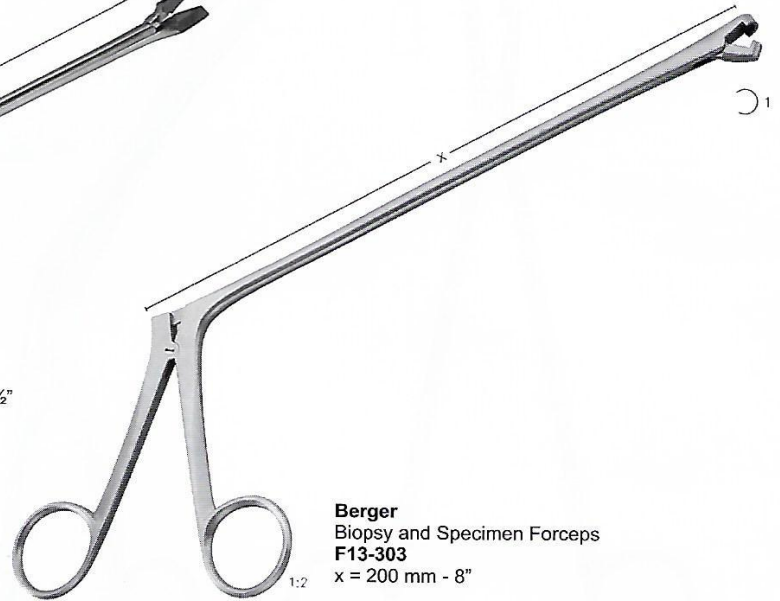
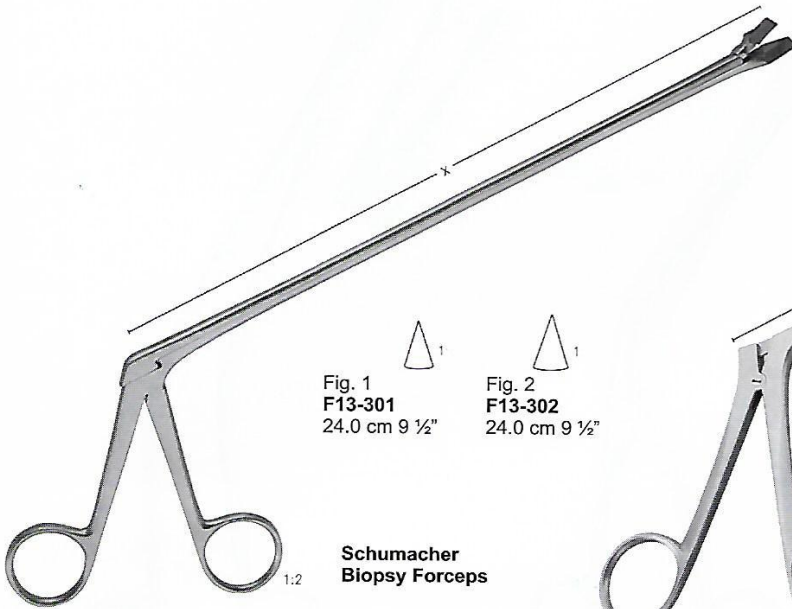

Eppendorfer
Biopsy and Specimen Forceps
F13-304
x = 200 mm - 8"

Kevorkian
Biopsy and Specimen Forceps
F13-305
x = 245 mm - 9 3/4"

CERVICAL BIOPSY AND SPECIMEN FORCEPS



Probeexzisionszangen

Pinzas saca-bocados para biopsia

Pinces emporte-pièces à biopsie

Pinze taglianti per biopsia

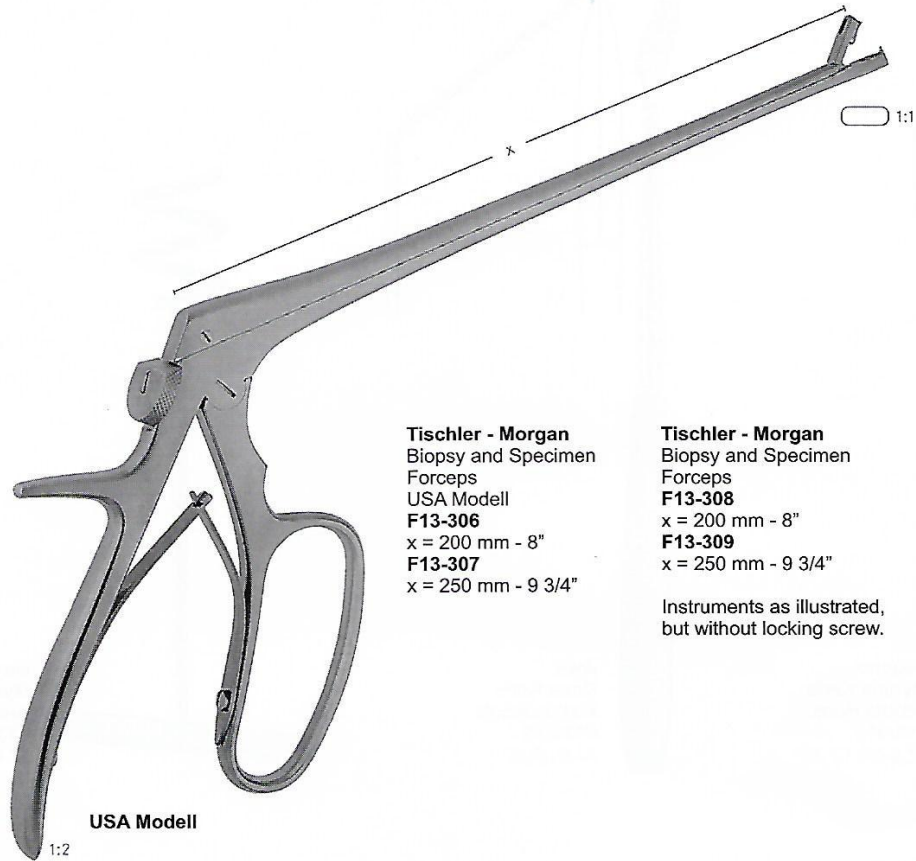

Tischler - Morgan
Biopsy and Specimen
Forceps
USA Modell
F13-306
x = 200 mm - 8"
F13-307
x = 250 mm - 9 3/4"

Tischler - Morgan
Biopsy and Specimen
Forceps
F13-308
x = 200 mm - 8"
F13-309
x = 250 mm - 9 3/4"

Instruments as illustrated,
but without locking screw.

USA Modell

1:2

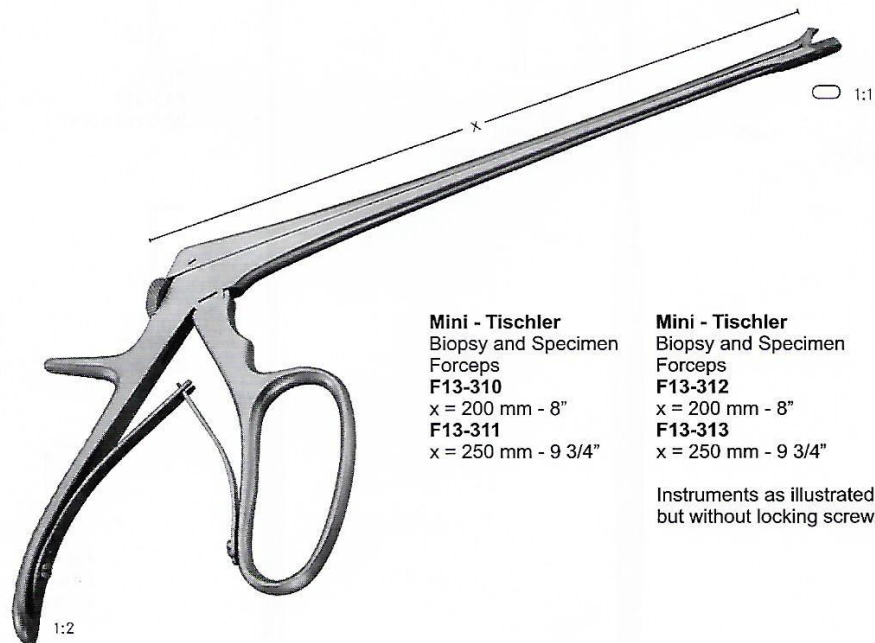

Mini - Tischler
Biopsy and Specimen
Forceps
F13-310
x = 200 mm - 8"
F13-311
x = 250 mm - 9 3/4"

Mini - Tischler
Biopsy and Specimen
Forceps
F13-312
x = 200 mm - 8"
F13-313
x = 250 mm - 9 3/4"

Instruments as illustrated,
but without locking screw.

1:2



MYOMA INSTRUMENTS, FISTULA HOOKS

Myom-Instrumente, Fistelhaken

Instrumentos para fibroma, Ganchos para fistulas

Instruments pour myomes, Crochets pour fistules

Strumenti per miomi, Uncini per fistole

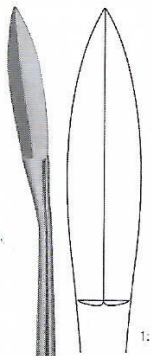

**Segond
Myoma Knife
Fistula Hook
F13-314**
27.0 cm 10 3/4"

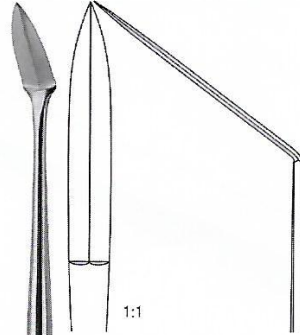

**Ayre
Cone Knife
Fistula Hook
F13-315**
23.0 cm 9"



**Doyen
Myoma Screw
And Fistula Hook
F13-316**
17.0 cm 6 3/4"

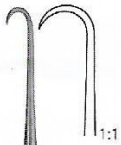

**Fig. 1
F13-317**
22.0 cm 8 3/4"

**Simon
Fistula Hook,
One Prong**

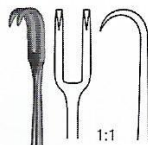

**Fig. 2
F13-318**
22.0 cm 8 3/4"

**Simon
Fistula Hook,
Two Prong**



**Fig. 1
F13-319**
22.0 cm 8 3/4"

**Emmet
Fistula Hook**



**Fig. 2
F13-320**
22.0 cm 8 3/4"



**Fig. 3
F13-321**
22.0 cm 8 3/4"



**Fig. 4
F13-322**
22.0 cm 8 3/4"



**Fig. 5
F13-323**
22.0 cm 8 3/4"

BIOPSY CURETTES, ASPIRATING CURETTES



Biopsieküretten, Absaugküretten

Curetas de aspiración

Curettes pour biopsie, Curettes d'aspiration

Curette per aspirazione



Uni - Randall
aspirating curette
F13-324 4 mm Ø
24.0 cm 9 1/2"

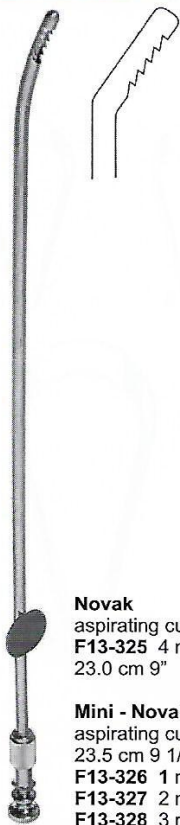

Novak
aspirating curette
F13-325 4 mm Ø
23.0 cm 9"

Mini - Novak
aspirating curette
23.5 cm 9 1/4"
F13-326 1 mm Ø
F13-327 2 mm Ø
F13-328 3 mm Ø



Uni - Randall
aspirating curette
F13-329
30.0 cm 12"
rigid, without basket

Uni - Randall
aspirating curette
F13-330
30.0 cm 12"
malleable,
without basket



1:1

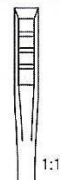

1:1

Uni - Randall
aspirating curette
F13-331
30.0 cm 12"
rigid, with basket

Uni - Randall
aspirating curette
F13-332
30.0 cm 12"
malleable,
with basket



Specimen And Aspirating Curette
20.0 cm 11 1/2"
F13-333 3 mm Ø
F13-334 4 mm Ø
F13-335 6 mm Ø
F13-336 8 mm Ø
F13-337 10 mm Ø
F13-338 12 mm Ø
F13-339 14 mm Ø

Coupling Piece
aspirating curette
12.0 cm 4 3/4"
F13-340



Braun Uterine Depressor
F13-341 28.0 cm 11"



Blake Double Ended
F13-342 245mm (9.3/4")
Sharp / Blunt



Zweifel Double Ended
F13-343 245mm (9.3/4")
Sharp / Sharp



UTERINE CURETTES

Uterusküretten | Curettes uterinas
Curettes utérines | Curette uterine

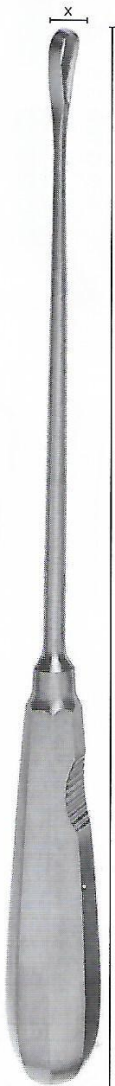
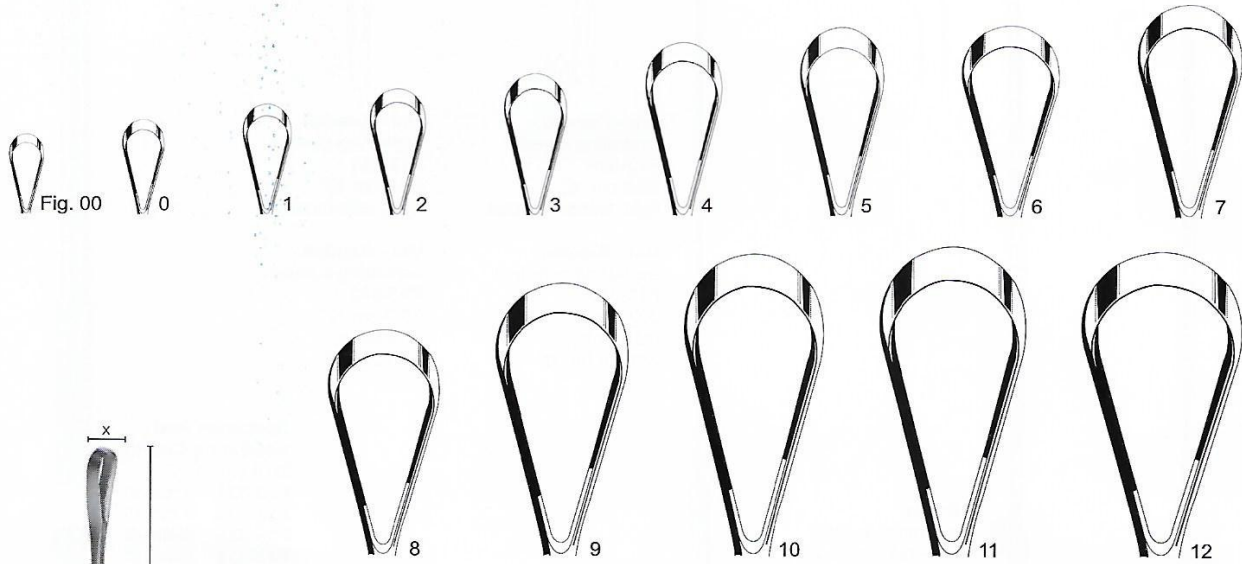

Recamier
uterine curette
y=26.0 cm 10 1/4"

Fig.	x=mm	Sharp, malleable	Blunt, malleable	Sharp, rigid	Blunt, rigid
00	5	F13-344	F13-358	F13-372	F13-386
0	6	F13-345	F13-359	F13-373	F13-387
1	7	F13-346	F13-360	F13-374	F13-388
2	8	F13-347	F13-361	F13-375	F13-389
3	9	F13-348	F13-362	F13-376	F13-390
4	11	F13-349	F13-363	F13-377	F13-391
5	12	F13-350	F13-364	F13-378	F13-392
6	14	F13-351	F13-365	F13-379	F13-393
7	15	F13-352	F13-366	F13-380	F13-394
8	16	F13-353	F13-367	F13-381	F13-395
9	19	F13-354	F13-368	F13-382	F13-396
10	20	F13-355	F13-369	F13-383	F13-397
11	21	F13-356	F13-370	F13-384	F13-398
12	23	F13-357	F13-371	F13-385	F13-399

Recamier
uterine curette
y=31.0 cm 12 1/4"

Fig.	x=mm	Sharp, malleable	Blunt, malleable	Sharp, rigid	Blunt, rigid
00	5	F13-400	F13-414	F13-428	F13-442
0	6	F13-401	F13-415	F13-429	F13-443
1	7	F13-402	F13-416	F13-430	F13-444
2	8	F13-403	F13-417	F13-431	F13-445
3	9	F13-404	F13-418	F13-432	F13-446
4	11	F13-405	F13-419	F13-433	F13-447
5	12	F13-406	F13-420	F13-434	F13-448
6	14	F13-407	F13-421	F13-435	F13-449
7	15	F13-408	F13-422	F13-436	F13-450
8	16	F13-409	F13-423	F13-437	F13-451
9	19	F13-410	F13-424	F13-438	F13-452
10	20	F13-411	F13-425	F13-439	F13-453
11	21	F13-412	F13-426	F13-440	F13-454
12	23	F13-413	F13-427	F13-441	F13-455

UTERINE CURETTES



Uterusküretten | Currettes uterinas
Curettes utérines | Curette uterine

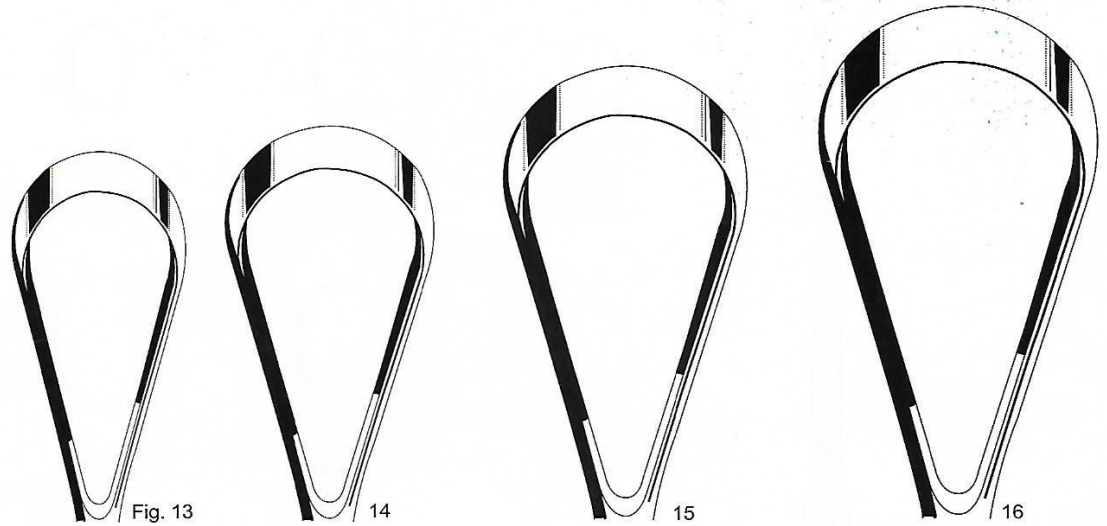

	Fig.	x=mm	Sharp, malleable	Blunt, malleable	Sharp, rigid	Blunt, rigid
Recamier uterine curette y=34.0 cm 13 1/2"	13	25	F13-456	F13-460	F13-464	F13-468
	14	30	F13-457	F13-461	F13-465	F13-469
	15	35	F13-458	F13-462	F13-466	F13-470
	16	40	F13-459	F13-463	F13-467	F13-471

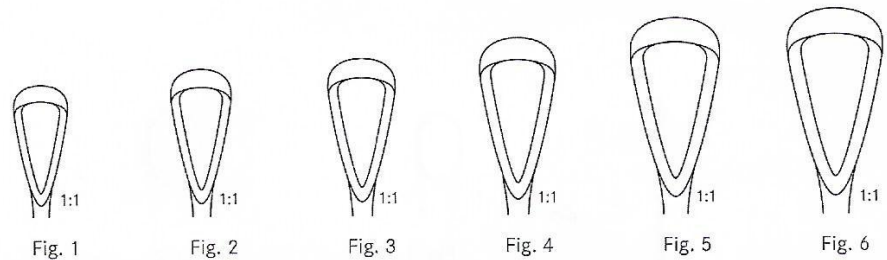

	Fig.	x=mm	Sharp, malleable	Blunt, malleable	Sharp, rigid	Blunt, rigid
Sims uterine curette 27.9 cm 11"	1	7	F13-472	F13-478	F13-484	F13-490
	2	8	F13-473	F13-479	F13-485	F13-491
	3	9	F13-474	F13-480	F13-486	F13-492
	4	11	F13-475	F13-481	F13-487	F13-493
	5	12	F13-476	F13-482	F13-488	F13-494
	6	14	F13-477	F13-483	F13-489	F13-495



UTERINE SPOONS

Scharfe Löffel

Curettes tranchantes

Cucharillas cortantes

Cucchiai tahlienti



Schröder
Uterine Spoon



Fig. 1
F13-496
25.0 cm 9 3/4"
Sharp, rigid



Fig. 2
F13-497
25.0 cm 9 3/4"
Sharp, rigid

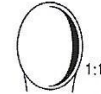

Fig. 3
F13-498
25.0 cm 9 3/4"
Sharp, rigid

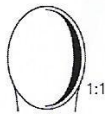

Fig. 4
F13-499
25.0 cm 9 3/4"
Sharp, rigid

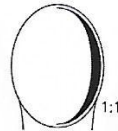

Fig. 5
F13-500
25.0 cm 9 3/4"
Sharp, rigid

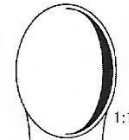

Fig. 6
F13-501
25.0 cm 9 3/4"
Sharp, rigid



Schröder
Uterine Spoon

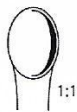

Fig. 1
F13-502
30.0 cm 12"



Fig. 2
F13-503
30.0 cm 12"

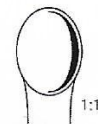

Fig. 3
F13-504
30.0 cm 12"



Fig. 4
F13-505
30.0 cm 12"

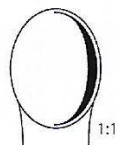

Fig. 5
F13-506
30.0 cm 12"

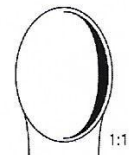

Fig. 6
F13-507
30.0 cm 12"

PELVIMETER, OBSTETRICAL FORCEPS



Beckenzirkel, Geburtszangen
Pelvimètre, Forceps obstétriques

Pelvímetro, Forceps obstétricos
Pelvimetri, Forcipi obstetrici

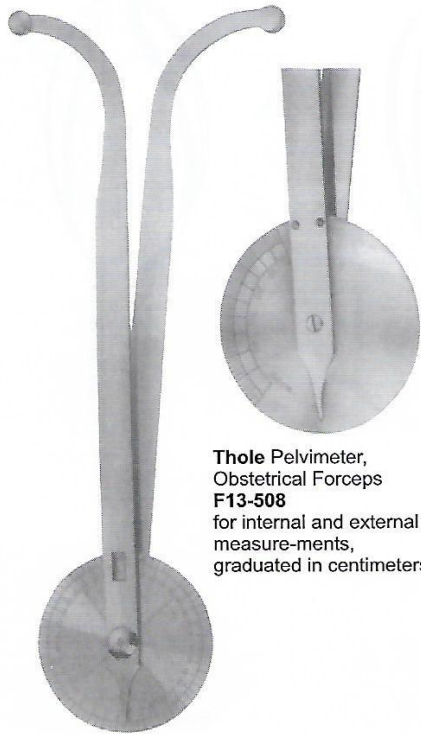

**Thole Pelvimeter,
Obstetrical Forceps
F13-508**
for internal and external measure-ments,
graduated in centimeters



**De Lee Pelvimeter,
Obstetrical Forceps
F13-509**
graduated in centimeters
and inches

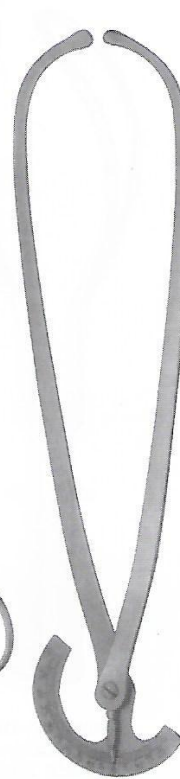

**Collin Pelvimeter,
Obstetrical Forceps
F13-510**
Graduated in
Centimeters



**Martin Pelvimeter,
Obstetrical Forceps
F13-511**
graduated in
centimeters

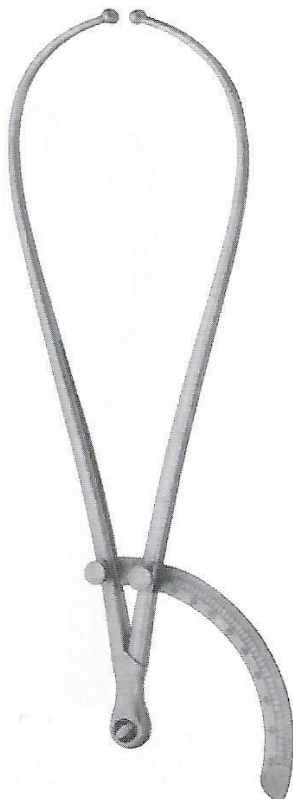

for internal measurements
between symphysis and
promontory

**Collin Pelvimeter,
Obstetrical Forceps
F13-512**
graduated in centimeters



The additional straight arm
can be replaced. The pelvimeter
with straight arm is used for
localisation of the portio vaginalis
uteri and of vaginal metastasis.



**Breisky Pelvimeter,
Obstetrical Forceps
F13-513**
graduated in
centimeters



OBSTETRICAL FORCEPS

Geburtszangen

Forceps obstétricos

Forceps obstétriques

Forcipi



Simpson
obstetrical forceps
F13-514
30.0 cm 12"



Simpson - Braun
obstetrical forceps
F13-515 33.0 cm 13"
F13-516 36.0 cm 14 1/4"

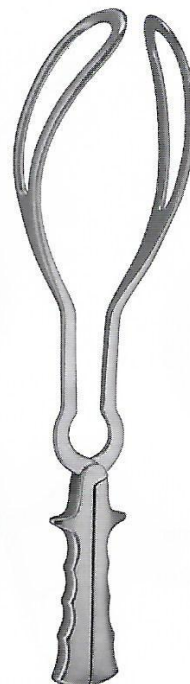

Naegele
obstetrical forceps
F13-517 36.0 cm 14 1/4"
F13-518 40.0 cm 16"



Piper
obstetrical forceps
F13-519
44.0 cm 17 1/4"



Simpson - Luikart
obstetrical forceps
F13-520
36.0 cm 14 1/4"



Wrigley
obstetrical forceps
F13-521 25.0 cm 9 3/4"
for caesarian section

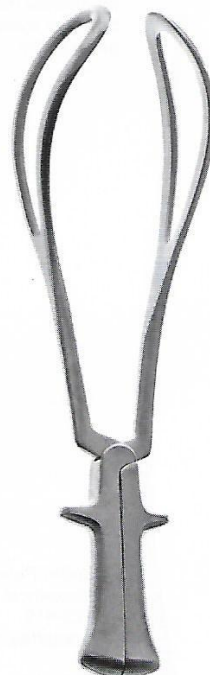

De Lee
obstetrical forceps
F13-522
30.0 cm 12"



De Lee
obstetrical forceps
F13-523 36.0 cm 14 1/4"
F13-524 15.0 cm 15 1/2"

OBSTETRICAL FORCEPS



Geburtszangen
Forceps obstétricus

Forceps obstétricos
Forcipi



Elliot
obstetrical forceps
F13-525 32.0 cm 12 1/2"
F13-526 38.0 cm 15"

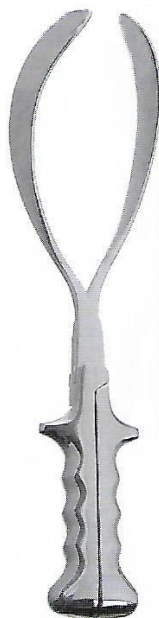

McLean
obstetrical forceps
F13-527 36.0 cm 14 1/4"



Kielland
obstetrical forceps
F13-528 41.0 cm 16 1/4"



Kielland-Luikart
obstetrical forceps
F13-529 40.0 cm 16"



Braun
obstetrical forceps
F13-530
42.0 cm 16 1/2"
Cranioclast, one
jaw fenestrated



Tarnier
obstetrical forceps
F13-531
46.0 cm 17 1/4"
Basiotribe



Sellheim
Obstetrical Lever
F13-532
28.0 cm 11"



OBSTETRICS

Geburtshilfe | obstetrica
obstétrique | Ostetricia

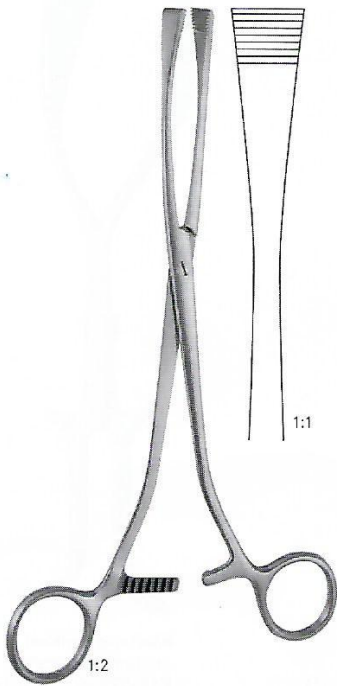

Green-Armytage
Uterine Elevating Forceps
F13-533 21.0 cm 8 1/4"

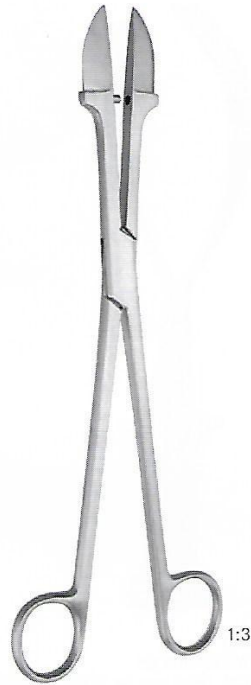

Smellie
Obstetrical Forceps
F13-534 25.0 cm 10"
Perforator

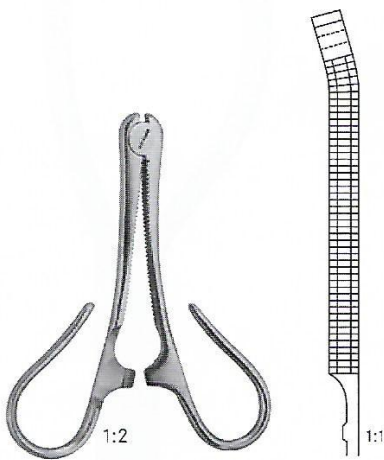

Kane
obstetrical forceps
F13-535
85.0 cm 3 1/4"



Collin
obstetrical forceps
F13-536
90.0 cm 3 1/2"



Braun, Midwifery
Decapitating hook
F13-537
32.5 cm 12 3/4"

ABORTION FORCEPS - OVUM CURETTES



Abortuszangen - Abortusküretten

Pinzas para abort - Curetas para aborto

Pinces à faux germes - Curette d'avortement

Pinze per placenta ed aborto - Curette per placenta ed aborto

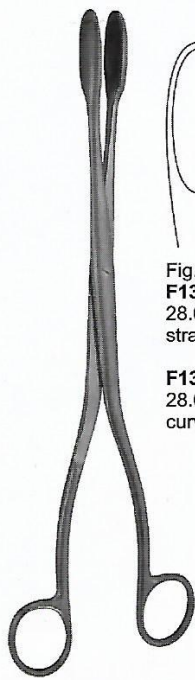

Winter
abortion forceps



Fig. 1
F13-538
28.0 cm 11"
straight

F13-539
28.0 cm 11"
curved



Fig. 2
F13-540
28.0 cm 11"
straight

F13-541
28.0 cm 11"
curved

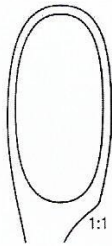
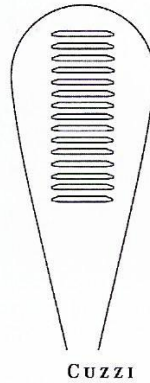

Fig. 3
F13-542
28.0 cm 11"
straight

F13-543
28.0 cm 11"
curved



Cuzzi
ovum curette
blunt, back serrated



C U Z Z I



14.5 mm
F13-544
30.0 cm 12"



18.0 mm
F13-545
30.0 cm 12"



21.0 mm
F13-546
30.0 cm 12"

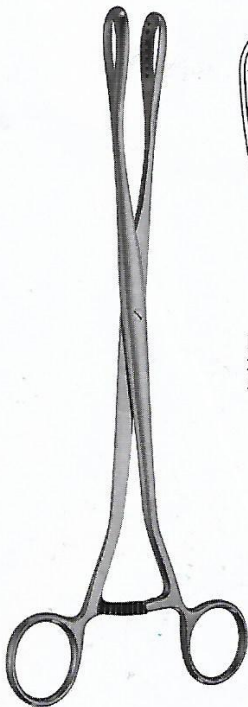

Saenger
abortion forceps

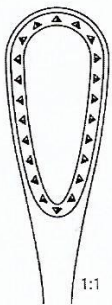

F13-547
27.0 cm 10 3/4"
Straight

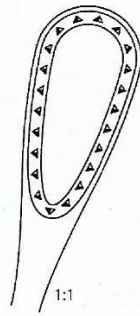

F13-548
27.0 cm 10 3/4"
Curved

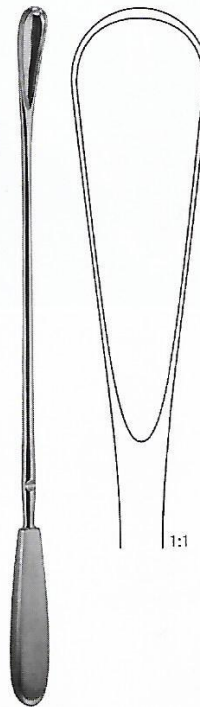

Wallich
ovum curette
F13-549 42.0 cm 16 1/2"

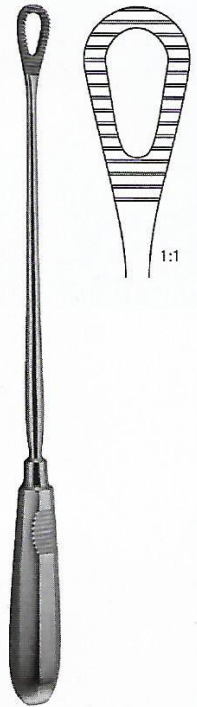

Pestalozza
ovum curette
F13-550 30.0 cm 12"



UROLOGY INSTRUMENTS

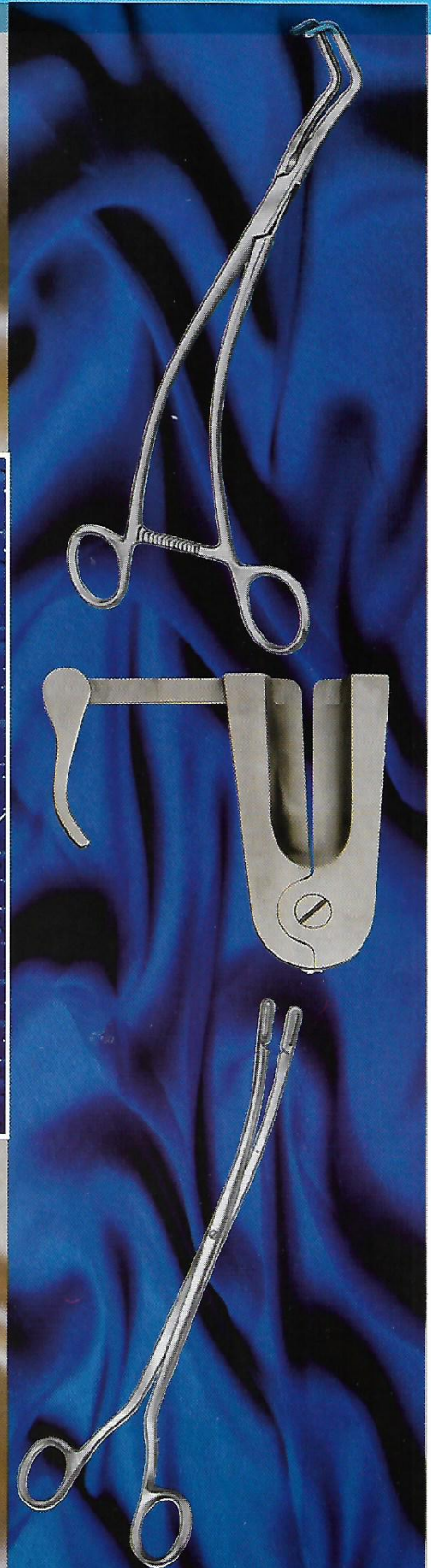
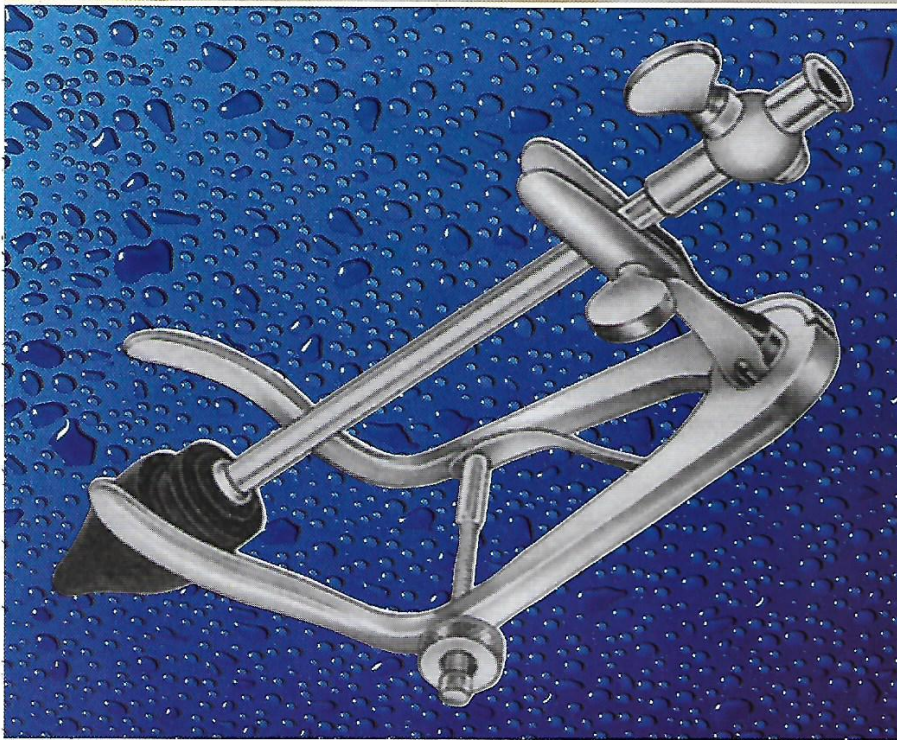

KIDNEY STONE FORCEPS



Nierensteinzangen

Pinces pour les calculs du bassin

Pinzas para cálculos renales

Pinze per calcoli renali

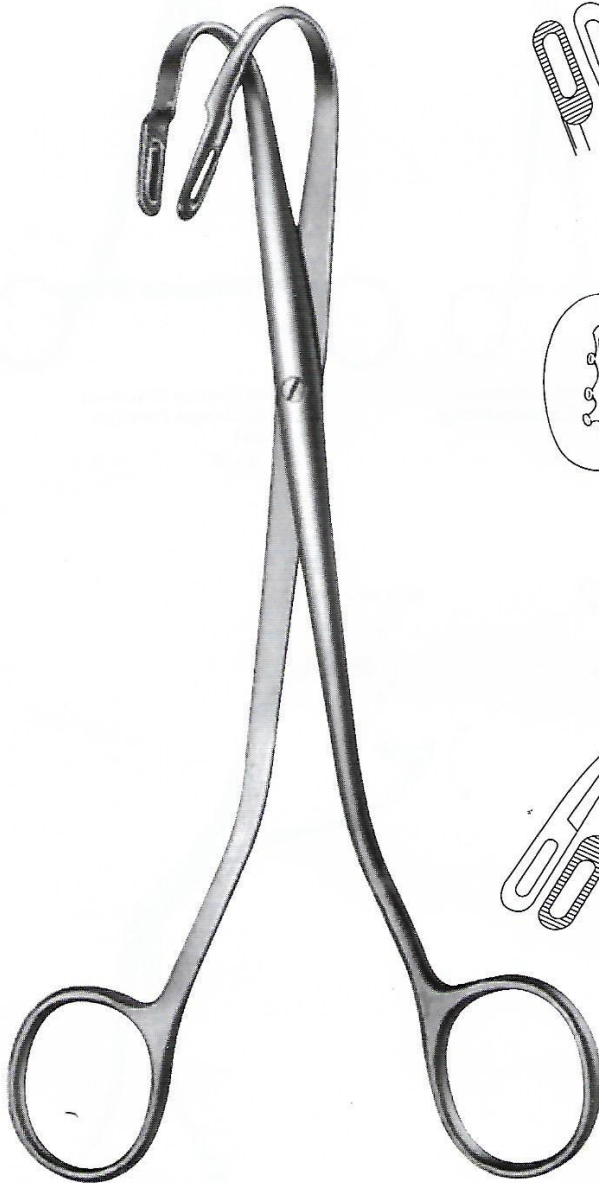

Randall Kidney Stone Clamps Forceps

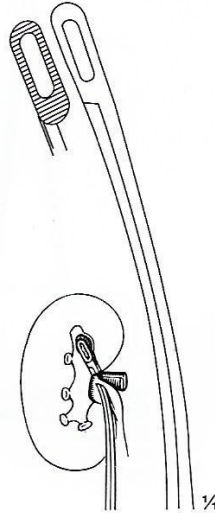

F14-001
23 cm, 9"
quarter curved

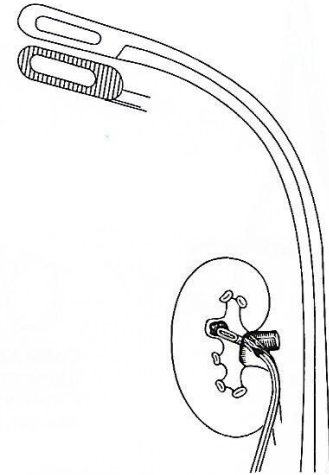

F14-002
23 cm, 9"
half curved

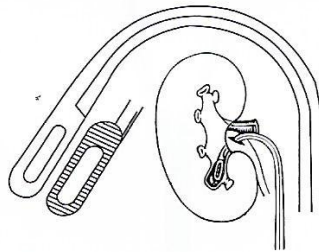

F14-003
23 cm, 9"
full curved

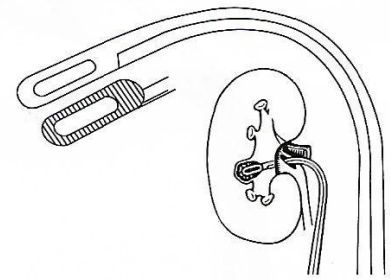

F14-004
23 cm, 9"
three quarter curved



KIDNEY STONE FORCEPS

Nierensteinzangen

Pinces pour les calculs du bassin

Pinzas para cálculoa renales

Pinze per calcoli renali

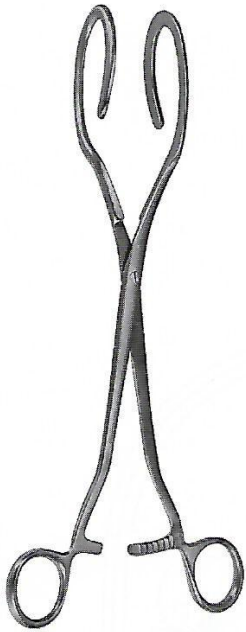

Dartigues Uterine Elevating Forceps
F14-005
27 cm, 10 3/4"



Collin Kidney Elevating Stone Clamps Forceps
F14-006
28.5 cm, 11 1/4"

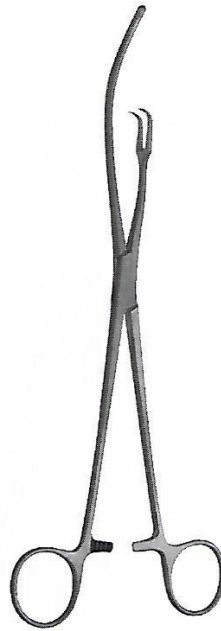

Hulka-Kenwick Uterine Elevating & Manipulating Forceps
F14-007
27.3 cm, 11"



Sommer Kidney Elevating Stone Clamps Forceps
F14-008
23.5 cm, 9"



Strassmann Kidney Elevating Stone Clamps Forceps
F14-009
26 cm, 10 1/4"

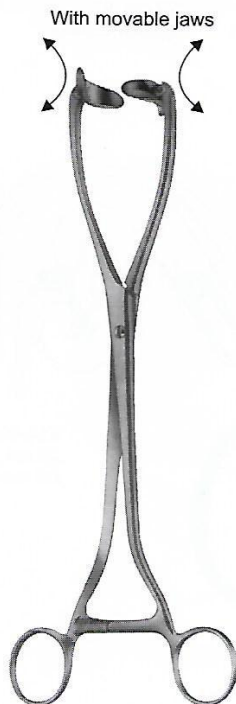

Collin Kidney Elevating Stone Clamps Forceps
F14-010
26.5 cm, 10 1/2"



Collin Kidney Elevating Stone Clamps Forceps
F14-011
26 cm, 10 1/4"

PROSTATIC RETRACTOR



Prostatahaken

Ecarteurs prostatiques

Separadores para próstata

Divaricatori prostatici

11 x 50 mm



**Young Prostatic Retractor
F14-012**
21 cm, 8 1/4" 11 x 50 mm

38 x 64 mm

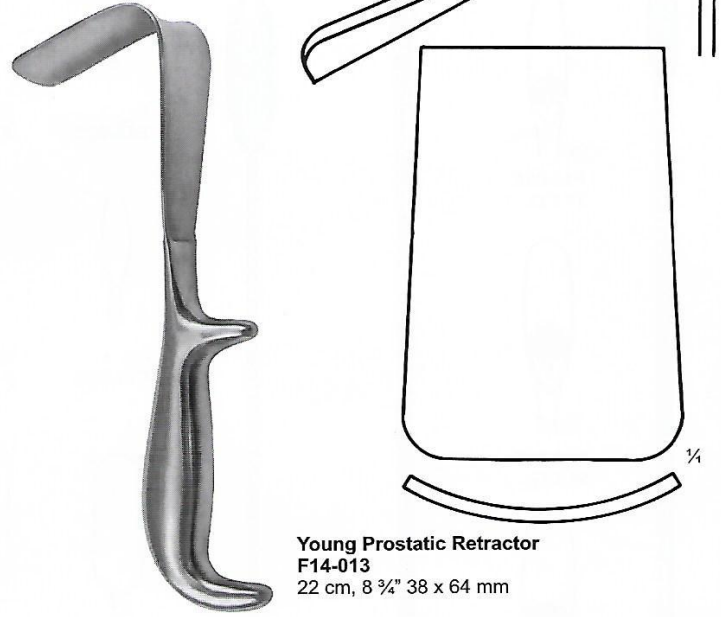

**Young Prostatic Retractor
F14-013**
22 cm, 8 3/4" 38 x 64 mm

25 x 25 mm

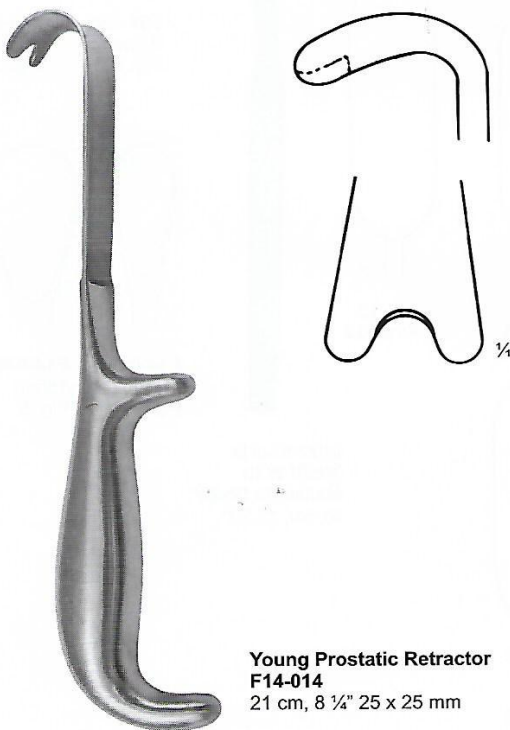

**Young Prostatic Retractor
F14-014**
21 cm, 8 1/4" 25 x 25 mm

39 x 35 mm

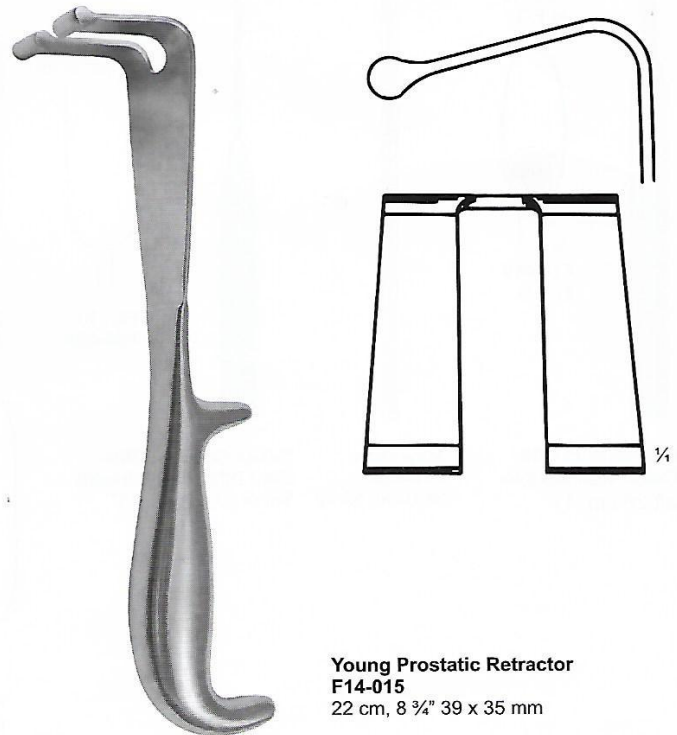

**Young Prostatic Retractor
F14-015**
22 cm, 8 3/4" 39 x 35 mm



GALL DUCT DILATOR

Gallenkanaldilatatoren
Gallensteinzangen

Dilatateurs pour les voies biliaires
Pincés pour calculs biliaires



F14-016
17 F.G.



F14-017
21 F.G.



F14-018
24 F.G.



F14-019
27 F.G.

**Desjardins Probe
& Catch with flexible
shaft 28 cm, 11"**



**Moynihan
F14-020
34.0 cm, 13 1/2"**



**Bakes Common Bile
Duct Dilators, Malleable
Set of 13, 32 cm, 13"**



Fig. 1
F14-021



Fig. 2
F14-022



Fig. 3
F14-023



Fig. 4
F14-024



Fig. 5
F14-025



Fig. 6
F14-026

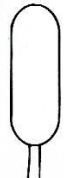

Fig. 7
F14-027

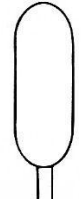

Fig. 8
F14-028



Fig. 9
F14-029



Fig. 10
F14-030



Fig. 11
F14-031



Fig. 12
F14-032



Fig. 13
F14-033

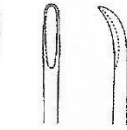

F14-034
2.8mm
Fig. 000

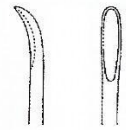

F14-035
3.4mm
Fig. 00



F14-036
4.3mm
Fig. 0



F14-037
5.5mm
Fig. 1



F14-038
6.7mm
Fig. 0



F14-039
8.0mm
Fig. 3



F14-040
11mm
Fig. 4



F14-041
15mm
Fig. 5

**Luer-Koerte
Modif With
Malleable Shaft
31 cm, 12.20"**

URETHRAL CATHETERS

Urethalkatheter | Cateteri Uretrali
Sondes Urétrales | Catéteres Uretrales



Catheter
F14-042
15 cm, 6"
No. 6-16



Catheters
F14-043 29 cm, 11 1/2"
Male Catheters charr., Metal

French

F14-044 8
F14-045 10
F14-046 12
F14-047 14
F14-048 16
F14-049 18
F14-050 20



Lister Bougies
F14-051
27 cm, 10 3/4"
00 / 1 to 15 / 18
set of 17



Clutton Bougies
F14-052 27 cm, 10 3/4"
06 / 10 FG to 28 / 32
set of 12



Van Buren
Urethral Sound
A TO O
Set of 15

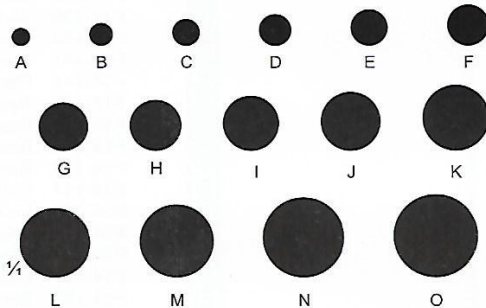

Fig.	Item	Description	Inches	Dia. Charr
A	F14-053	28 cm	11"	8 French
B	F14-054	28 cm	11"	10 French
C	F14-055	28 cm	11"	12 French
D	F14-056	28 cm	11"	14 French
E	F14-057	28 cm	11"	16 French
F	F14-058	28 cm	11"	18 French
G	F14-059	28 cm	11"	20 French
H	F14-060	28 cm	11"	22 French
I	F14-061	28 cm	11"	24 French
J	F14-062	28 cm	11"	26 French
K	F14-063	28 cm	11"	28 French
L	F14-064	28 cm	11"	30 French
M	F14-065	28 cm	11"	32 French
N	F14-066	28 cm	11"	34 French
O	F14-067	28 cm	11"	36 French



Guyon
F14-068
420 x 175 x 40 mm
Set in metal case containing:
— 21 Bougies Guyon
— 6 filiform Bougies



URETHRAL CATHETERS

Urethalkatheter
Sondes Urétrales

Cateteri Uretrali
Catéteres Uretrales



Dittel
F14-069
22.5 cm, 8 3/4"
urethral bougies and
dilating sounds

	Charr. (French)
F14-070	8
F14-071	9
F14-072	10
F14-073	11
F14-074	12
F14-075	13
F14-076	14
F14-077	15
F14-078	16
F14-079	17
F14-080	18
F14-081	19
F14-082	20
F14-083	21
F14-084	22
F14-085	23
F14-086	24
F14-087	25
F14-088	26
F14-089	27
F14-090	28
F14-091	29
F14-092	30



Dittel
14-093
35 cm, 14"
urethral bougies and
dilating sounds

	Charr. (French)
F14-094	8
F14-095	9
F14-096	10
F14-097	11
F14-098	12
F14-099	13
F14-100	14
F14-101	15
F14-102	16
F14-103	17
F14-104	18
F14-105	19
F14-106	20
F14-107	21
F14-108	22
F14-109	23
F14-110	24
F14-111	25
F14-112	26
F14-113	27
F14-114	28
F14-115	29
F14-116	30



14-217
33 cm, 13"
filiform guides,
olive tip

	Charr. (French)
F14-118	3
F14-119	4
F14-120	5
F14-121	6

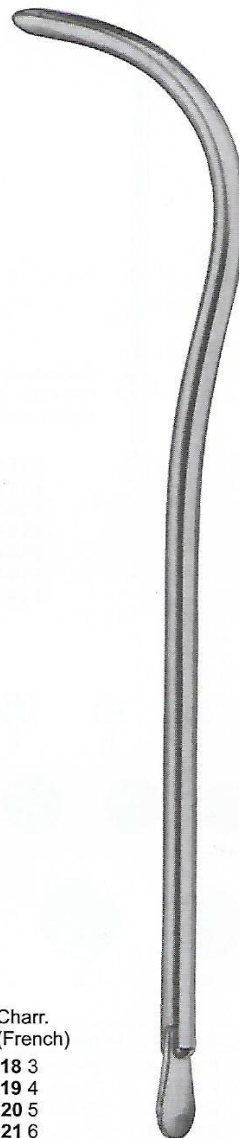

Guyon
F14-122
25 cm, 10"
urethral bougies and
dilating sounds
without filiform guides,
with thread in tip

	Charr. (French)
F14-123	Ben. 24 / Charr. 12
F14-124	Ben. 25
F14-125	Ben. 26 / Charr. 13
F14-126	Ben. 27
F14-127	Ben. 28 / Charr. 14
F14-128	Ben. 29
F14-129	Ben. 30 / Charr. 15
F14-130	Ben. 31
F14-131	Ben. 32 / Charr. 16
F14-132	Ben. 33
F14-133	Ben. 34 / Charr. 17
F14-134	Ben. 35
F14-135	Ben. 36 / Charr. 18
F14-136	Ben. 37
F14-137	Ben. 38 / Charr. 19
F14-138	Ben. 39
F14-139	Ben. 40 / Charr. 20
F14-140	Ben. 41
F14-141	Ben. 42 / Charr. 21
F14-142	Ben. 43
F14-143	Ben. 44 / Charr. 22
F14-144	Ben. 45
F14-145	Ben. 46 / Charr. 23
F14-146	Ben. 47
F14-147	Ben. 48 / Charr. 24
F14-148	Ben. 49
F14-149	Ben. 50 / Charr. 25
F14-150	Ben. 51
F14-151	Ben. 52 / Charr. 26
F14-152	Ben. 53
F14-153	Ben. 54 / Charr. 27
F14-154	Ben. 55
F14-155	Ben. 56 / Charr. 28
F14-156	Ben. 57
F14-157	Ben. 58 / Charr. 29
F14-158	Ben. 59
F14-159	Ben. 60 / Charr. 30

GALL STONE FORCEPS



Gallensteinzangen
Gallensteinlöffel

Pincettes pour calculs biliaires
Curettes pour calculs biliaires



Blake Gall Stone Forceps
F14-160 20 cm, 8"
Straight

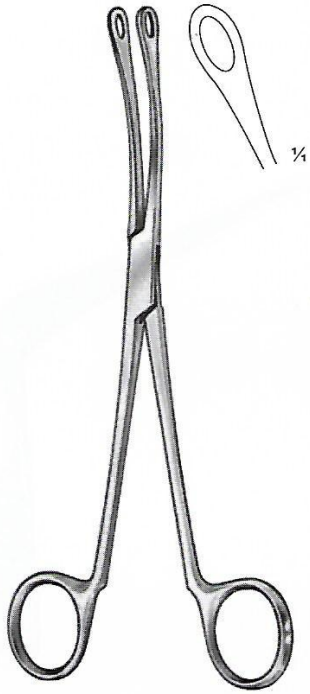

Blake Gall Stone Forceps
F14-161 20 cm, 8"
Curved

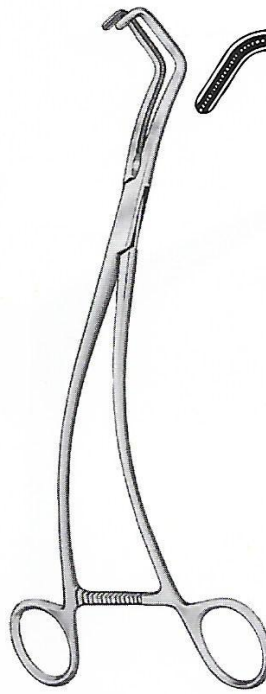

Uro-Tangential Gall Stone Forceps



F14-162
26 cm, 10 1/4"



F14-163
26 cm, 10 1/4"

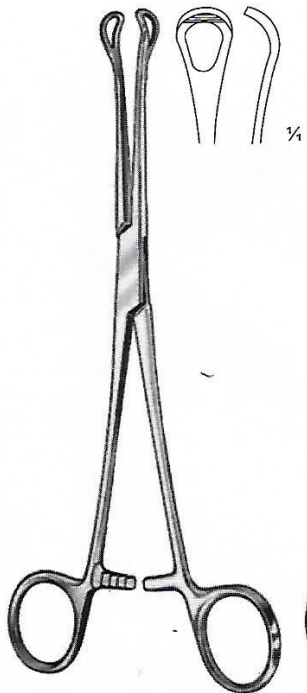

Mayo-Blake Gall Stone Forceps
F14-164 20 cm, 8"
Straight

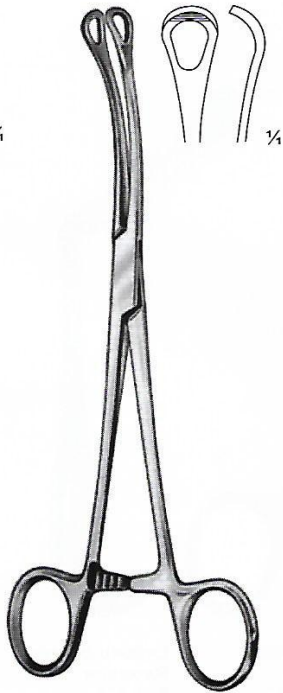

Mayo-Blake Gall Stone Forceps
F14-165 20 cm, 8"
Curved

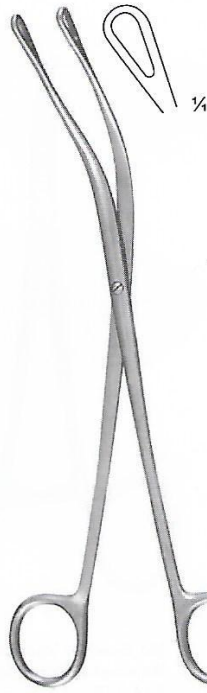

Mixer Gall Stone Forceps
F14-166 22 cm, 8 3/4"

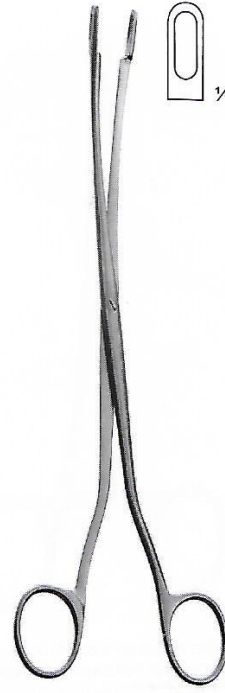

Desjardins Gall Stone Forceps
F14-167 23 cm, 9"

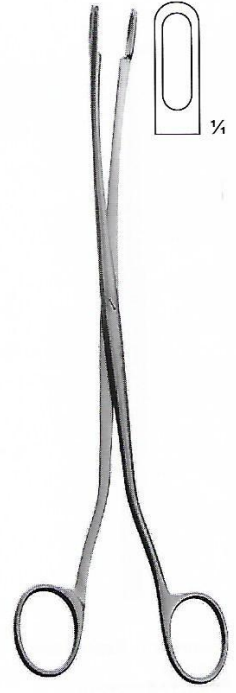

Desjardins Gall Stone Forceps
F14-168 23 cm, 9"



HERNIA DIRECTOR, VASECTOMY FORCEPS, CLAMP & BLADDER RETRACTOR

Leistenbruch Director, Vasektomie Zange, Schraubstock & Blase Retractor
Directora Hernia, Pinzas vasetomia, abrazadera y la vejiga retractor

Directeur de hernie, Pinces de vasetomie, Clamp et la vessie enrrouleur
Directore Ernia, Pinze vasetomia, Clamp & vescica Divaricatore



Child Hernia Director
F14-169



Key Hernia Director
F14-170



Teale Hernia Director
F14-171

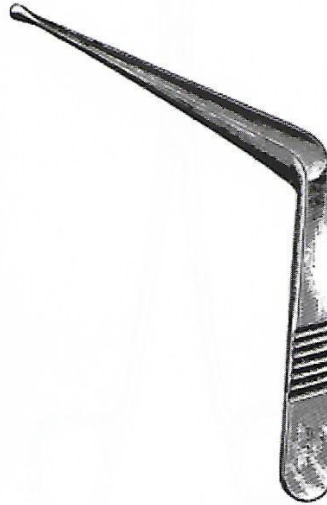

Millin Suction Tube
F14-172

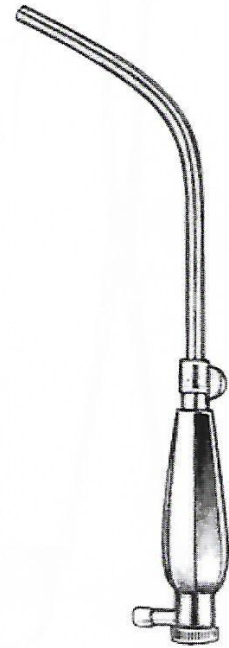

Cord Hook
F14-173
blunt 16cm



Gutmann Secretions Scoop
F14-174 26cm



No Scalpel Vasectomy Ringed Forceps Clamps
F14-175 14cm, 5.5"



No Scalpel Vasectomy Hemostat Forceps
F14-176 14cm, 5.5"
smooth sharp point curved

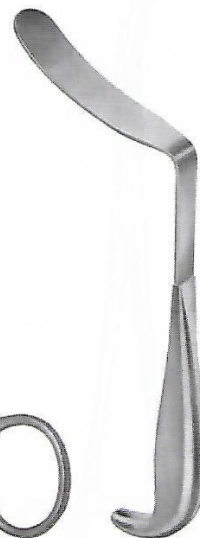

Legueu Bladder Retractor
F14-177

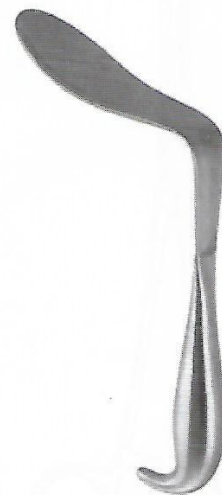

Kocher's Bladder retractor
F14-178 23.5 cm, 9.25"

BLADDER NECK SPREADER, BLADDER RETRACTORS



Blasenhalsperrer, Blasenwundsperrer

Dilatador para el cuello vesical, Separadores vesicales

Ecarteur pour le col de la vessie, Ecarteurs vésicaux

Divaricatore del collo vescicale, Divaricatore vescicale

**Knutson
F14-179**
18 cm, 7"
Urethrographie-Instruments



F14-180
Spare

Winkelmann Circumcision Clamps

- F14-181 12 mm Ø
- F14-182 16 mm Ø
- F14-183 20 mm Ø

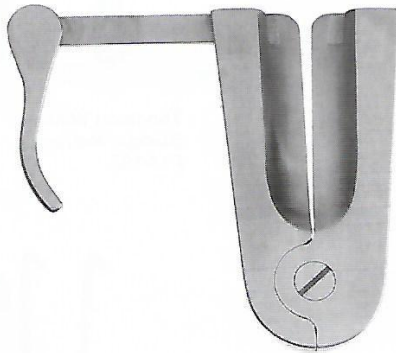
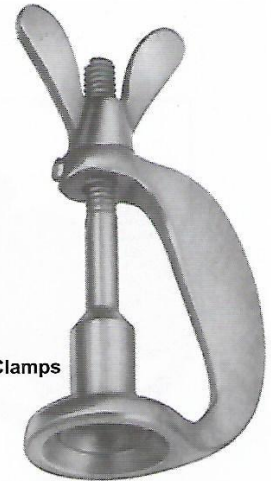

Mogen Circumcision Clamp
F14-184

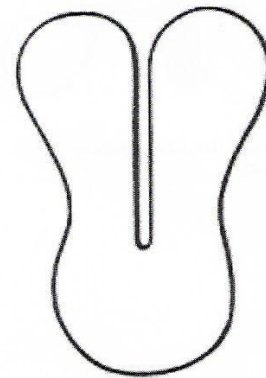

Circumcision Shield
F14-185
10cm

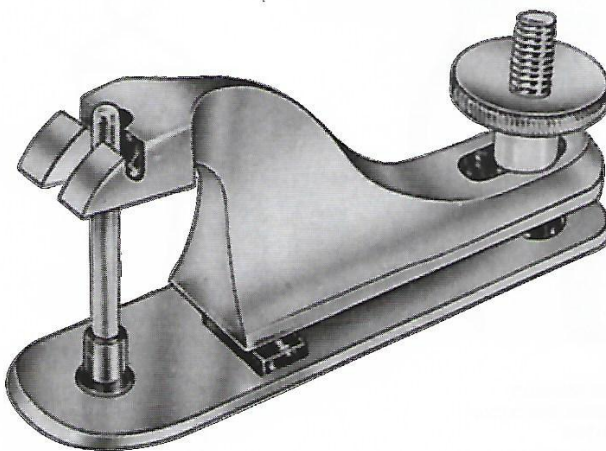

Gumco Circumcision Clamp

- | | |
|---------|------|
| | mm Ø |
| F14-186 | 8 |
| F14-187 | 11 |
| F14-188 | 13 |
| F14-189 | 16 |
| F14-190 | 21 |
| F14-191 | 26 |
| F14-192 | 32 |



Stockmann Penile Clamp
F14-193 8cm



BLADDER NECK SPREADER, BLADDER RETRACTORS

Blasenhalsperrerr, Blasenwundsperrerr

Dilatador para el cuello vesical, Separadores vesicales

Ecarteur pour le col de la vessie, Ecarteurs vésicaux

Divaricatore del collo vescicale, Divaricatore vescicale



Legueu Bladder Spatula
F14-194

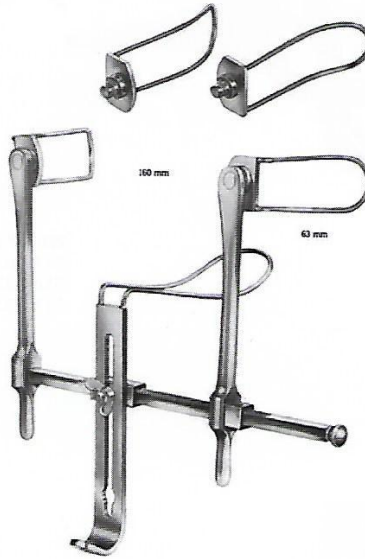

Gosset Bladder Retractor
F14-195 160mm



Thomson Walker Bladder Retractor
F14-196

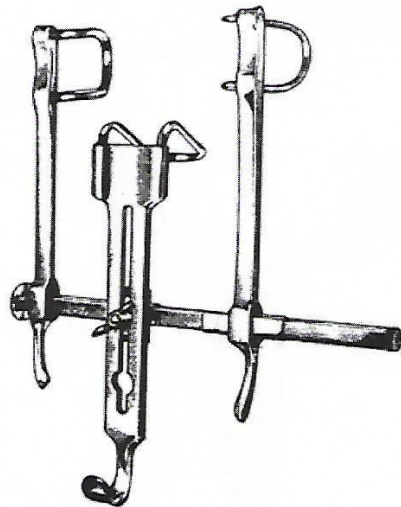

Pantings Bladder Retractor
F14-197



Judd Masson Bladder Retractor
F14-198
w/center blade



Millin Bladder Neck Spreader
F14-199
28 cm, 11"



HOLLOW WARES

- MESH BASKETS
- JARS
- KIDNEY TRAYS
- INSTRUMENTS BOXES
- STERILIZING DRUMS





STERILIZING DRUMS

Sterilisieren Schlagzeug

Tambores de esterilización

Tambours de stérilisation

Tamburi di sterilizzazione



STERILIZING DRUMS

	Ø	h
	mm	mm
F15-001	80 x 80	mm
F15-002	120 x 120	mm
F15-003	160 x 120	mm
F15-004	190 x 140	mm
F15-005	190 x 200	mm
F15-006	240 x 120	mm
F15-007	240 x 160	mm
F15-008	240 x 240	mm
F15-009	290 x 120	mm
F15-010	290 x 160	mm
F15-011	290 x 240	mm
F15-012	340 x 160	mm
F15-013	340 x 240	mm
F15-014	390 x 145	mm
F15-015	390 x 200	mm
F15-016	390 x 290	mm



STERILIZING DRUM

	Ø	h
	mm	Size mm
F15-017	150 x 150	mm
F15-018	175 x 175	mm
F15-019	190 x 190	mm
F15-020	200 x 140	mm
F15-021	200 x 200	mm
F15-022	240 x 120	mm
F15-023	225 x 225	mm
F15-024	240 x 240	mm
F15-025	290 x 160	mm
F15-026	280 x 240	mm
F15-027	230 x 150	mm
F15-028	300 x 250	mm
F15-029	340 x 250	mm
F15-030	350 x 250	mm
F15-031	390 x 200	mm



STERILIZING DRUM

	Ø	h
	mm	Size mm
F15-032	150 x 150	mm
F15-033	175 x 175	mm
F15-034	190 x 190	mm
F15-035	200 x 140	mm
F15-036	200 x 200	mm
F15-037	240 x 120	mm
F15-038	225 x 225	mm
F15-039	240 x 240	mm
F15-040	290 x 160	mm
F15-041	280 x 240	mm
F15-042	230 x 150	mm
F15-043	300 x 250	mm
F15-044	340 x 250	mm
F15-045	350 x 250	mm
F15-046	390 x 200	mm



STERILIZING DRUM

	Ø	h
	mm	Size mm
F15-047	150 x 150	mm
F15-048	175 x 175	mm
F15-049	190 x 190	mm
F15-050	200 x 140	mm
F15-051	200 x 200	mm
F15-052	240 x 120	mm
F15-053	225 x 225	mm
F15-054	240 x 240	mm
F15-055	290 x 160	mm
F15-056	280 x 240	mm
F15-057	230 x 150	mm
F15-058	300 x 250	mm
F15-059	340 x 250	mm
F15-060	350 x 250	mm
F15-061	390 x 200	mm



STERILIZING DRUM

	Ø	h
	mm	Size mm
F15-062	150 x 150	mm
F15-063	175 x 175	mm
F15-064	190 x 190	mm
F15-065	200 x 140	mm
F15-066	200 x 200	mm
F15-067	240 x 120	mm
F15-068	225 x 225	mm
F15-069	240 x 240	mm
F15-070	290 x 160	mm
F15-071	280 x 240	mm
F15-072	230 x 150	mm
F15-073	300 x 250	mm
F15-074	340 x 250	mm
F15-075	350 x 250	mm
F15-076	390 x 200	mm

HOLLOWARE INSTRUMENTS

Hohlware Instrumenten
Orfebreria Instrumentos

orfèvererie de Instruments de
Holloware Gli strumenti

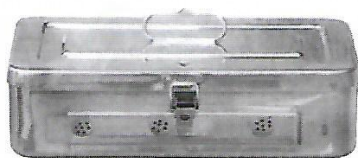

G LOVES BOX
F15-077
300 x 150 mm



INSTRUMENT TRAY WITH COVER
F15-078



INSTRUMENT TRAY
F15-079

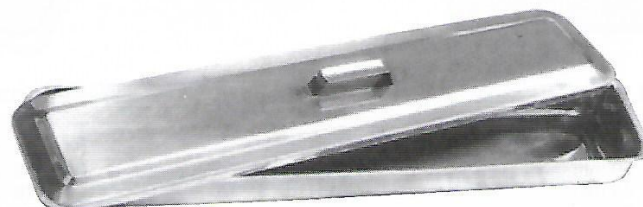

CATHER TRAY

	Size
F15-080	230 x 75 mm
F15-081	350 x 90 mm
F15-082	430 x 100 mm
F15-083	200 x 100 mm
F15-084	300 x 100 mm
F15-085	350 x 100 mm

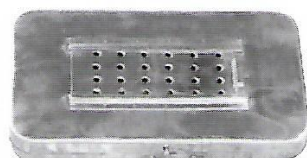

PERFORATED BOX

	Size
F15-086	100 x 50 mm
F15-087	165 x 65 mm
F15-088	250 x 100 mm
F15-089	250 x 150 mm
F15-090	250 x 200 mm
F15-091	150 x 65 mm
F15-092	170 x 70 mm
F15-093	200 x 100 mm
F15-094	250 x 125 mm
F15-095	300 x 150 mm
F15-096	300 x 200 mm
F15-097	300 x 130 mm
F15-098	320 x 150 mm
F15-099	420 x 180 mm
F15-100	460 x 125 mm
F15-101	355 x 180 mm
F15-102	300 x 180 mm
F15-103	400 x 200 mm
F15-104	510 x 200 mm

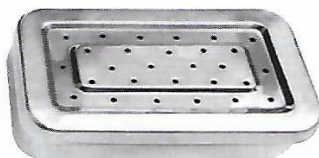

BOX WITH FILTER

	Size
F15-105	100 x 50 mm
F15-106	165 x 65 mm
F15-107	250 x 100 mm
F15-108	250 x 150 mm
F15-109	250 x 200 mm
F15-110	150 x 65 mm
F15-111	170 x 70 mm
F15-112	200 x 100 mm
F15-113	250 x 125 mm
F15-114	300 x 150 mm
F15-115	300 x 200 mm
F15-116	300 x 130 mm
F15-117	320 x 150 mm
F15-118	420 x 180 mm
F15-119	460 x 125 mm
F15-120	355 x 180 mm
F15-121	300 x 180 mm
F15-122	400 x 200 mm
F15-123	510 x 200 mm

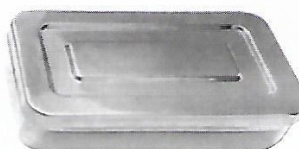

INSTRUMENTS BOX

	Without Clip	Size
F15-124	100 x 50 mm	
F15-125	165 x 65 mm	
F15-126	250 x 100 mm	
F15-127	250 x 150 mm	
F15-128	250 x 200 mm	
F15-129	150 x 65 mm	
F15-130	170 x 70 mm	
F15-131	200 x 100 mm	
F15-132	250 x 125 mm	
F15-133	300 x 150 mm	
F15-134	300 x 200 mm	
F15-135	300 x 130 mm	
F15-136	320 x 150 mm	
F15-137	420 x 180 mm	
F15-138	460 x 125 mm	
F15-139	355 x 180 mm	
F15-140	300 x 180 mm	
F15-141	400 x 200 mm	
F15-142	510 x 200 mm	



INSTRUMENT BOX

	With Clip	Size
F15-143	100 x 50 mm	
F15-144	165 x 65 mm	
F15-145	250 x 100 mm	
F15-146	250 x 150 mm	
F15-147	250 x 200 mm	
F15-148	150 x 65 mm	
F15-149	170 x 70 mm	
F15-150	200 x 100 mm	
F15-151	250 x 125 mm	
F15-152	300 x 150 mm	
F15-153	300 x 200 mm	
F15-154	300 x 130 mm	
F15-155	320 x 150 mm	
F15-156	420 x 180 mm	
F15-157	460 x 125 mm	
F15-158	355 x 180 mm	
F15-159	300 x 180 mm	
F15-160	400 x 200 mm	
F15-161	510 x 200 mm	



HOLLOWARE INSTRUMENTS

Hohlware Instrumenten
Orfebrería Instrumentos

orfèverie de Instruments de
Holloware Gli strumenti

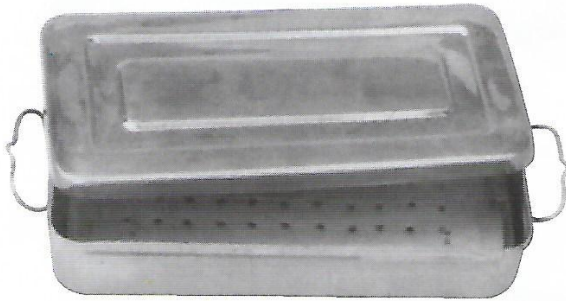

INSTRUMENT BOILER

	Size
F15-162	180 x 80 x 40 mm
F15-163	200 x 100 x 50 mm
F15-164	250 x 125 x 40 mm
F15-165	300 x 150 x 60 mm
F15-166	350 x 175 x 75 mm
F15-167	400 x 200 x 100 mm



PERFORATED TRAY

	Size
F15-168	180 x 80 x 40 mm
F15-169	200 x 100 x 50 mm
F15-170	250 x 125 x 40 mm
F15-171	300 x 150 x 60 mm
F15-172	350 x 175 x 75 mm
F15-173	400 x 200 x 100 mm



INSTRUMENT BOILER WITH STAND

	Size
F15-174	180 x 80 x 40 mm
F15-175	200 x 100 x 50 mm
F15-176	250 x 125 x 40 mm
F15-177	300 x 150 x 60 mm
F15-178	350 x 175 x 75 mm
F15-179	400 x 200 x 100 mm



INSTRUMENT BOILER ELECTRIC

	Size
F15-180	180 x 80 x 40 mm
F15-181	200 x 100 x 50 mm
F15-182	250 x 125 x 40 mm
F15-183	300 x 150 x 60 mm
F15-184	350 x 175 x 75 mm
F15-185	400 x 200 x 100 mm

HOLLOWARE INSTRUMENTS



Hohlware Instrumenten
Orfebreria Instrumentos

orfèvrerie de Instruments de
Holloware Gli strumenti



NEEDLE CASE
F15-186
230 x 125 mm

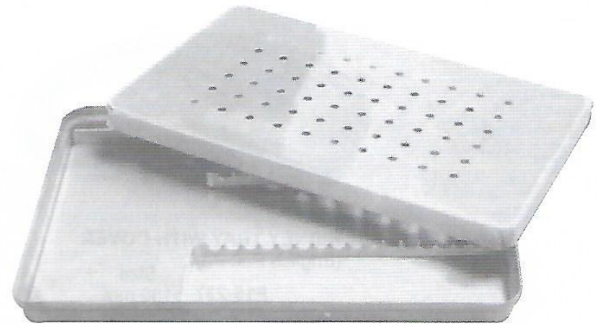

SCALER BOX
F15-187
300 x 180 mm

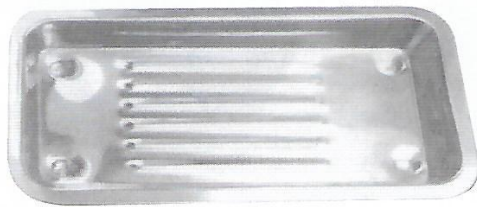

SCALER TRAY
F15-188
100 x 200 mm



INDO BOX WITH SILVER FRAME
F15-189



Autoclaveable
F15-190

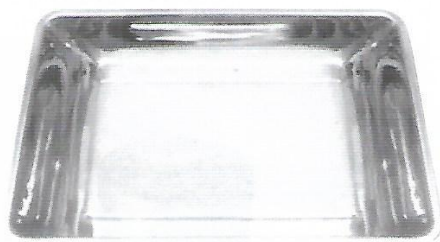

INSTRUMENT TRAY WITHOUT COVER

	Size		Size
F15-191	240 x 240 mm	F15-202	230 x 125 mm
F15-192	355 x 400 mm	F15-203	200 x 150 mm
F15-193	300 x 150 mm	F15-204	250 x 200 mm
F15-194	300 x 180 mm	F15-205	300 x 250 mm
F15-195	300 x 240 mm	F15-206	350 x 300 mm
F15-196	340 x 320 mm	F15-207	400 x 350 mm
F15-197	230 x 180 mm	F15-208	450 x 300 mm
F15-198	250 x 130 mm	F15-209	300 x 200 mm
F15-199	200 x 130 mm	F15-210	350 x 250 mm
F15-200	180 x 130 mm	F15-211	250 x 125 mm
F15-201	150 x 100 mm	F15-212	200 x 100 mm
		F15-213	400 x 200 mm



INSTRUMENT TRAY WITHOUT COVER

	Size		Size
F15-214	240 x 240 mm	F15-225	230 x 125 mm
F15-215	355 x 400 mm	F15-226	200 x 150 mm
F15-216	300 x 150 mm	F15-227	250 x 200 mm
F15-217	300 x 180 mm	F15-228	300 x 250 mm
F15-218	300 x 240 mm	F15-229	350 x 300 mm
F15-219	340 x 320 mm	F15-230	400 x 350 mm
F15-220	230 x 180 mm	F15-231	450 x 300 mm
F15-221	250 x 130 mm	F15-232	300 x 200 mm
F15-222	200 x 130 mm	F15-233	350 x 250 mm
F15-223	180 x 130 mm	F15-234	250 x 125 mm
F15-224	150 x 100 mm	F15-235	200 x 100 mm
		F15-236	400 x 200 mm



HOLLOWARE INSTRUMENTS

Hohlware Instrumenten
Orfebreria Instrumentos

orfèvrerie de Instruments de
Holloware Gli strumenti



KIDNEY TRAY WITH COVER
(English Pattern)

	Size
F15-237	150 mm
F15-238	200 mm
F15-239	240 mm
F15-240	300 mm



KIDNEY TRAY (German Pattern)
(without cover)

	Size
F15-241	150 mm
F15-242	200 mm
F15-243	240 mm
F15-236	300 mm



SPLIT LAMP
F15-245
100 ml.



BOWL

	Size
F15-246	80 mm
F15-247	100 mm
F15-248	125 mm
F15-249	150 mm
F15-250	200 mm
F15-251	250 mm
F15-252	300 mm
F15-253	350 mm
F15-254	400 mm



WASH BASIN

	Size
F15-255	80 mm
F15-256	100 mm
F15-257	125 mm
F15-258	150 mm
F15-259	200 mm
F15-260	250 mm
F15-261	300 mm
F15-262	350 mm
F15-263	400 mm



BOWL

	Size
F15-264	80 mm
F15-265	100 mm
F15-266	125 mm
F15-267	150 mm
F15-268	200 mm
F15-269	250 mm
F15-270	300 mm
F15-271	350 mm
F15-272	400 mm



DRESSING JAR WITH KNOB

	Size
F15-273	80 x 80 mm
F15-274	100 x 100 mm
F15-275	125 x 125 mm
F15-276	150 x 150 mm
F15-277	200 x 200 mm



DRESSING JAR

	Size
F15-278	80 x 80 mm
F15-279	100 x 100 mm
F15-280	125 x 125 mm
F15-281	150 x 150 mm
F15-282	200 x 200 mm



DRESSING JAR

	Size
F15-283	80 x 80 mm
F15-284	100 x 100 mm
F15-285	125 x 125 mm
F15-286	150 x 150 mm
F15-287	200 x 200 mm



DRESSING JAR

	Size
F15-288	80 x 80 mm
F15-289	100 x 100 mm
F15-290	125 x 125 mm
F15-291	150 x 150 mm
F15-292	200 x 200 mm

HOLLOWARE INSTRUMENTS

Hohlware Instrumenten
Orfebreria Instrumentos

orfèvererie de Instruments de
Holloware Gli strumenti



**FORCEPS
JAR**

	Size
F15-293	55 x 100 mm
F15-294	55 x 140 mm
F15-295	55 x 170 mm
F15-296	55 x 180 mm
F15-297	80 x 100 mm



**FORCEPS
JAR**

	Size
F15-298	55 x 100 mm
F15-299	55 x 140 mm
F15-300	55 x 170 mm
F15-301	55 x 180 mm
F15-302	80 x 100 mm



**FORCEPS
JAR**

	Size
F15-303	55 x 100 mm
F15-304	55 x 140 mm
F15-305	55 x 170 mm
F15-306	55 x 180 mm
F15-307	80 x 100 mm



**FORCEPS
JAR**

	Size
F15-308	55 x 100 mm
F15-309	55 x 140 mm
F15-310	55 x 170 mm
F15-311	55 x 180 mm
F15-312	80 x 100 mm



**FORCEPS
JAR**

	Size
F15-313	55 x 100 mm
F15-314	55 x 140 mm
F15-315	55 x 170 mm
F15-316	55 x 180 mm
F15-317	80 x 100 mm



**COTTON HOLDER
F15-318**



GALIPOTS

	Capacity
F15-319	2 Ounces
F15-320	3 Ounces
F15-321	4 Ounces
F15-322	5 Ounces
F15-323	6 Ounces
F15-324	7 Ounces
F15-325	8 Ounces



GALIPOTS

	Capacity
F15-326	2 Ounces
F15-327	3 Ounces
F15-328	4 Ounces
F15-329	5 Ounces
F15-330	6 Ounces
F15-331	7 Ounces
F15-332	8 Ounces



**SPRIT LAMP
F15-333
100 ml.**



**INDO BOX ROUND
F15-334**

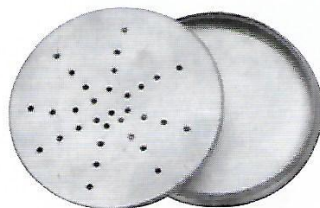

**NEEDLE CASE
F15-335**



MEASURING JUG

	Capacity
F15-336	1.00 Ltr
F15-337	1.50 Ltr
F15-338	2.00 Ltr



MEDICINE CUP GRADUATED

	Capacity
F15-339	50 ml
F15-340	60 ml
F15-341	100 ml



BUCKET WITH LID

	Capacity
F15-342	10 Ltr
F15-343	12 Ltr
F15-344	15 Ltr



HOLLOWARE INSTRUMENTS

Hohware Instrumenten
Orfebreria Instrumentos

orfèverie de Instruments de
Holloware Gli strumenti



SPUTUM MUG
F15-345
100 x 50 mm



ENEMA CANE
Capacity
F15-346 0.5 Ltr
F15-347 1.5 Ltr
F15-348 2.0 Ltr



DUST BIN
F15-349
20 Lit



ROUND BEDPAN
F15-350
300 x 85 mm



BEDPAN
F15-351
Size: Adult, Child



BEDPAN
F15-352
Size: Adult, Child



FUNNAL
F15-353
100 mm



URINAL - FEMALE
F15-354



URINAL - MALE
F15-355



SHAVING MUG
F15-356
100 mm

PERFORATED BASKETS

perforiert Körbe
Cestas perforadas

paniers perforés
ceste forate

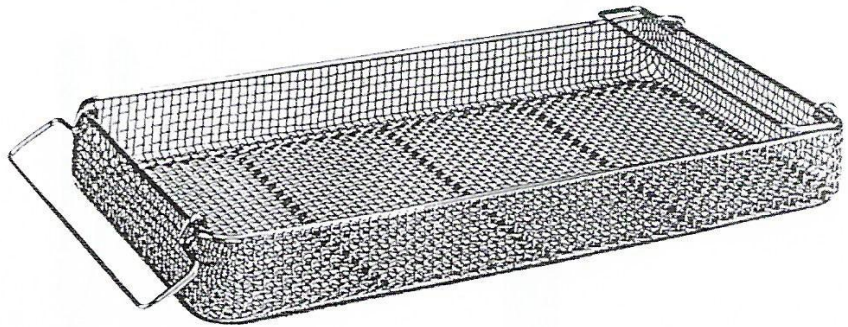
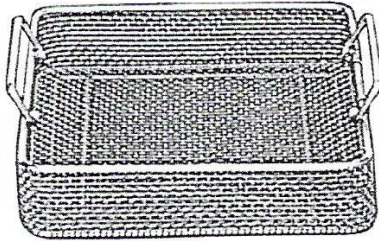

MESH BASKET

F15-357 240 x 258 x 50 mm
F15-358 250 x 240 x 100 mm
F15-359 240 x 250 x 60mm

MESH BASKET

F15-360 480 x 258 x 50 mm
F15-361 480 x 258 x 100 mm
F15-362 520 x 258 x 60mm
F15-363 520 x 258 x 70mm
F15-364 450 x 340 x 70mm
F15-365 320 x 230 x 70mm

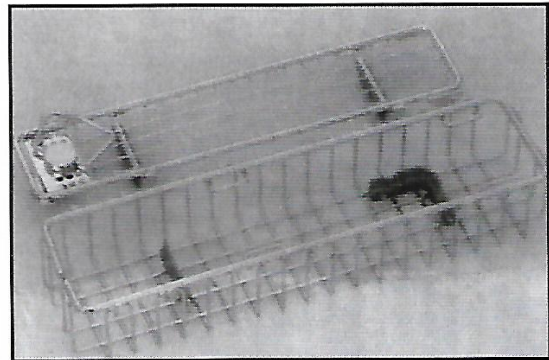

MESH BASKET

With Perforated Sheet Side

F15-366 230 x 130 x 50 mm
F15-367 230 x 130 x 60 mm
F15-368 240 x 130 x 50 mm
F15-369 240 x 130 x 60 mm
F15-370 240 x 250 x 50 mm
F15-371 240 x 250 x 60 mm
F15-372 480 x 250 x 50 mm
F15-373 480 x 250 x 60 mm
F15-374 480 x 250 x 70 mm
F15-375 300 x 300 x 50 mm
F15-376 350 x 350 x 60 mm
F15-377 470 x 400 x 60 mm
F15-378 480 x 480 x 50 mm
F15-379 480 x 480 x 60 mm
F15-380 500 x 300 x 50 mm
F15-381 520 x 300 x 50 mm
F15-382 520 x 300 x 60 mm
F15-383 550 x 430 x 50 mm
F15-384 600 x 300 x 60 mm

ARTHROSCOPE BASKET

F15-385 290 x 80 x 52 mm

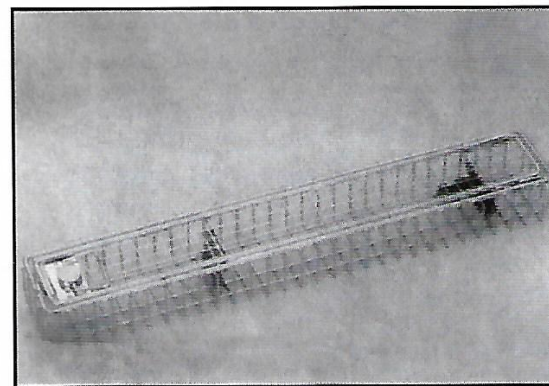

ENDOSCOPE BASKET

F15-386 460 x 80 x 52 mm
F15-387 660 x 80 x 52 mm
F15-388 670 x 80 x 52 mm



STERILIZING FORCEPS

Sterilisieren Zange

Pinces stérilisation

Pinzas de esterilización

Pinze di sterilizzazione



DAVIS

F15-389 16 cm, 6 1/4"

F15-390 20 cm, 8"

F15-391 24 cm, 9 1/2"

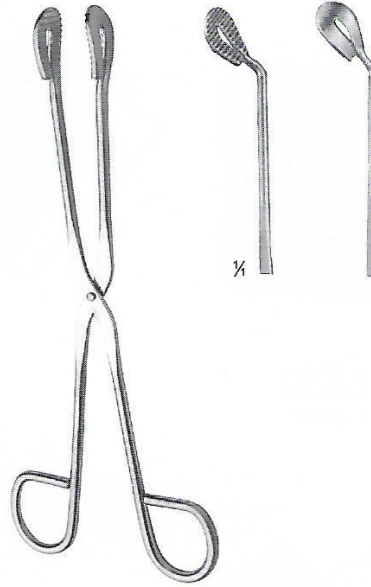

UTILITY

F15-392 20 cm, 8"

F15-393 28 cm, 11"



F15-394 20 cm, 8"
F15-395 25 cm, 10"
F15-396 30 cm, 11 3/4"



ROGGE

F15-397
27 cm, 11"



CHEATEL

Box Joint
F15-398
27 cm, 11"

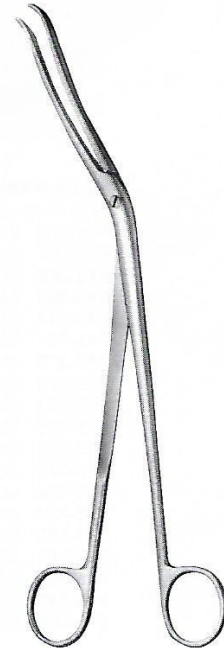

CHEATEL

Screw Joint
F15-399
27 cm, 11"



INDEX



INDEX

Index
indice

Index
indice

DESCRIPTION PAGE

A

ABDOMINAL RETRACTOR209, 359

ABRAHAM TONSIL KNIFE305

ABREBOCAMC IVOR C/3 LAMINAS S/ SUCCAO206

ADLERKREUTZ TISSUE FORCEPS70

ADSON DRESSING FORCEPS TC84

ADSON TISSUE FORCEPS TC84

ADSON BROWN TISSUE FORCEPS76

ADSON DRILL GUIDE324

ADSON HAEMOSTATIC FINE POINT FORCEPS94

ADSON HAEMOSTATIC TISSUE FORCEPS94

ADSON NEEDLE HOLDERS128

ADSON RETRACTOR201

ADSON SUCTION TUBES17

ADSON TISSUE FORCEPS76, 85

ADSON-BROWN TISSUE FORCEPS85

AESCULAP SPONGE & DRESSING FORCEPS120

ALEXANDER CHISEL217

ALEXANDER GOUGE217

ALLIS TISSUE FORCEPS340

ALIM RETRACTOR196

AMPUTATION KNIFE28

ANAESTHOPHON STETHOSCOPE01

ANDERSON-ADSON RETRACTOR201

ANDERSON-NIEVERT OSTEOTOME221

ARRUGANEEDELE HOLDERS133-134

ARRUGANEEDELE HOLDERS TC146

ARTERY SCISSORS47

ARTHROSCOPE BASKET398

ASH SEPTUM FORCEPS311

AUFRICHT NASAL SAW310

AUVARD, SPECULUM & RETRACTOR356

AYRE CONE KNIFE FISTULAHOOK371

B

BABCOCK INTESTINAL & TISSUE GRASPING CLAMP FORCEPS T.C343

BABCOCK SEIZING FORCEPS341-342

BABCOCK TISSUE GRASPING FORCEPS342

BABINSKY HAMMER03

BABYALLIS TISSUE FORCEPS340

BABY CRILE-WOOD NEEDLE HOLDER126

BABY CRILE-WOOD NEEDLE HOLDERS T.C140

BABY METZENBAUM SUPER CUT SCISSORS61

BABY-DOYEN INTESTINAL FORCEPS CLAMPS344

BABY-KOCHER INTESTINAL FORCEPS CLAMPS344

BABY-MIKULICZ HAEMOSTATIC TISSUE FORCEPS107

BABY-ROUX RETRACTOR178

BACKHAUS CLIP TOWEL FORCEPS113

BACKHAUS TOWEL FORCEPS113

BAKES COMMON BILE384

BALFOUR RETRACTOR205

BALFOUR-BABY RETRACTOR204

BALL & SOCKET TOWEL FORCEPS113

BALLENGER KNIFE314

BALLENGER-HAJEK PERIOSTEAL SEPTUM ELEVATORS307

BANDAGE SCISSORS56

BANE BONE RONGEUR248

BARANY NOISE DRUM291

BARNHILLADENOID CURETTE313

BARR CRYPT HOOK21

BARR FISTULA PROBE21

BARR RECTAL SPECULUM348

BARRAQUER CILIA FORCEPS80

BARRAQUER NEEDLE HOLDERS132-133

BARRAQUER SCISSORS49

BARRAQUER-TROUTMAN NEEDLE HOLDERS134

BARRETT TENACULUM FORCEPS365

BARR-SHILFORD INTESTINAL RECTAL SPECULUM350

BAUMGARTNER NEEDLE HOLDER125

BAUMGARTNER NEEDLE HOLDERS T.C136

BAUMGARTNER NEEDLE HOLDERS T.C141

BAYONET MICRO KERRISON LAMINECTOMY RONGEURS337

BAYONET SPURLING KERRISON LAMINECTOMY RONGEURS337

BEACHAM AMNIOTOME366

BECKMAN ADENOID CURETTE313

BECKMAN RETRACTOR202

BECKMANN ADENOID CURETTE313

BECKMANN NASAL SPECULUM301

BECKMAN-WEITLANER RETRACTOR202

BEDPAN397

BEER CILIA FORCEPS80

BEEBEE WIRE CUTTING SCISSORS45

BENDING DEVICE ANGLED PLATES286

BENNETT RETRACTOR187

BENGOLEA HAEMOSTATIC FORCEPS100

BENGOLEA HAEMOSTATIC TISSUE FORCEPS100

BENSAUDE INTESTINAL RECTAL SPECULUM349

BERGER BIOPSY FORCEPS369

DESCRIPTION PAGE

BERGMANN MALLETS215

BERGMANN SCISSORS55

BERLINER HAMMER03

BERNHARD TOWEL FORCEPS114

BERTILLON MEASURING DEVICE13

BEYER BONE EAR RONGEURS298

BEYER BONE RONGEUR249

BILLEAU EAR LOOP294

BIOLVAR21

BIRCHER MENISCOTOMY KNIFE239

BIRCHER-GANSKE BONE HOLDING FORCEPS272

BISHOP BONE CLAMP268

BISHOP FORCEPS70

BLAKE DOUBLE ENDED372

BLAKE GALL STONE FORCEPS387

BLOHMKE TONSIL FORCEPS316

BLOOD SCOOP195

BLOUNT KNEE RETRACTOR177

BLOUNT RETRACTOR237

BLUMENTHAL BONE RONGEUR246

BOHLER BONE CUTTING RONGEUR FORCEPS257

BOHLER BONE RONGEUR249

BOHLER KIRSCHNER EXTENSION BOWS288

BOIES NASAL FRACTURE ELEVATOR307

BONE CURETTE227

BONE CUTTING RONGEUR FORCEPS257

BONE HOLDING FORCEPS275

BONE LEVER236

BONE REDUCTION FORCEPS265, 271, 275-276

BONE REDUCTION ORTHOPEDIC FORCEPS265

BONE TAMPS226

BONNEY DISSECTING & TISSUE FORCEPS T.C87

BONNEY TISSUE FORCEPS73

BOUCHERON EAR SPECULUM290

BOWL395

BOWMAN LACRIMAL PROBES155

BOYNTON NEEDLE HOLDERS133

BOYS-ALLIS TISSUE FORCEPS341

BOZEMANN HAEMOSTATIC FORCEPS106

BOZEMANN NEEDLE HOLDERS127

BOZEMANN NEEDLE HOLDERS T.C137

BRAIN SPATULA325

BRAND TENDON FORCEPS241

BRAUN OBSTETRICAL FORCEPS378

BRAUN UTERINE DEPRESSOR372

BRAUN, MIDWIFERY DECAPITATING HOOK379

BRAUN-STADLER PLASTER SCISSORS56

BREISKY PELVIMETER, OBSTETRICAL FORCEPS376

BREISKY SPECULUM357

BRINKERHOFF INTESTINAL RECTAL SPECULUM350

BRISTOW BONE LEVER236

BRISTOW-BANKART HUMERAL RETRACTOR235

BRISTOW-BANKART SOFT TISSUE RETRACTOR235

BRODIE PROBE156

BROM HOOKLET RETRACTORS162

BROPHY DRESSING FORCEPS69

BROWN NEEDLE HOLDER126, 128

BRUENINGS NASAL CUTTING FORCEPS304

BRUENINGS TONSIL KNIFE305

BRUENINGS TONSIL SNARE318

BRUENINGS-BRUNKANTRUM RETRACTOR311

BRUNER RETRACTOR182-183

BRUNS BONE CURETTE227

BRUENING SPATULA195

BUCK EAR POLYPUS FORCEPS296

BUCK HAMMER02

BUCK STITCH SCISSORS42

BUCK EAR CURETTE293

BUCKET WITH LID396

BUCKLEY RETRACTOR196

BUIE HIRSCHMAN ANOSCOPE INTESTINAL RECTAL SPECULUM351

BUIE SUCTION TUBE21

BULLDOG CURVED70

BULLDOG STRAIGHT70

BURNHAM BANDAGE PLASTER SCISSORS55

BUSCH PLASTER SCISSORS56

BUTTERFLY GROOVED DIRECTOR WITH TONGUE TIE PLAIN END20

C

CAIRNS HAEMOSTATIC FORCEPS94

CANNULATED WIRE / PIN CUTTER262

CAPENER CHISELS220

CAPENER OSTEOTOME220

CAPLAN SEPTUM FORCEPS312

CAPSULE RETRACTOR235

CARLENS MEDIASTINOSCOPE, EXTRA-LONG321

CARLENS MEDIASTINOSCOPE, LONG321

CARLENS MEDIASTINOSCOPE, SHORT321

CARMALT FORCEPS81

INDEX



Index | Index
indice | indice

DESCRIPTION	PAGE #	DESCRIPTION	PAGE #
CAROLL POCKET GONIOMETER	13	COTTLE SCISSORS	43
CARROLL NEEDLE HOLDERS T.C.	135	COTTLE SEPTUM ELEVATORS RASPARTORY	306
CARROLL TENDON FORCEPS	241	COTTLE-KAZANJIAN BONE CUTTING RONGEUR FORCEPS	255
CASPAR BONE TAMPS	226	COTTLE-WALSHAM SEPTUM FORCEPS	311
CASPAR RETRACTOR	175	COTTON HOLDER	396
CASPAR TYPE INTERVERTEBRAL DISC RONGEURS	331	COUNTERSINK REAMERS	283
CAST SPREADER MODEL USA	245	CRAFOORD HAEMOSTATIC FORCEPS	101
CASTROVIEJO BONE CALIPER	14	CRAFOORD-SELLORS HAEMOSTATIC FORCEPS	102
CASTROVIEJO CORNEAL MICRO SCISSORS	49	CRAIG NASAL POLYPUS AND SEPTUM FORCEPS	303
CASTROVIEJO EYE SPECULUM	196	CREGO PERIOSTEAL ELEVATOR	233
CASTROVIEJO EYE VIEW CALIPER	14	CRILE HAEMOSTATIC FINE POINT TISSUE FORCEPS	91
CASTROVIEJO NEEDLE HOLDERS	132-134	CRILE HAEMOSTATIC FINE POINT FORCEPS	91
CASTROVIEJO NEEDLE HOLDERS T.C	141, 146-147	CRILE HAEMOSTATIC FORCEPS	91
CASTROVIEJO OLSEN HEAGER / NEEDLE HOLDERS / SCISSORS	133	CRILE HAEMOSTATIC TISSUE FORCEPS	91
CASTROVIEJO SCISSORS	48	CRILE HOOKLET & SKIN HOOKS	160
CASTROVIEJO SCISSORS T/C INSERT	66	CRILE RETRACTOR	177
CASTROVIEJO-EPKER CALIPER	14	CRILE-MURRAY NEEDLE HOLDERS	130
CATHER TRAY	392	CRILE-WOOD NEEDLE HOLDER	126
CATHETERS	385	CRILE-WOOD NEEDLE HOLDERS T.C	143-135, 145
CATLIN AMPUTATION	28	CRUTCHFIELD DRILL BIT	324
CATLIN DISSECTING KNIVES	27	CRUTCHFIELD SKULL LARGE TYPE, CERVICAL TRACTION	324
CHAPUT HAEMOSTATIC FORCEPS	116	CRUTCHFIELD TRACTION TONGS	324
CHAPUT TISSUE FORCEPS	341	CURETTE	229
CHARNLEY TISSUE FORCEPS	72	CUSCO VAGINAL SPECULUM	352
CHARNLEY-MUELLER COMPRESSION CLAMP	288	CUSHING DECOMPRESSION RETRACTOR	238
CHARRIERE AMPUTATION & RESECTION	28	CUSHING HOOKLET RETRACTORS	168
CHARRIERE BONE SAW COMPLETE	211	CUSHING HOOKLET RETRACTORS	168
CHARRIERE PLASTER SAW	59	CUSHING INTERVERTEBRAL DISC RONGEURS	330-331, 333
CHARRIERE SAW	211	CUSHING NERVE DURAHOOK	327
CHEATEL STERILIZING FORCEPS	399	CUSHING NERVE DURAHOOK RETRACTOR	328
CHEEK-AND LIP RETRACTOR	187	CUSHING TISSUE FORCEPS T.C	86
CHELSEA-EATON INTESTINAL RECTAL SPECULUM	350	CUSHING VEIN RETRACTOR	238
CHERON FORCEPS	121	CUSHING, BRAIN SPATULA	325
CHEVALIER-JACKSON TRACHEATUBES	320	CUSHING-KOCHER HOOKLET RETRACTORS	168
CHICHIRELLI (BLUMENTHAL) RONGEUR	247	CUZZI OVUM CURETTE	380
CHILD HERNIA DIRECTOR	388	CZERNY RECTAL SPECULUM	348
CHILDE TISSUE FORCEPS	83	CZERNY TENACULUM FORCEPS	366
CHRISTOPHE HAEMOSTATIC FORCEPS	93		
CINELLI CHISEL	224	D	
CIRCUMCISION SHIELD	389	DANDY HAEMOSTATIC FORCEPS	90
CITELLI BONE EAR RONGEURS	298	DANDY HAEMOSTATIC TISSUE FORCEPS	90
CLEVELAND BONE CUTTING RONGEUR FORCEPS	255	DARLING RETRACTOR	197
CLEVELAND BONE RONGEUR	248	DARTIGUES UTERINE ELEVATING FORCEPS	382
CLEVELAND-GARDNER BONE CUTTING RONGEUR FORCEPS	257	DAVIDSON RETRACTOR	181
CLIPS MAYO	157	DAVIS DURA DISSECTOR	329
CLOWARD INTERVERTEBRAL DISC RONGEURS	332	DAVIS STERILIZING FORCEPS	399
CLOWARD RETRACTOR	339	DAY HOOKLET & SKIN HOOKS	160
CLOWARD VERTIBRAL CERVICAL SPREADER	339	DE BAKY DRESSING FORCEPS T.C	88
CLUTTON BOUGIES	385	DE BAKY FEMUR RETRACTOR	203
COAKLEY, TROCAR	16	DE BAKY NEEDLE HOLDERS T.C	145
COHEN NIPPERS	46	DE BAKY VASCULAR SCISSORS	39-40
COLLER HAEMOSTATIC FORCEPS	93	DE LEE OBSTETRICAL FORCEPS	377
COLLIER NEEDLE HOLDERS	130	DE LEE PELVIMETER, OBSTETRICAL FORCEPS	376
COLLIN DISSECTING KNIVES	27	DE MARTEL SAW CONDUCTOR	324
COLLIN FORCEPS	83	DE VILBISS SKULL FORCEPS	324
COLLIN KIDNEY ELEVATING STONE CLAMPS FORCEPS	382	DEAN (BLUMENTHAL) RONGEUR	247
COLLIN MALLETS	214	DEAN RONGEUR	247
COLLIN OBSTETRICAL FORCEPS	379	DEAN-DELICATE DISSECTING SCISSORS	40
COLLIN PELVIMETER, OBSTETRICAL FORCEPS	376	DEAVER OPERATING, DISSECTING SCISSORS	31
COLLIN RETRACTOR	179, 206, 208	DEAVER RETRACTOR	184-185
COLLIN SPONGE & DRESSING FORCEPS	119, 123	DEBAKEY GELPI RETRACTOR	198
COLLIN VAGINAL SPECULUM	352	DEBAKEY MICRO NEEDLE TISSUE FORCEPS T.C	87
COLLIN-DUVAL FORCEPS	74	DEBAKEY NEEDLE HOLDERS	151
COLLING DRESSING HAEMOSTATIC FORCEPS	117	DEBAKEY-NEEDLE RETRACTOR	189
COLLIN-HARTMANN RETRACTOR	166	DECKER INTERVERTEBRAL DISC RONGEURS	333
COLLIN VAGINAL SPECULUM	353	DEJERINE HAMMER	02
COLVER TONSIL FORCEPS	316	DELICATE WIRE CUTTER	261
COMBINATION Mallet	215	DENHART MOUTH GAG	315
CONE RETRACTOR BECKMAN RETRACTOR	202	DERF NEEDLE HOLDER	130, 150
CONVERSE HOOK	160	DERF NEEDLE HOLDERS T.C	141
COOLEY INTRACARDIAC NEEDLE HOLDERS T.C	140	D'ERRICO-ADSON RETRACTOR	201
COOLEY MICROVASCULAR NEEDLE HOLDER T.C	144	DESCHAMPS NEEDLE	153-154
COOLEY REVERSE CUT SCISSORS	38	DESJARDINS GALL STONE FORCEPS	387
COOLEY VASCULAR SCISSORS	39	DESJARDINS HAEMOSTATIC FORCEPS	104
COOLEY-BAUMGARTEN WIRE TWISTER NEEDLE HOLDERS T.C	142	DESJARDINS PROBE	384
CORD HOOK	388	DESJARDIM	21
CORWIN NEEDLE HOLDERS T.C	148	DESMARRES LID RETRACTORS	168
CORWIN ROUND SCALPEL HANDLE	24	DIAGNOSTIC PENTOSCOPE SET	09
CORWIN ROUND SCALPEL HANDLE, #4R	24	DICK HAEMOSTATIC FORCEPS	111
CORYLLOS RETRACTOR	181	DIEFFENBACH DISSECTING KNIVES	27
COTTLE CARTILAGE CRUSHER	311	DIEFFENBACH SCALPEL HANDLES	26
COTTLE CHISEL	224	DINGMAN BONE CLAMP	266
COTTLE GUIDE SUPPORT FOR OSTEOATOMES	311	DIRECTOR PROBE END	156
COTTLE HANDLE	311	DIRECTORS LARRY PROBE	156
COTTLE MALLETS	214	DISSECTING DRESSING FORCEPS	72
COTTLE NASAL SAW	310	DISSECTING KITS	11-12
COTTLE NASAL SPECULUM	302	DISSECTING SETS	10
COTTLE OSTEOOTOME	221, 223-224	DISSECTING TISSUE FORCEPS T.C	86
COTTLE PERIOSTEAL SEPTUM ELEVATORS	307	DITTEL URETHRAL BOUGIES AND DILATING SOUNDS	386
COTTLE RETRACTOR	167		



INDEX

Index | Index
indice | indice

DESCRIPTION	PAGE #	DESCRIPTION	PAGE #
DIXON-LOVELACE HAEMOSTATIC TISSUE FORCEPS	103	FINGER RAKE, RETRACTOR	163
DOUBLE ACTION WIRE CUTTER	261	FINOCCHIETTO NEEDLE HOLDERS	127
DOUBLE PRONG MICRO HOOK & SKIN HOOK	159	FINOCCHIETTO NEEDLE HOLDERS T.C	138-139
DOUGLAS CILIA FORCEPS	80	FINOCCHIETTO RETRACTOR	208
DOWNING CARTILAGE KNIFE	239	FINSEN RETRACTOR	196
DOYEN INTESTINAL FORCEPS CLAMPS	344	FISCH HOOKLET & SKIN HOOK	159
DOYEN MALLETS	214	FISCHER TONSIL KNIFE AND DISSECTOR	305
DOYEN MYOMA SCREWDRAND FISTULA HOOK	371	FLAT NOSE K-WIRE PLIERS	243
DOYEN NEEDLE HOLDERS	130	FLAT NOSE PLIER	242, 244, 245
DOYEN OPERATING, DISSECTING SCISSORS	36	FLETCHER SPONGE FORCEPS	120
DOYEN PROBE	156	FLEXIVAL ABDOMINAL SPATULA	195
DOYEN PROBES & DIRECTORS	20	FLUSH WIRE CUTTER	261
DOYEN RETRACTOR	187, 208	FOERSTER-BALLENGER SPONGE FORCEPS	123
DOYEN RIB RASPARTORY	232	FOMAN OPERATING SCISSORS T/C INSERT	66
DOYEN SPECULUM AND RETRACTOR	357	FOMAN RASP	213
DOYEN TOWEL FORCEPS	112	FOMON CHISEL	224
DOYEN VAGINAL RETRACTORS	191	FOMON NASAL SAW	310
DRESSING FORCEPS, TISSUE FORCEPS	67	FOMON RASP WITH TUNGSTEN CARBIDE TC	309
DRESSING JAR	395	FOMON SCISSORS	43
DRESSING JAR WITH KNOB	395	FORAMENOTOMY KERRISON LAMINECTOMY RONGEURS	337
DRILL GUIDE	284-285	FORCEPS JAR	396
DRILL POINTED GUIDE	285	FRAZIER HOOKLET & SKIN HOOK	159
DRILL SLEEVE	284	FRAZIER NERVE DURA HOOK RETRACTOR	328
DRILL SMALL POINTED	285	FRAZIER SUCTION TUBE	17, 323
DUCKBILL EAR FORCEPS	297	FREER CHISEL	223
DUCT DILATORS	384	FREER ELEVATOR	231
DUEHRSSSEN DRESSING FORCEPS	74	FREER GOUGE	223
DUMONT FORCEPS	78-79	FREER SEPTUM ELEVATORS RASPARTORY	306
DUPLAY SPONGE & DRESSING FORCEPS	119	FREER TONSIL KNIFE	305
DUPLAY SPONGE FORCEPS	121	FRENCH TUNING FORK	291
DUPLAY TENACULUM FORCEPS	366	FRENCH-EYE NEEDLE HOLDERS T.C	137
DUPLEX, STETHOSCOPE	.01	FRICKE ARTERY FORCEPS	115
DUPLEX-BABY STETHOSCOPE	.01	FRIEDMANN BONE RONGEUR	246
DURADISSECTOR	329	FRIEDMANN RETRACTOR	359
DURANTE TISSUE GRASPING FORCEPS	73	FRITCH RETRACTOR	187
DUST BIN	397	FRONT & SIDE WIRE CUTTER	261
DUVAL GRASP FORCEPS	341	FRYKHOLM BONE RONGEUR	253
DUVAL INTESTINAL & TISSUE GRASPING CLAMP FORCEPS T.C	343	FUNNAL	397
DUVAL TISSUE GRASPING FORCEPS	342		
DUVAL-COLLIN GRASP FORCEPS	341		
E		G	
EISELSBERG-MATHEIU NEEDLE HOLDERS T.C	149	GALI	396
ELLIOT OBSTETRICAL FORCEPS	378	GALLAHER NASAL SAW	310
EMMET FISTULA HOOK	371	GARRIGUE WEIGHTED VAGINAL SPECULUM	356
EMMET SPONGE & DRESSING FORCEPS	121	GELLHORN BIOPSY FORCEPS	367
ENDOSCOPE BASKET	398	GELPI SKIN & VEGINAL RETRACTOR	203
ENEMA CANE	397	GELPI-LOKHITE RETRACTOR	198, 203
ENGEL PLASTER SAW	59	GEMINI MIXTER HAEMOSTATIC FORCEPS	110
ENGL. MODELL TOWEL FORCEPS	112	GERSTER BONE HOLDING CLAMP	264
ENT-DEAN SCISSORS	40	GERSTER-LOWMANN BONE CLAMP	264
ENT-DEAN SCISSORS T/C INSERT	65	GIGLE WIRE SAW	324
EPPENDORFER BIOPSY AND SPECIMEN FORCEPS	369	GIGLE-STRULLY HANDLE FOR WIRE SAW	324
ESMARCH KNIFE BRUNS SCISSORS	55	GILLIES NEEDLE HOLDERS	129
ESMARCH SCISSORS	55	GILLIES NEEDLE HOLDERS T.C	139
EUFRADE PASQUE T.C NEEDLE HOLDERS	140	GILLIES SKIN HOOK	159
EVANS PELVIC NEEDLE DRESSING FORCEPS T.C	87	GILLIES TISSUE FORCEPS	70
EVE TONSIL SNARE	305, 318	GILLIES TISSUE FORCEPS T.C	88
EXTRA 1 1/4" NYLON FACE	215	GLENOD PERFORATING FORCEPS	276
F		GOLET RETRACTOR	190
FANSLER OPERATING INTESTINAL RECTAL SPECULUM	350	GOLDMAN SRPTUM DISPLACER	307
FARABEUF BONE HOLDING FORCEPS	268	GOLDMAN-FOX SUPER CUT SCISSORS	61
FARABEUF ELEVATOR	233	GOLDMANN-FOX OPERATING SCISSORS T/C INSERT	65
FARABEUF RETRACTOR	179	GOOD SCISSORS	44
FARABEUF-COLLIN ELEVATOR	233	GOSSET BLADDER RETRACTOR	390
FARABEUF-LAMBOTTE BONE HOLDING FORCEPS	268	GOSSET RETRACTOR	204
FARR WIRE REFRACTOR	196	GOUGE	217, 223
FARRELL PROBE	158	GRADLE CILIA FORCEPS	80
FARRELL APPLICATOR	294	GRADUATED METAL RULER JAMESON CALIPER	13
FAURE HAEMOSTATIC TISSUE FORCEPS	108	GRAEFE DRESSING FORCEPS	77
FAURE UTERINE BIOPSY FORCEPS	368	GRAEFE FIXATION FORCEPS	77
FAVALORO CORONARY	40	GRAEFE FORCEPS	77
FEILCHENFELD FORCEPS	81	GRAEFE TISSUE FORCEPS	77
FEIN COTTON APPLICATOR	21	GRAVE VAGINAL SPECULUM	352
FENESTRATED CUPPED GRASPING FORCEPS	323	GRAVES VAGINAL SPECULUM	353
FERGUSON-MOON RECTAL RETRACTORS	192	GRAVES VAGINAL SPECULUM LEEP / LIETZ	353
FERGUSON BONE HOLDING FORCEPS 267		GREEN-ARMYTAG UTERINE ELEVATING FORCEPS	379
FERGUSON SUCTION TUBES	17	GROSS MAIER DRESSING FORCEPS	117-119
FERGUSON TUBING CLAMP	115	GROSS MAIER DRESSING SPONGE & DRESSING FORCEPS	118
FERGUSON-ACKLAND MOUTH GAG	315	GOSSET ABDOMINAL RETRACTORS	208
FERRIS SMITH MICRO KERRISON LAMINECTOMY RONGEURS	334-335	GRUBER EAR SPECULUM	290
FERRIS SMITH MICRO KERRISON LAMINECTOMY RONGEURS DOWNWARD	336	GUMCO CIRCUMCISION CLAMP	389
FERRIS SMITH MICRO KERRISON LAMINECTOMY RONGEURS UPWARD	336	GUTHRIE HOOKLET	159
FERRIS-SMITH INTERVERTEBRAL DISC RONGEURS	335	GUTMANN SECRETIONS SCOOP	388
FERRIS-SMITH TISSUE FORCEPS	73	GUYON SOUND SET IN METAL CASE	385
FIBULA BONE HOLDING FORCEPS	276	GUYON URETHRAL BOUGIES AND DILATING SOUNDS	386
FINGER NAIL DRILL	240		
H		H	
		HAEMOSTATIC FORCEPS	104
		HAEK MALLETS	214

INDEX



Index | Index
indice | indice

DESCRIPTION	PAGE #	DESCRIPTION	PAGE #
HAKANSSON BONE RONGEUR	254	I	
HALLE NERVE DURAHOOK	327	INCISION OPERATING SCISSORS	31
HALLE SCISSORS	44	INDO BOX ROUND	396
HALSEY NEEDLE HOLDERS	129, 150	INDO BOX WITH SILVER FRAME	394
HALSEY NEEDLE HOLDERS T.C	139, 141	INGE RETRACTOR	339
HALSTED HAEMOSTATIC FINE POINT FORCEPS	92	INITIAL INCISION RETRACTOR	207
HALSTED HAEMOSTATIC FINE POINT TISSUE FORCEPS	92	INSERT DRILL SLEEVE	285
HALSTED HAEMOSTATIC FORCEPS	92, 100	INSTRUMENT BOILER	393
HALSTED HAEMOSTATIC TISSUE FORCEPS	92	INSTRUMENT BOILER ELECTRIC	393
HALSTED-MOSQUITO HAEMOSTATIC FORCEPS	89	INSTRUMENT BOILER WITH STAND	393
HAJEK HAMMER	215	INSTRUMENT TRAY WITH COVER	392
HAND DRILL	281	INSTRUMENT TRAY WITHOUT COVER	394
HANK DILATOR	363	INTRACARDIAC NEEDLE HOLDER	151
HANK DILATOR SET	363	INTRACARDIAC NEEDLE HOLDERS T.C	136
HARD WIRE CUTTER CUTS	262	IOWA TENACULUM FORCEPS	366
HARRINGTON EXTRADEEP RETRACTOR	189	IOWA SUCTION TUBE	19
HARRINGTON RETRACTOR	188	IRIS SCISSORS	37
HARRINGTON SPLANCHNIC RETRACTOR	189	IRIS SUPER CUT SCISSORS	61
HARTMAN EAR FORCEPS	297	IRIS TISSUE FORCEPS	71
HARTMANN BONE RONGEUR	248	IVES-FANSLER ANOSCOPE INTESTINAL RECTAL SPECULUM	351
HARTMANN EAR FORCEPS	297	IVES-FANSLER RECTAL SPECULUM	348
HARTMANN EAR POLYPUS FORCEPS	296		
HARTMANN EUSTACHIAN CATHETERS	18	J	
HARTMANN NASAL POLYPUS AND SEPTUM FORCEPS	303	JACKSON BURROWS RETRACTOR	203
HARTMANN NASAL SPECULUM	299	JACKSON INTERVERTEBRAL DISC RONGEURS	333
HARTMANN TUNING FORK	291-292	JACKSON LARYNGEAL FORCEPS	316
HARTMANN-HALLE NASAL SPECULUM	299	JACKSON SPECULUM & RETRACTOR	355
HARTMANN-HOFFMANN EAR FORCEPS	297	JACOB'S CHUCK HAND DRILLS	281
HARTMANN-NOYES EAR FORCEPS	297	JACOBS HAND DRILL	281
HARTMANN-WEINGARTNER EAR FORCEPS	297	JACOBS UTERINE VULSELLUM FORCEPS	367
HARTMANN-WULLSTEIN EAR FORCEPS	297	JACOBSON HEAVY NEEDLE HOLDERS	151
HAYES HAND RETRACTOR	236	JACOBSON HEAVY STYLE NEEDLE HOLDERS T.C	147
HEANEY/BALLANTINE HAEMOSTATIC FORCEPS	103	JACOBSON NEEDLE HOLDERS T.C	136, 146
HEANEY ATRAUMATA HYSTERECTOMY FORCEPS	109	JAKO-CHERRY MICRO LARYNGOSCOPE	321
HEANEY HAEMOSTATIC FORCEPS	105	JAMESON NEEDLE HOLDERS	127
HEANEY MODIF. HAEMOSTATIC FORCEPS	105	JANSEN BONE RONGEUR	246
HEANEY NEEDLE HOLDERS	128	JANSEN CURETTE	230
HEANEY NEEDLE HOLDERS T.C	143	JANSEN DRESSING FORCEPS	317
HEANEY-GYNE NEEDLE HOLDERS T.C	143	JANSEN RETRACTOR	197
HEANEY-KANTER HAEMOSTATIC FORCEPS	105	JANSEN BONE RONGEUR	246
HEATH MALLET, HEAVYWEIGHT	216	JENNINGS MOUTH GAG	315
HEATH MALLET	215	JESBURG ESOPHAGOSCOPE	323
HEATH VASCULAR SCISSORS	39	JOHNSON NEEDLE HOLDERS	131
HEGAR UTERINE DILATOR	362	JOLL (FRIEDMAN) THYROID- AND VEGINAL RETRACTOR	203
HEGAR UTERINE DILATOR	363	JONES/PERFORATING TOWEL FORCEPS	112
HEGAR UTERINE DILATORS 8 SET W/ROLL	363	JOPSON-HORNE COTTON APPLICATOR	21
HEGEMANN-DIETHRICH VASCULAR SCISSORS	38	JOSEPH NASAL SAW	308
HEGENBARTH TISSUE FORCEPS	83	JOSEPH OPERATING SCISSORS T/C INSERT	66
HEIFETZ, BRAIN SPATULA	325	JOSEPH OPERATING, DISSECTING SCISSORS	36
HEISS RETRACTOR	196	JOSEPH RASP	308
HEISTER MOUTH GAG	315	JOSEPH SEPTUM ELEVATORS RASPATORY	306
HELFERICH-BIER SAW	211	JOSEPH-MASING SEPTUM ELEVATORS RASPATORY	306
HENNING PLASTER CAST SPREADER	59	JUDD MASSON BLADDER RETRACTOR	390
HENROTIN WEIGHTED VAGINAL SPECULUM	356	JUDD-ALLIS TISSUE FORCEPS	340
HERRICK HAEMOSTATIC FORCEPS	102	JULIAN NEEDLE HOLDERS T.C	144
HERTZLER RETRACTOR	204		
HERZ TENDON SEIZING FORCEPS	122	K	
HERZFELD RETRACTOR	167	KALLMORGEN SPECULUM & RETRACTOR	355
HEX HANDLE OSTEOTOME	221	KALT NEEDLE HOLDERS	134
HEXAGONAL HEAD	282	KALT NEEDLE HOLDERS T.C	147
HEY GROVES BONE HOLDING FORCEPS	269	KANE OBSTETRICAL FORCEPS	379
HEYMANN NASAL DRESSING FORCEPS	304	KAYE ROUND SCALPEL HANDLE	24
HEYMANN SCISSORS	43	KAYE-MILLARD RETRACTOR	190
HEYMANN-KNIGHT NASAL POLYPUS AND SEPTUM FORCEPS	303	KELLY HAEMOSTATIC FORCEPS	90
HEYWOOD SMITH SPONGE FORCEPS	121	KELLY INTESTINAL RECTAL SPECULUM	349
HEYWOOD-SMITH SPONGE & DRESSING FORCEPS	123	KELLY OPERATING, DISSECTING SCISSORS	36
HIBBS RETRACTOR	238	KELLY OPERATING, DISSECTING SCISSORS T/C INSERT	65
HILL FERGUSON RECTAL RETRACTORS	192	KELLY PROCTOSCOPE INTESTINAL RECTAL SPECULUM	351
HIRSCHMAN ANOSCOPE INTESTINAL RECTAL SPECULUM	351	KELLY RETRACTOR	186, 192, 194
HIRSCHMANN INTESTINAL RECTAL SPECULUM	349	KELLY RETRACTORS RICHARDSON RETRACTORS	192
HOEN NERVE DURAHOOK	327	KELLY SPONGE & DRESSING FORCEPS	122
HOHMANN BONE ELEVATOR	234-235	KERN BONE HOLDING FORCEPS	268
HOHMANN BONE LEVER	236	KERRISON BONE EAR RONGEURS	298
HOHMANN LONG SHANK RETRACTOR	235	KERRISON CERVICAL RONGEUR	335
HOHMANN RETRACTOR	236-237	KEVORKIAN BIOPSY AND SPECIMEN FORCEPS	369
HOHMANN-WILLIGER RETRACTOR	237	KEY HERNIA DIRECTOR	388
HOLINGER BRONCHOSCOPE	322	KIDNEY TRAY (GERMAN PATTERN)	395
HOOKLET RETRACTORS	162, 164	KIDNEY TRAY WITH COVER	395
HOOKLETS, RETRACTORS	163	KIELLAND OBSTETRICAL FORCEPS	378
HORSLEY BONE CUTTING RONGEUR FORCEPS	256	KIELLAND-LUIKART OBSTETRICAL FORCEPS	378
HORSLEY DURADISSECTOR	329	KILIAN, SEPTUM GOUGE	223
HOUZEL RETRACTOR	197	KILIAN-CLAUS SEPTUM GOUGE	223
HUDSON BRACE	280	KILLIAN NASAL SPECULUM	300
HULKA-KENWICK UTERINE ELEVATING & MANIPULATING FORCEPS	382	KILLIAN SEPTUM SPECULUM	301
HUMBY DERMATOMES	29	KILLIAN SPATULA	158
HUMERAL HEAD RETRACTOR	235	KILLIAN, EUSTACHIAN CATHETERS	18
HUNT TUMOR-AND VESSEL FORCEPS	75	KILNER HOOK	159
HUNTER FORCEPS	81		



INDEX

Index | Index
indice | indice

DESCRIPTION PAGE

KILNER NEEDLE HOLDERS	130
KILNER NEEDLE HOLDERS T.C	136
KIRK MALLETS	214
KIRSCHNER EXTENSION BOWS	288
KIRSCHNER RETRACTOR	210
KIRSCHNER WIRES & STEINMANN PINS CUTTER	262
KIRSCHNER-BALFOUR RETRACTOR	210
KLAPP RETRACTOR	176
KLEINERT-KUTZ ELEVATOR AND DISSECTOR	231
KLEINERT-KUTZ BONE CUTTING FORCEPS	258
KLEINERT-KUTZ BONE RASP	213
KLEINERT-KUTZ BONE RONGEUR	254
KLEINERT-KUTZ SYNOVECTOMY RONGEUR	258
KLINIKUM BERLIN TUBING CLAMP	115
KNIFE HANDLE	23
KNIGHT NASAL POLYPUS AND SEPTUM FORCEPS	303
KNOWLES FLASTER SCISSORS	56
KNUTSON URETHROGRAPHIE-INSTRUMENTS	389
KOCHER HAEMOSTATIC FORCEPS	95
KOCHER HAEMOSTATIC FORCEPS STRONG PATTERN	95
KOCHER HOOKLET, RETRACTORS	164
KOCHER INTESTINAL FORCEPS CLAMPS	344
KOCHER RETRACTOR	169-172
KOCHER-LANGENBECK RETRACTOR	171
KOCHER-OCHSNER HAEMOSTATIC FORCEPS	98
KOCHER'S BLADDER RETRACTOR	388
KOCHER-WAGNER RETRACTOR	172
KOERTE RETRACTOR	180
KOGAN - MODIF. SPECULUM	360
KOGAN SPECULUM	360
KOLBEL SOFT TISSUE RETRACTOR	201
KONIG RETRACTOR	167
KORTE-WAGNER RETRACTOR	180
KRAUS - WILDE NASAL POLYPOUS SNARES	295
KRAUSE NASAL POLYPOUS SNARES	295
KRAUSE, TROCAR	16
KRISTELLER SPECULUM & RETRACTOR	354
KUEHNE CILIA FORCEPS	80
K-WIRE EXTRACTION PLIERS	242

L

LA FORCE ADENOTOME UNPERFORATED	314
LABORDE TRACHEA DILATOR 3 PRONG	320
LAHEY GOITER RETRACTOR	175
LAHEY NERVE DURA HOOK RETRACTOR	328
LAHEY RETRACTOR	175
LAMBERT-LOWMAN BONE CLAMP	264
LAMBOTTE BONE HOLDING FORCEPS	270
LAMBOTTE ELEVATOR	233
LAMBOTTE OSTEOTOME	221
LAMBOTTE RETRACTORS	165
LANCASTER EYE SPECULUM	196
LANDAU SPECULUM	357
LANDAU, TROCAR	16
LANDOLT OPERATING SCISSORS	31
LANE BONE HOLDING FORCEPS	269, 271
LANE BONE LEVER	236
LANE BONE PLATE HOLDING FORCEPS	273
LANE STOMACH INTESTINAL CLAMP FORCEPS	347
LANE TISSUE FORCEPS	73
LANE TISSUE GRASPING FORCEPS	343
LANGE BANDAGE SCISSORS	56
LANGE TISSUE FORCEPS	83
LANGENBECK AMPUTATION	28
LANGENBECK BONE HOLDING FORCEPS	267
LANGENBECK DISSECTING KNIVES BLADE	27
LANGENBECK RETRACTOR	173-174
LANGENBECK-RYDER NEEDLE HOLDERS T.C	149
LARGE PIN CUTTER	263
LARYNGEAL MIRRORS	319
LARYNGEAL MIRRORS HANDLE	319
LARYNGEAL MIRRORS WITH HANDLE	319
LARYNGOSCOPE HOLDER	322
LARYNGOSCOPE MILLER SET	07
LARYNGOSCOPE, ADOLESCEN.	T321
LATERAL NONCONDUCTIVE VAGINAL RETRACTOR	360
LATHBURY-FARREL PROBE	158
LAXER OPERATING SUPER CUT SCISSORS	60
LEAD HAND	241
LEEDHAM TISSUE FORCEPS	72
LEGUEU BLADDER RETRACTOR	388
LEGUEU BLADDER SPATULA	390
LEGUEU RETRACTOR	208
LEKSELL BONE RONGEUR	251
LEKSELL BONERONGEUR	254
LEKSELL-STILLE BONE RONGEUR	254
LEMPERT BONE RONGEUR	247
LEMPERT SEPTUM ELEVATORS RASPARTORY	306
LERCHE TISSUE FORCEPS	70

DESCRIPTION PAGE

LEWIN PERFORATING BONE HOLDING FORCEPS	265
LEXER GOUGE	219
LEXER CHISEL	219
LEXER GOUGE TUFFNEL HANDLE	219
LEXER MODIF. CHISEL	219
LEXER MODIF. OSTEOTOME	219
LEXER OSTEOTOME	219
LEXER OSTEOTOME FLAT	219
LEYLA SELF-RETAINING BRAIN RETRACTOR	325
L-G INTERVERTEBRAL DISC RONGEURS	331
LICHTENBERG NEEDLE HOLDERS T.C	148
LICHTWITZ ANTRUM TROCAR	16
LISTER BANDAGE PLASTER SCISSORS	55
LISTER BANDAGE PLASTER SCISSORS T/C INSERT	65
LISTER BOUGIES	385
LISTER SINUS FORCEPS COLLIN DRESSING HAEMOSTATIC FORCEPS	117
LISTER-EXCENTRIC PLASTER SCISSORS	55
LISTON BONE CUTTING RONGEUR FORCEPS	255, 259
LISTON DISSECTING KNIVES	27
LISTON KEY HORSLEY BONE CUTTING RONGEUR FORCEPS	256
LISTON-STILLE BONE CUTTING RONGEUR FORCEPS	259
LITTAUER / LITTON BONE CUTTING RONGEUR FORCEPS	255
LITTAUER CILIA FORCEPS	80
LITTAUER EAR POLYPUS FORCEPS	296
LITTAUER NASAL POLYPUS AND SEPTUM FORCEPS	303
LITTAUER STITCH SCISSORS	42
LITTLE RETRACTOR	176
LITTLE WOOD TISSUE GRASPING FORCEPS	343
LOCKE PHALANGEAL FORCEPS	265
LOCKHART-MUMMERY PROBE	156
LOCKING PLIER	244
LOCKLIN DISSECTING SCISSORS	40
LOCKWOOD GRASP FORCEPS	342
LONG CHROME HANDLE INTESTINAL RECTAL SPECULUM	351
LONG HAEMOSTATIC TISSUE FORCEPS	107
LONGE OPERATING, DISSECTING SCISSORS	31
LORENZ PLASTER SCISSORS	56
LORNA TOWEL FORCEPS	113
LOVE NERVE DURA HOOK RETRACTOR	328
LOVE-GRUENWALD INTERVERTEBRAL DISC RONGEURS	330, 333
LOVES BOX	392
LOWER HAEMOSTATIC FORCEPS	104
LOWMANN BONE CLAMP	264
LUBET-BARBON NASAL POLYPUS AND SEPTUM FORCEPS	303
LUC NASAL CUTTING FORCEPS	304
LUCAE / ENT DRESSING FORCEPS	75
LUCAE DRESSING FORCEPS	317
LUCAE HOOKLET & SKIN HOOKS	160
LUCAE HOOKLET	294
LUCAE MALLETS	214
LUCAE TUNING FORK	291
LUCAS CHISEL	217
LUCAS CURETTE	230
LUCAS GOUGE	217
LUER BONE RONGEUR	246
LUER RETRACTOR	177
LUER, TROCAR LUER LOCK ADAPTER	15
LUER-KOERTE PROBE	384
LUER-STANDARD TRACHEA TUBES	320
LUER-STILLE BONE RONGEUR	253
LUETHY-BECK NEEDLE HOLDERS T.C	149

M

MACPHAIL NEEDLE HOLDERS	132
MAGILL CATHETER INTUBATING FORCEPS	04
MAGILL, SUCTION TUBE	19
MALLEABLE RETRACTOR	195
MALLEOLLAR BONE HOLDING FORCEPS	276
MALLET #49	216
MALLET MALLETS	214
MALLET, LIGHTWEIGHT	216
MALTZ NASAL SAW	310
MALTZ RASP	308
MANNERFELT HOOK	160
MANNERFELT HOOKLET RETRACTORS	168
MANNERFELT MODIF. BALLENGER CHISEL	223
MANNERFELT-LANGENBECK HOOK	160
MARBACH PLASTER SCISSORS	57
MARKHAM/MEYERDING RETRACTOR	197
MARKWALDER BONE CUTTING RONGEUR FORCEPS	257
MARQUARDT BONE RONGEUR	249
MARSCHIK TONSIL SEIZING FORCEPS	316
MARTEL HAEMOSTATIC FORCEPS	116
MARTIN CARTILAGE BONE HOLDING CLAMP FORCEPS	272
MARTIN PELVIMETER, OBSTETRICAL FORCEPS	376
MARTIN UTERINE SOUND	361
MARTINI CURETTE	229
MASING PERIOSTEAL SEPTUM ELEVATORS	307
MASS. GENERAL HOSPITAL NEEDLE HOLDERS	127

INDEX



Index
indice

DESCRIPTION	PAGE #
MASSON NEEDLE HOLDERS T.C	145
MASSON-LUETHY NEEDLE HOLDERS	129
MATHIEU NEEDLE HOLDERS	131
MATHIEU RECTAL SPECULUM	348
MATHIEU RETRACTOR	177
MATHIEU-RYDER NEEDLE HOLDERS T.C	148
MATHIEU-RYDER VASCULAR NEEDLE HOLDERS T.C	148
MATHIEU-STILLE NEEDLE HOLDERS T.C	147
MATSON MENISCOTOMY KNIFE	239
MAUNDER MOUTH GAG	315
MAYFIELD BONE RONGEUR	250
MAYO DISSECTING & GYNECOLOGICAL SCISSORS	32
MAYO DISSECTING & GYNECOLOGICAL SCISSORS T/C INSERT	64
MAYO ROCHESTER NEEDLE HOLDERS	132
MAYO UTERINE SOUND	361
MAYO-BLAKE GALL STONE FORCEPS	387
MAYO-COLLIN RETRACTOR	179
MAYO-HARRINGTON DISSECTING & GYNECOLOGICAL SCISSORS	32
MAYO-HEGAR NEEDLE HOLDERS	124, 151
MAYO-HEGAR NEEDLE HOLDERS T.C	138, 145
MAYO-NOBLE DISSECTING & GYNECOLOGICAL SCISSORS	32
MAYO-ROBSON INTESTINAL FORCEPS CLAMPS	344
MAYO-STILLE DISSECTING & GYNECOLOGICAL SCISSORS	32
MAYO-STILLE DISSECTING & GYNECOLOGICAL SCISSORS T/C INSERT	64
MC INDOE BONE CUTTING FORCEPS	258
MC INDOE BONE CUTTING RONGEUR FORCEPS	258
MC INDOE DRESSING FORCEPS T.C	88
MCGEE LATERAL VAGINAL RETRACTOR	360
MC-INTOSH LARYNGOSCOPE FIBER OPTIC SET	05
MC-INTOSH LARYNGOSCOPE SET	06
MCKENZIE CLIP APPLYING FORCEPS	326
MCLEAN OBSTETRICAL FORCEPS	378
MEAD BONE RONGEUR	248
MEAD MALLET	216
MEASURING GAUGE	289
MEASURING JUG	396
MEDICINE CUP GRADUATED	396
MEMORAL HEAD EXTRACTOR HAND DRILLS	281
MENISCUS CLAMP	266
MESH BASKET	398
MESH BASKET WITH PERFORATED	398
METZENBAUM NEEDLE HOLDERS	131
METZENBAUM NEEDLE HOLDERS T.C	147
METZENBAUM OPERATING SCISSORS T/C INSERT	63
METZENBAUM OPERATING, DISSECTING SCISSORS	33
METZENBAUM-FINO OPERATING SCISSORS T/C INSERT	64
METZENBAUM-FINO SCISSORS	35
METZENBAUM-NELSON OPERATING SCISSORS T/C INSERT	63
METZENBAUM-NELSON SCISSORS	34
MEYERDING FINGER RETRACTOR	176
MEYERDING RETRACTOR	190, 201, 238
MICHEL FORCEPS	83
MICHEL MOVEABLE MIRROR	319
MICHEL TISSUE FORCEPS	83
MICRO ADSON TISSUE FORCEPS	85
MICRO ADSON TISSUE FORCEPS TC	84
MICRO ADSON DRESSING FORCEPS TC	84
MICRO CUP FORCEPS	297, 330
MICRO DERF NEEDLE HOLDERS T.C	142
MICRO EJECTOR KERRISON LAMINECTOMY RONGEURS	334, 338
MICRO NEEDLE HOLDERS	134, 151
MICRO RYDER NEEDLE HOLDERS T.C	135
MICRO SCISSORS	50
MICRO SURGICAL NEEDLE HOLDERS T.C	144
MICROVASCULAR NEEDLE HOLDERS	151
MICROVASCULAR NEEDLE HOLDERS T.C	135
MIDDELDORF RETRACTOR	175
MIDDLETON-JANSEN SEPTUM FORCEPS	312
MIKULICZ HAEMOSTATIC TISSUE FORCEPS	100
MIKULICZ HAEMOSTATIC TISSUE FORCEPS	107-108
MIKULICZ RETRACTOR	186, 188
MILLER ALVEOTOMY FILE	213
MILLER RETRACTOR	162
MILLER-COLBURN BONE FILE	213
MILLIGAN RETRACTOR	197
MILLIN BLADDER NECK SPREADER	390
MILLIN SUCTION TUBE	388
MINI-NOVAK ASPIRATING CURETTE	372
MINI-TISCHLER BIOPSY AND SPECIMEN FORCEPS	370
MINI DRILL SLEEVE	284
MINI LEXER CHISEL	220
MINI LEXER OSTEOTOME	220
MINI-HOHMANN BONE ELEVATOR	236
MINI-LAMBOTTE OSTEOTOME	221
MINI-ROUX RETRACTOR	178
MIXTER FORCEPS	104
MIXTER FORCEPS, LEE MODIF	104
MIXTER GALL STONE FORCEPS	387
MIXTER HAEMOSTATIC GALL DUCT FORCEPS	104
MIXTER-O'SHAUGNESSY HAEMOSTATIC FORCEPS	101

DESCRIPTION	PAGE #
MOD. BONN SCISSORS	44
MOD. MARTIN DRESSING FORCEPS	68
MOD. MICHEL FORCEPS	83
MOD. USA, DRESSING FORCEPS	68
MOD. USA, TISSUE FORCEPS	68
MOD. WIEN NASAL SPECULUM	301
MODEL USA CAST SPREADER PLASTER	59
MODELL PICCOLO PROBE	158
MODIFIED-USA PLASTER SCISSORS	57
MÖELTGEN CALIPER	13
MOGEN CIRCUMCISION CLAMP	389
MOLLISON RETRACTOR	197
MOLT MOUTH GAG	315
MOORE DRILL AND BIT SET COMPLETE	279
MORGEN PROCTOSCOPE INTESTINAL RECTAL SPECULUM	351
MORRIS RETRACTOR	194
MORTISING CHISEL	283
MOSQUITO HAEMOSTATIC FORCEPS	89, 99
MOYNIHAN PROBE	384
MURPHY RETRACTORS	165
MUSEUX TENACULUM FORCEPS	367
MUSEUX TONSIL HOLDING FORCEPS	316
MYRTLE LEAF PROBE	157

N

NAEGELE OBSTETRICAL FORCEPS	377
NAIL EXTRACTING FORCEPS	240
NAIL EXTRACTOR	245
NAIL NIPPERS	46
NAIL SCISSORS	41
NAIL SPLITTING FORCEPS	240
NASAL POLYPUS SNARES	295
NEEDLE CASE	394, 396
NEEDLE NOSE PLIERS	242
NEEDLE-NOSE LOCKING PLIERS	245
NEGUS HAEMOSTATIC FORCEPS	99
NEIVERT NEEDLE HOLDERS	130
NEIVERT NEEDLE HOLDERS T.C	143
NEIVERT-ANDERSON OSTEOTOME	225
NELATON PROBE	156
NELATON PROBES & DIRECTORS	20
NELSON TISSUE FORCEPS	73
NELSON TROCER THORAX	16
NEURO-DUOFLEX HAMMER	02
NEUTRAL & LOAD DRILL GUIDE	284
NEUFIELD HAMMER	214
NEW ORLEANS NEEDLE HOLDERS	128
NEW ORLEANS NEEDLE HOLDERS T.C	135
NO SCALPEL VASECTOMY HEMOSTAT FORCEPS	388
NO SCALPEL VASECTOMY RINGED FORCEPS CLAMPS	388
NON-PERFORATING TOWEL FORCEPS	114
NORFOLK & NORWICH RETRACTOR	201
NORTHBENT STITCHES SCISSORS	42
NOSE PLIERS	243
NOTO SPONGE & DRESSING FORCEPS	122
NOVAK ASPIRATING CURETTE	372
NOYES MICRO SCISSORS	50
NOYES NASAL DRESSING FORCEPS	304
NOYES SCISSORS	49
NYLON CAPS LEFT & RIGHT	216
NYLON HEAD MALLET	215

O

O'BRIEN VASCULAR SCISSORS	39
O'SHAUGNESSY HAEMOSTATIC FORCEPS	94
O'SULLIVAN-O'CONNOR VAGINAL RETRACTOR	359
O'SULLIVAN/O'CONNOR RETRACTOR	206
OBWEGESER BLADE OSTEOTOME	226
OBWEGESER ELEVATOR	231
OBWEGESER NEEDLE	232
OBWEGESER OSTEOTOME	226
OBWEGESER-FREER ELEVATOR	231
OCHSNER FORCEPS	83
OCHSNER TROCER THORAX	16
OEHLER TISSUE FORCEPS T.C	88
OLDBERG INTERVERTEBRAL DISC RONGEURS	332
OLIVECRONA BRAIN SPATULA	325
OLIVECRONA VASCULAR SCISSORS	43
OLIVECRONA WIRE SAW	324
OLLIER RETRACTOR	175
OLSEN-HEGAR NEEDLE HOLDERS	129, 137, 145
OMBREDANNE MALLETS	215
OPERATING SCISSORS, S/S STR. T/C INSERT	62
ORTHOPEDIC MALLET	216
OSTEOTOME	217, 223

P

PACKER MOSQUITO FORCEPS	93
-------------------------	----



INDEX

Index | Index
indice | indice

DESCRIPTION	PAGE #	DESCRIPTION	PAGE #
PANTINGS BLADDER RETRACTOR	390	RESANO DRESSING FORCEPS T.C	86
PAPER DRESSING FORCEPS	75	RESECTION KNIFE	28
PARALLEL TARGET DEVICE	283	REVERDIN NEEDLE	152
PARAMETRIUM HAEMOSTATIC FORCEPS	106	REVERDIN RETRACTOR	195
PARAMETRIUM HYSTERECTOMY FORCEPS	364	REYNOLDS OPERATING SCISSORS T/C INSERT	66
PARHAM MARTIN BANDS	264	RIBBON RETRACTOR	195
PARHAM-MARTIN BONE CLAMP	264	RICHARDS MICRO NEEDLE HOLDERS	150
PARKER RETRACTOR	179	RICHARDSON EASTMAN RETRACTOR	177
PARKER-LANGENBECK RETRACTOR	179	RICHARDSON RETRACTOR	193
PARKER-MOTT RETRACTOR	179	RICHARDSON/KELLY RETRACTOR	190
PARTSCH CHISEL	217	RICHARDSON-EASTMAN RETRACTOR	193
PARTSCH GOUGE	217	RICHTER OPERATING, DISSECTING SCISSORS	36
PARTSCH MALLET	214	RICHTER-HEATH FORCEPS	83
PASSOW BONE TAMPER	226	RIECHERT FIXATION BASE	325
PATELLA MALLEOLAR FORCEPS	277	RIGHBY RETRACTOR	199
PAYR CRUSHING INTESTINAL CLAMP	346	RING CUTTER	240
PEAN HAEMOSTATIC FORCEPS SLENDER TYPE	95	RISKIN BONE RONGEUR	250
PEAPOD INTERVERTEBRAL DISC RONGEURS	333	RITTER-HALLE FORNITAL SINUS BOUGIES	311
PECK RAKE RETRACTOR	163	ROBERTS HAEMOSTATIC FORCEPS	102
PEDERSON VAGINAL SPECULUM	353	ROCHARD RETRACTOR	208
PEDERSON VAGINAL SPECULUM LEEP/LIETZ	353	ROCHESTER NEEDLE HOLDERS T.C	139
PEERS-BERTMAN TOWEL FORCEPS	114	ROCHESTER-CARMALT HAEMOSTATIC FORCEPS	99
PEET SPLINTER FORCEPS	62	ROCHESTER-OCHSNER HAEMOSTATIC FORCEPS	99
PELKMANN SPONGE FORCEPS	121	ROCHESTER-PEAN HAEMOSTATIC FORCEPS	96-97
PELTESON COTTON APPLICATOR	21	ROD BENDER	286
PELVIC REDUCTION FORCEPS ASYMMETRIC	278	ROEDER TOWEL FORCEPS	113
PELVIC REPOSITION FORCEPS	277-278	ROGERS PARAMETRIUM HYSTERECTOMY FORCEPS	364
PENFIELD DURA DISSECTOR	327	ROGGE STERILIZING FORCEPS	399
PENNINGTON / SIEZING HAEMOSTATIC FORCEPS	116	ROLLET (BLAIR) HOOKLET RETRACTORS	162
PENNINGTON SEPTUM ELEVATORS RASPARTORY	306	ROLLET HOOK FREER SKIN HOOK	159
PERCY AMPUTATION SHIELD	211	ROLLET HOOKLET RETRACTORS	162
PERFORATED BOX	392	RONGEUR #4	247
PERFORATED TRAY	393	RONGEUR #4A	247
PERIOSTEAL ELEVATOR	237	ROSE RETRACTOR	177
PERKINS RETRACTOR	199	ROSEN, SUCTION TUBE	19
PERTHES REAMERS	283	ROSER-KONIG MOUTH GAG	315
PESTALOZZA OVUM CURETTE	380	ROSS RETRACTOR	191
PHANEUF HAEMOSTATIC TISSUE FORCEPS	107	ROTTGEN-RUSKIN BONE RONGEUR	253
PIERCE ANTRUM TROCAR	16	ROUND BEDPAN	397
PIN CUTTER MEDIUM	263	ROUND KNURLED SCALPEL HANDLE	23-24
PIN CUTTER SMALL	263	ROUX RETRACTOR	178
PIN PULLER W/ GROOVE	243	ROUX-MAGNUS RETRACTOR	178
PINARD ALUMINIUM STETHOSCOPE	.01	RUBIN SEPTUM FORCEPS	312
PINARD WOODEN STETHOSCOPE	.01	RUBIO WIRE TWISTER NEEDLE HOLDERS T.C	142
PIPER OBSTETRICAL FORCEPS	377	RUSKIN BONE CUTTING RONGEUR FORCEPS	256
PLASTER SCISSORS	55	RUSKIN RONGEUR	250
PLASTER SHEARS	58	RUSKIN-LISTON BONE CUTTING RONGEUR FORCEPS	257-258
PLATE BENDER	287	RUSKIN-MINI BONE RONGEUR	254
PLATE BENDING PLIER	244	RUSSIAN-MODELL TISSUE FORCEPS	74
PLESTER RETRACTOR	199	RYDEL-SEIFFER TUNING FORK	291
PLESTER SUCTION TUBES	17	RYDER NEEDLE HOLDERS	150
POLITZER EAR SPECULUM	290	RYDER NEEDLE HOLDERS T.C	140
POTTS-SMITH DRESSING FORCEPS	69		
POTTS-SMITH DRESSING FORCEPS T.C	87	S	
POTTS-SMITH TISSUE FORCEPS	69	SACHS DURA DISSECTOR	329
POTTS-SMITH VASCULAR SCISSORS	38	SACHS NERVE ELEVATOR	231
POZZI TENACULUM FORCEPS	365	SAENGER ABORTION FORCEPS	380
PRATT HAEMOSTATIC FORCEPS	116	SAFETY SUPER CUT SCISSORS	61
PRATT RECTAL SPECULUM	348	SAILER SCISSORS	43
PRATT TENACULUM FORCEPS	366	SAMII FORCEPS	75
PRESBYTERIAN TUBING CLAMP	114	SAROOT HAEMOSTATIC FORCEPS	93
PRESTON LOGAMENTUM FLAVUM FORCEPS	266	SAROT NEEDLE HOLDERS	127
PRINCE SCISSORS	44	SAROT NEEDLE HOLDERS T.C	137
PROBE MYRTLE-SHAPED	20	SAUERBRUCH BONE RONGEUR	253
PROBE WITH EYE	20	SAUERBRUCH RETRACTOR	181
PROBE DOUBLE ENDED	20	SAW BLADE ONLY	240
PROBES WITH EYE	157	SAWYER RETRACTORS	192
PROFESSIONAL OTOSCOPE & OPHTHALMOLOGY SET	08	SCALER BOX	394
PUTTI BONE FILE	212	SCALER TRAY	394
PUTTI BONE RASP	212	SCALPEL BLADES	25
PUTTI RASP	212	SCALPEL HANDLE	24
		SCALPEL HANDLE #3	22
Q		SCALPEL HANDLE #3, #4	23
QUIRE EAR POLYPUS FORCEPS	296	SCALPEL HANDLE #3P	24
		SCALPEL HANDLE #4	22
R		SCALPEL HANDLE #4 GRADUATED	22
RABINER HAMMER	03	SCALPEL HANDLE #7	23
RAGNELL-DAVIS RETRACTOR	167	SCALPEL HANDLE / LONG ANGLED #3LA	23
RALK SPLINTER FORCEPS		SCALPEL HANDLE 3L LONG	23
RAMSAY DISSECTING FORCEPS	72	SCALPEL HANDLE 4L LONG	23
RANDALL KIDNEY STONE CLAMPS FORCEPS	381	SCALPEL HANDLE 4LA	22
RAZOR HOLLOW BLADES	28	SCALPEL HANDLE / GRADUATED #3	22
RECAMIER UTERINE CURETTE	373-374	SCHAEDEL TOWEL FORCEPS	112
REDUCTION FORCEPS	277	SCHERBACK SPECULUM	358
REIL BONE HOLDING FORCEPS	276	SCHINDLER HAEMOSTATIC TISSUE FORCEPS	105
REILL BONE REDUCTION FORCEPS	275	SCHLESINGER CERVICAL RONGEUR	335
REINER EAR SYRINGE	295	SCHLESINGER INTERVERTEBRAL DISC RONGEURS	332
REINER EAR SYRINGE SHIELD	295	SCHOENBORN RETRACTOR	167
		SCHRÖDER UTERINE SPOON	375

INDEX



Index | Index
 indice | indice

DESCRIPTION	PAGE #	DESCRIPTION	PAGE #
SCHROEDER BONE CURETTE	228	SPREADER PLASTER	59
SCHROEDER TENACULUM FORCEPS	365	SPRIT LAMP	396
SCHROEDER VULSELLUM TENACULUM FORCEPS	366	SPURLING KERRISON LAMINECTOMY RONGEURS	337
SCHROEDER-BRAUN TENACULUM FORCEPS	65	SPURLING INTERVERTEBRAL DISC RONGEURS	330, 332, 333
SCHUBERT BIOPSY FORCEPS	368	SPURLING LAMINECTOMY RONGEURS	337-338
SCHUHKNECHT RETRACTOR	198	SPUTUM MUG	397
SCHULZE-BERGMANN INTESTINAL RECTAL SPECULUM	349	S-SHAPED RETRACTOR	185
SCHUMACHER BIOPSY FORCEPS	368-369	ST. CLAIR-THOMSON ADENOID CURETTE	313
SCHUMACHER PLASTER SCISSORS	57	STACKE SPATULA	158
SCHUMACHER STERNUM SHEARS	262	STAGBEETLE BONE REDUCTION FORCEPS	265
SCHWARTZ VESSEL CLIP	326	STANDARD DRESSING FORCEPS	67-68
SCHWARZ NASAL SPECULUM	300	STANDARD DRESSING FORCEPS T.C	86
SCOVILLE NERVE RETRACTOR	238	STANDARD OPERATING SCISSORS	30
SCOVILLE-RICHTER RETRACTOR	207	STANDARD OPERATING SUPER CUT SCISSORS	60
SCREW DEPTH GAUGES	289	STANDARD TISSUE FORCEPS	67
SCREW DRIVERS	282	STAUDE - MOORE TENACULUM FORCEPS	365
SEDILLOT ELEVATOR	232	STELLBRINK BONE RONGEUR	247
SEGOND MYOMA KNIFE FISTULA HOOK	371	STERILIZING DRUMS	391
SEGOND-LANDAU HAEMOSTATIC FORCEPS	105	STERNBERG RETRACTOR	166
SEIFFERT PROBE	158	STERNUM NEEDLE HOLDERS T.C	142
SELETZ-GELPI RETRACTOR	198	STEVENS OPERATING SCISSORS T/C INSERT	66
SELLHEIM OBSTETRICAL LEVER	378	STEVENS SCISSORS	41
SELVERSTONE INTERVERTEBRAL DISC RONGEURS	332	STEVENS TENOTOMY SUPER CUT SCISSORS	61
SEMB BONE CUTTING RONGEUR FORCEPS	256	STEVENS TISSUE FORCEPS	77
SEMB BONE HOLDING FORCEPS	267, 271	STIEGLITZ FORCEPS WITH MEGNIFYING MIRRORS	82
SEMB BONE RONGEUR	253	STIEGLITZ SPLINTER FORCEPS	82
SEMKEN DRESSING FORCEPS	88	STILLE BONE RONGEUR	251, 254
SEMKEN TISSUE FORCEPS T.C	88	STILLE CHISEL	218, 222
SEMM ABDOMINAL RETRACTORS	209	STILLE GOUGE	218, 222
SEMM VAGINAL SPECULUM	352	STILLE HAEMOSTATIC FORCEPS	103
SENN RETRACTOR	166	STILLE OSTEOTOME	218, 222
SENN-GREEN RETRACTOR	167	STILLE PATTERN DRILL SET	279
SENNING NEEDLE HOLDERS	128	STILLE PLASTER SHEAR	58, 262
SENNING NEEDLE HOLDERS T.C	136	STILLE-BARRAYA TISSUE FORCEPS	74
SENN-MUELLER RETRACTOR	166	STILLE-HORSLEY BONE CUTTING FORCEPS	259
SERRA GIGLI	211	STILLE-LEUR RONGEUR	252
SEQUESTRUM (NIRCOSIS) BONE HOLDING FORCEPS	267	STILLE-LISTON BONE CUTTING RONGEUR FORCEPS	256, 259
SEUTIN PLASTER SCISSORS	57	STILLE-LUER ECHLIN DUCKBILL RONGEUR	252
SHAVING MUG	397	STILLE-LUER RONGEUR FORCEPS	251
SHEEHAN OSTEOTOME	225	STILLE-RUSKIN BONE RONGEUR	250
SHORTBENT STITCH SCISSORS	42	STITCHES SCISSORS	42
SHOULDER PENETRATING GOUGE	223	STOCKMANN PENILE CLAMP	389
SHOULDER PERCUSSION AWL	265	STONE TISSUE FORCEPS	70
SIDE CUTTER	261	STRANDELL-STILLE RETRACTOR	167
SIDE PIN CUTTER	282	STRASSMANN KIDNEY ELEVATING STONE CLAMPS FORCEPS	382
SIEGEL ROUND SCALPEL HANDLE #3	22	STRATTE NEEDLE HOLDERS T.C	139
SILVER DERMATOMES	29	STRUMPEL EAR FORCEPS	297
SILVER RHINOPLASTIC CHISEL	225	SUBACROMION SPREADER	271
SIMON BONE CURETTE	228	SUCTION TUBE	323
SIMON DISSECTING KNIVES	27	SUCTION TUBE, GUIDE NEEDLE	19
SIMON FISTULA HOOK	371	SUCTION TUBE, GUIDE NEEDLE LANCET TIP	19
SIMON FISTULA HOOK, TWO PRONG	371	SULLIVAN SCISSORS	44
SIMPSON - BRAUN OBSTETRICAL FORCEPS	377	SUPRA CUT DISTRACTION SCREW	325
SIMPSON - LUIKART OBSTETRICAL FORCEPS	377	SUPRA CUT DISTRACTION SCREW DRIVER	325
SIMPSON OBSTETRICAL FORCEPS	377	SYSTRUNK SCISSORS	45
SIMPSON UTERINE SOUND	361	SYPERT RONGEUR	254
SIMS DISSECTING & GYNECOLOGICAL SCISSORS	37		
SIMS RECTAL SPECULUM	348	T	
SIMS SPECULUM & RETRACTOR	355	TAKAHASHI NASAL CUTTING FORCEPS	304
SIMS UTERINE CURETTE	374	TAP SLEEVE	284
SIMS UTERINE SOUND	361	TARNIER OBSTETRICAL FORCEPS	378
SIMS-MAIER SPONGE & DRESSING FORCEPS	119	TAYLOR HAMMER	02
SINGLEY-TUTTLE FORCEPS	74	TAYLOR RETRACTOR	237-238
SINUSCOPY, TROCAR	15	TAYLOR SPINAL RETRACTORS	177
SKENE TENACULUM FORCEPS	365	TEALE HERNIA DIRECTOR	388
SLOTTED HAMMER	286	TEALE TENACULUM FORCEPS	367
SMELLIE OBSTETRICAL FORCEPS	379	TENDON HOOKS RETRACTOR	176
SMILLIE MENISCOTOMY KNIFE	239	TENDON SEIZING FORCEPS	121
SMITH (MOD. USA) PLASTER SCISSORS	56	TENDON TUNELLING FORCEPS	241
SMITH PETERSON GOUGE	218	T-HANDLE HAND DRILLS	281
SMITH PETERSON OSTEOTOME	218	THOLE PELVIMETER, OBSTETRICAL FORCEPS	376
SMITH-BLUE INTESTINAL RECTAL SPECULUM	349	THOMS-GAYLOR BIOPSY FORCEPS	367
SMITH-PETERSEN CHISEL	222	THOMSON WALKER BLADDER RETRACTOR	390
SMITH-PETERSEN GOUGE	222	THOMSON-WALKER'S PENILE CLAMPS	112
SMITH-PETERSEN OSTEOTOME	222	THUDICHUM (GOLDSMITH) NASAL SPECULUM	299
SMITH-PETERSON LAMINECTOMY RONGEUR	249	TIECK-HALLE NASAL SPECULUM	300
SMITHWICH DURADISSECTOR	329	TILLEY NASAL POLYPUS AND SEPTUM FORCEPS	303
SMITHWICK CLIP APPLYING FORCEPS	326	TISCHLER - MORGAN BIOPSY AND SPECIMEN FORCEPS USA MODELL	370
SMITHWICK NERVE DURA HOOK	327	TISSUE & DRESSING FORCEPS	69
SOFIELD RETRACTOR	177	TISSUE FORCEPS	71
SOLID COPPER HEAD MALLET	215	TOENNIS DURA DISSECTOR	329
SOMER KIDNEY ELEVATING STONE CLAMPS FORCEPS	382	TOENNIS HOOK & SKIN HOOK	159
SPATULA	158	TOENNIS NEEDLE HOLDERS	132
SPECIMEN AND ASPIRATING CURETTE	372	TOENNIS NERVE DURA HOOK	327
SPENCER STITCH SCISSORS	42	TOHOKU TOWEL FORCEPS	113
SPENCER-WELLS HAEMOSTATIC FORCEPS SLENDER TYPE	95	TONSIL KNIFE	305
SPINAL DISTRACTOR	339	TOWNLEY CALIPER	13
SPLINTER FORCEPS	81-82	TOYNBEE EAR SPECULUM	290
SPLIT LAMP	395	TRACHEAL RETRACTOR	161
SPRATT BONE CURETTE / HOLLOW HANDLE	227		



INDEX

Index | Index
indice | indice

DESCRIPTION	PAGE #
TRAUBE HAMMER	03
TRAVERS RETRACTOR	199
TRELAT VAGINAL SPECULUM	353
TREVES TISSUE FORCEPS	72
TRIANGULAR POSITIONING PLATE	289
TROELTSCH DRESSING FORCEPS	317
TROEMNER HAMMER	02
TROEMNER-SIMPLEX HAMMER	02
TROELTSCH EUSTACHIAN CATHETERS	18
TROUSSEAU TRACHEA DILATOR 2 PRONG	320
TROUTMAN MICRO SCISSORS	49
TUBING CLAMP	114
TUBING CLAMP WITH PROTECTOR	115
TUCKER MID-LIGHTED SIDE SLIDE	321
TUCKER MID-LIGHTED SIDE SLIDE LARYNGOSCOPE	321
TUFFIER/HABERER RETRACTOR	195
TUFFIER HAEMOSTATIC FORCEPS	116
TUFFIER RETRACTOR	187
TUFFIER RETRACTOR	188
TUFFIER TISSUE FORCEPS	341
TUNING FORKS NEUROL WITH HAMMER	291
TURNBULL NIPPERS	46
TURNER-DOYEN RETRACTORS	191
TWIST DRILLS - REAMERS - FORCEPS	283
TYDING TONSIL SNARE	318
U	
U.S. ARMY PATTERN CHISEL	217
UCKERMANN TRACHEA TUBES	320
UCKERMANN, TROCAR	15
ULRICH BONE HOLDING FORCEPS	269
ULRICH BONE HOLDING SELF RETAINING FORCEPS	269
ULRICH SPONGE FORCEPS	120
ULTRA-MICRO NEEDLE HOLDERS	150
UNI-RANDALL ASPIRATING CURETTE	372
UNIVERSAL ABDOMINAL TROCER SET	15
UNIVERSAL BONE RONGEUR	248
UNIVERSAL PARAMEDIC SHEAR	51-52, 54
UNIVERSAL PARAMEDIC SHEAR PROB END	53
UNIVERSAL ROD BENDER	286
UNIVERSAL HAMMER	215
UNIVERSAL SCISSORS	51-54
UNIVERSAL WIRE CUTTING SCISSORS	45
URINAL - FEMALE	397
URINAL - MALE	397
URO-TANGENTIAL GALL STONE FORCEPS	387
US-ARMY RETRACTOR	177
UTILITY STERILIZING FORCEPS	399
UTILITY TECHNICAL FORCEPS PLIERS	243
V	
VALLEIX UTERINE SOUND	361
VAN BUREN SEQUESTERUM FORCEPS	267
VAN BUREN URETHRAL SOUND	385
VAN DOREN BIOPSY FORCEPS	368
VASCULAR SCISSORS	38
VEBRUGGE SELF-CENTERING BONE HOLDING FORCEPS	273
VEBRUGGE BONE HOLDING FORCEPS	272-274
VERNIER CALIPER	13
VERNON-DAVID INTESTINAL RECTAL SPECULUM	350
VIENNA SPECULUM	300
VITAL HEAVY DUTY PLIERS T.C	243
VITAL WIRE CUTTER	260
VITAL WIRE EXTRACTION PLIERS T.C	243
VOLKMAN RETRACTOR	166
VOLKMAN BONE CURETTE	227
VOLKMAN CURETTE	229
VOLKMAN RETRACTORS	165
VOLKMAN RETRACTORS	180
VON GRAEFE STRABISMUS & SKIN HOOKS	160
W	
WACHENFELDT TISSUE FORCEPS	83
WAGENER HOOKLET & SKIN HOOKS	160
WAGENER HOOKLET BUTTONEED	294
WALDMANN PLASTER SCISSORS	56
WALDMANN SCISSORS	57
WALLICH OVUM CURETTE	380
WALTON-LISTON BONE CUTTING RONGEUR FORCEPS	258
WANGENSTEEN DRESSING FORCEPS	70
WANGENSTEEN DRESSING FORCEPS T.C.	87
WANGENSTEEN NEEDLE HOLDERS	131
WANGENSTEEN NEEDLE HOLDERS T.C	138
WARTENBERG PINWHEEL	03
WASH BASIN	395
WASSMUND RETRACTOR	176
WATSON DERMATOMES	29
WATSON-CHEYNE RASPARTORY	307

DESCRIPTION	PAGE #
WATSON-WILLIAMS NASAL CUTTING FORCEPS	304
WAUGH DRESSING FORCEPS	72
WEBER AESTHESIOMETER	01
WEBSTER NEEDLE HOLDER	125, 150
WEBSTER NEEDLE HOLDERS T.C	144, 145
WECKER SCISSORS	49
WEIL NASAL CUTTING FORCEPS	304
WEINBERG VAGOTOMY RETRACTOR (JOE'S HOE)	191
WEINGARTNER EAR FORCEPS	297
WEISSBARTH SPECULUM & RETRACTOR	356
WEITLANER RETRACTOR	199-200
WELL BLAKESLEY LAMINECTOMY RONGEURS	331
WERTHEIM HAEMOSTATIC FORCEPS	111
WERTHEIM HAEMOSTATIC TISSUE FORCEPS	109
WERTHEIM HYSTERECTOMY FORCEPS	110
WERTHEIM NEEDLE HOLDERS	128
WERTHEIM NEEDLE HOLDERS T.C	136
WERTHEIM PARAMETRIUM CLAMP	110
WERTHEIM-CULLEN HAEMOSTATIC FORCEPS	111
WESTCOTT MICRO SCISSORS	49
WESTERMARK HAEMOSTATIC FORCEPS	106
WESTMACOTT NASAL POLYPUS AND SEPTUM FORCEPS	303
WHITE TONSIL SEIZING FORCEPS	316
WHITEHEAD MOUTH GAG	315
WIDE MOUTH EJECTOR KERRISON LAMINECTOMY RONGEURS	334, 338
WIEDER TONGUE DEPRESSOR	314
WIENER HOOK & SKIN HOOK	159
WIENER NASAL SAW	310
WILDE INTERVERTEBRAL DISC RONGEURS	331
WILDE NASAL DRESSING FORCEPS	317
WILDER LACRIMAL DILATOR	157
WILLET-MARTEL HAEMOSTATIC FORCEPS	116
WILLIAM LACRIMAL PROBES	155
WILLIAMS GRASP FORCEPS	340
WILLIAMS STYLE MICRO DISC INTERVERTEBRAL DISC RONGEURS	333
WILLIGER CURETTE	229-230
WILLIGER ELEVATOR	233
WILLIGER MALLETS	215
WILLIGER HAMMER	214
WINDOW PLUG FOR BRONCHOSCOPES	322
WINKELMANN CIRCUMCISION CLAMPS	389
WINTER ABORTION FORCEPS	380
WIRE BENDING FORCEPS	244
WIRE CUTTING SCISSORS T/C INSERT	65
WIRE FORCEPS	261
WIRE GUIDE	283
WIRE RETAINING RETRACTOR	196
WIRE TIGHTENING NEEDLE HOLDERS T.C	142
WIRE TWISTERS NEEDLE HOLDERS T.C	142
WOLFF SPREADER PLASTER	59
WRENCH DOUBLE ENDED	324
WRENCH KIRSCHNER EXTENSION BOWS	288
WRIGLEY OBSTETRICAL FORCEPS	377
WULLSTEIN RETRACTOR	199
Y	
YANKAUER SUCTION TUBE	17
YASARGIL NERVE DURA HOOK RETRACTOR	328
YASARGIL SCISSORS	50
YEOMANN INTESTINAL POLYOUS GRASPING FORCEPS	345
YOUNG PROSTATIC RETRACTOR	383
Z	
ZAUFAJ-JANSEN BONE RONGEUR	249
ZIEGLER CILIA FORCEPS	80
ZÖLLNER, SUCTION TUBE	19
ZWEIFEL DOUBLE ENDED	372
ZWEIFEL NEEDLE HOLDERS T.C	149



SURGICAL SOURCES INDUSTRIES

We are manufacturer and supplier of surgical & Dental instruments

P.O. Box No. 1389. Small Industrial Estate,
Sialkot Pakistan.
Phone No. +92-52-3252946
Mobile No. +92-334-4893946

E-mail: info@surgicalsources.com
Website: www.surgicalsources.com
Yahoo ID: surgical.sources
Skype ID: surgical.soruces

